



US00D368872S

# United States Patent [19]

[11] Patent Number: Des. 368,872

Weder et al.

[45] Date of Patent: \*\*\* Apr. 16, 1996

[54] FLOWER POT COVER

[75] Inventors: Donald E. Weder; Joseph G. Straeter, both of Highland, Ill.

[73] Assignee: Highland Supply Corporation, Highland, Ill.

[\*] Notice: The portion of the term of this patent subsequent to Oct. 3, 2009, has been disclaimed.

[\*\*] Term: 14 Years

[21] Appl. No.: 3,195

[22] Filed: Jan. 5, 1993

1,065,486	6/1913	Washburn	.....	229/400
2,054,934	9/1936	Graffenberger	.....	229/1.5 B
2,102,510	12/1937	Cecil, 2d	.....	229/1.5 B
2,355,559	8/1944	Renner	.....	229/8
5,127,817	7/1992	Weder et al.	.....	425/383

### FOREIGN PATENT DOCUMENTS

103316	3/1938	Australia	.....	229/922
--------	--------	-----------	-------	---------

### OTHER PUBLICATIONS

Exhibit A-Speed Cover® Brochure-The Simple Solution . . . , ©1989.

Primary Examiner—Jeffrey Asch  
Attorney, Agent, or Firm—Dunlap & Coddling

### [57] CLAIM

The ornamental design for a flower pot cover, as shown and described.

### Related U.S. Application Data

[63] Continuation-in-part of Ser. No. 807,683, Dec. 16, 1991, which is a continuation-in-part of Ser. No. 710,272, Jun. 4, 1991, which is a continuation-in-part of Ser. No. 617,454, Nov. 21, 1990, abandoned, said Ser. No. 710,272, is a continuation-in-part of Ser. No. 411,249, Sep. 22, 1989, Pat. No. Des. 358,113, said Ser. No. 710,272, is a continuation-in-part of Ser. No. 411,247, Sep. 22, 1989, said Ser. No. 710,272, is a continuation-in-part of Ser. No. 411,245, Sep. 22, 1989.

[52] U.S. Cl. .... D11/164; D11/152

[58] Field of Search ..... D11/143, 149, D11/152-156, 164, 89, 90; 47/66, 72; 206/423; 215/100.5; 229/1.5 R, 1.5 B, 4.5, 87.01, 922, 930, 108, 108.1, 109, 110, 400; 428/27, 35.1, 24, 542.6; D9/346, 428-431; D27/102, 133; D26/128-136; D19/96; D7/540, 584, 586, 587, 354

### [56] References Cited

#### U.S. PATENT DOCUMENTS

D. 292,182	10/1987	Weder et al.	.....	D11/164
D. 292,562	11/1987	Weder et al.	.....	D11/164
D. 293,224	12/1987	Weder et al.	.....	D11/164
D. 293,775	1/1988	Weder et al.	.....	D11/164
D. 313,575	1/1991	Weder et al.	.....	D11/164
D. 317,583	6/1991	Weder et al.	.....	D11/164
D. 318,030	7/1991	Weder et al.	.....	D11/164
D. 327,234	6/1992	Vaughn	.....	D11/143

### DESCRIPTION

FIG. 1 is a perspective view of our new flower pot cover design;  
 FIG. 2 is a side elevational view thereof;  
 FIG. 3 is a top plan view thereof;  
 FIG. 4 is a bottom plan view thereof;  
 FIG. 5 is a side elevational view of the design of FIG. 1, the only difference being in the horizontal angle of the skirt;  
 FIG. 6 is a side elevational view of the design of FIG. 1, the only difference being in the near vertical angle of the skirt;  
 FIG. 7 is a side elevational view of the design of FIG. 1, the only difference being in the downward angle of the skirt;  
 FIG. 8 is a perspective view of a second embodiment of our new flower pot cover design;  
 FIG. 9 is a side elevational view thereof;  
 FIG. 10 is a top plan view thereof;  
 FIG. 11 is bottom plan view thereof;  
 FIG. 12 is a side elevational view of the design of FIG. 8, the only difference being in the horizontal angle of the skirt;  
 FIG. 13 is a side elevational view of the design of FIG. 8, the only difference being in the near vertical angle of the skirt;  
 FIG. 14 is a side elevational view of the design of FIG. 8, the only difference being in the downward angle of the skirt;  
 FIG. 15 is a perspective view of a third embodiment of our new flower pot cover design;

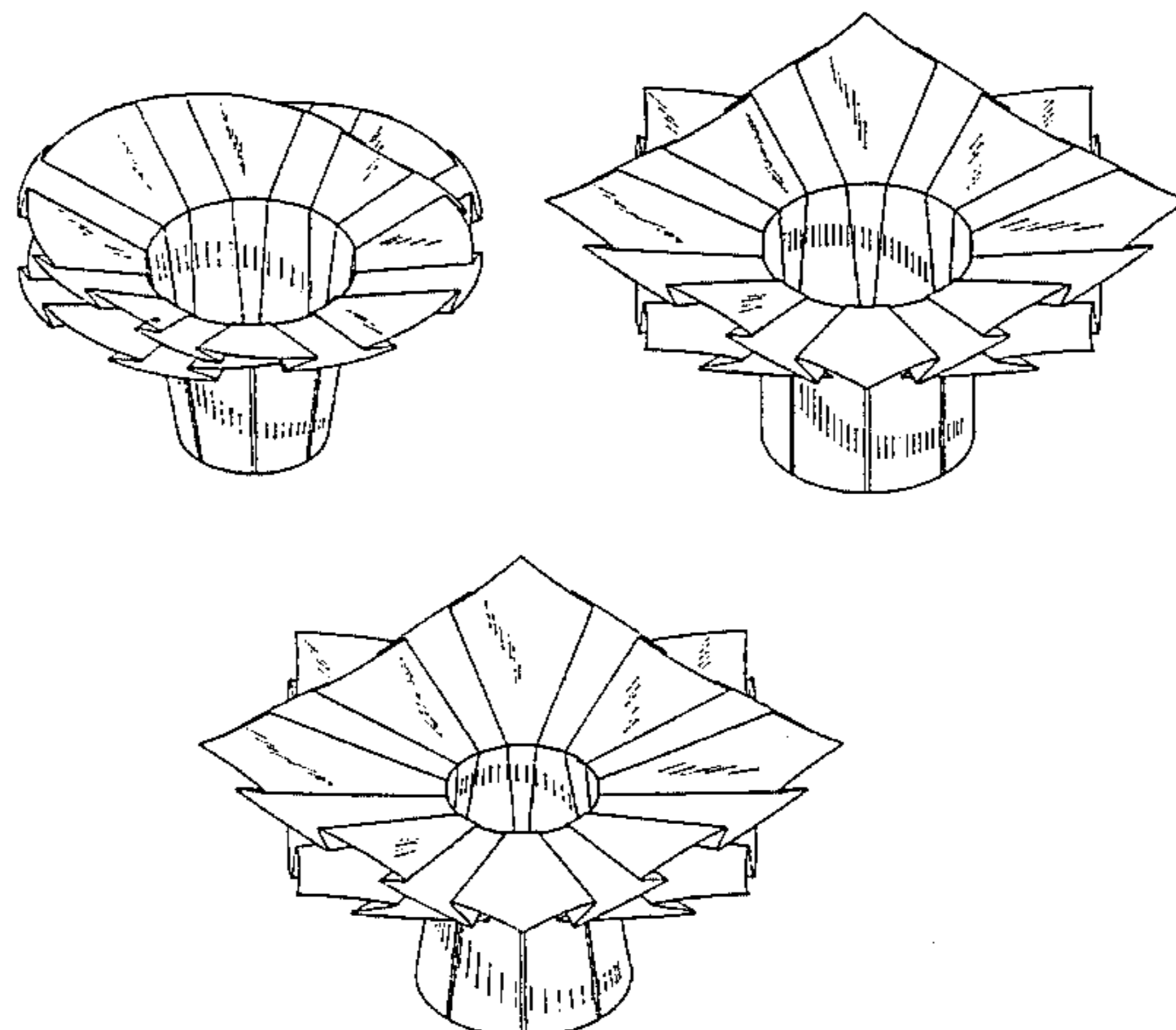

FIG. 16 is a side elevational view thereof;  
FIG. 17 is a top plan view thereof;  
FIG. 18 is a bottom plan view thereof;  
FIG. 19 is a side elevational view of the design of FIG. 15, the only difference being in the horizontal angle of the skirt;  
FIG. 20 is a side elevational view of the design of FIG. 15, the only difference being in the near vertical angle of the skirt;  
FIG. 21 is a side elevational view of the design of FIG. 15, the only difference being in the downward angle of the skirt;  
FIG. 22 is a perspective view of a fourth embodiment of our new flower pot cover design;  
FIG. 23 is a side elevational view thereof;  
FIG. 24 is a top plan view thereof;  
FIG. 25 is a bottom plan view thereof;  
FIG. 26 is a side elevational view of the design of FIG. 22, the only difference being in the horizontal angle of the skirt;  
FIG. 27 is a side elevational view of the design of FIG. 22, the only difference being in the near vertical angle of the skirt;

FIG. 28 is a side elevational view of the design of FIG. 22, the only difference being in the downward angle of the skirt;  
FIG. 29 is a perspective view of a fifth embodiment of our new flower pot cover design;  
FIG. 30 is a side elevational view thereof;  
FIG. 31 is a top plan view thereof;  
FIG. 32 is bottom plan view thereof;  
FIG. 33 is a side elevational view of the design of FIG. 29, the only difference being in the horizontal angle of the skirt;  
FIG. 34 is a side elevational view of the design of FIG. 29, the only difference being in the near vertical angle of the skirt; and,  
FIG. 35 is a side elevational view of the design of FIG. 29, the only difference being in the downward angle of the skirt. The characteristic feature of the design resides in the specific pleating arrangement, comprised of the parallel disposition of the exterior folds, in combination with the interior V-shaped folds, all as best seen in FIGS. 1, 8, 15, 22 and 29.

**1 Claim, 7 Drawing Sheets**

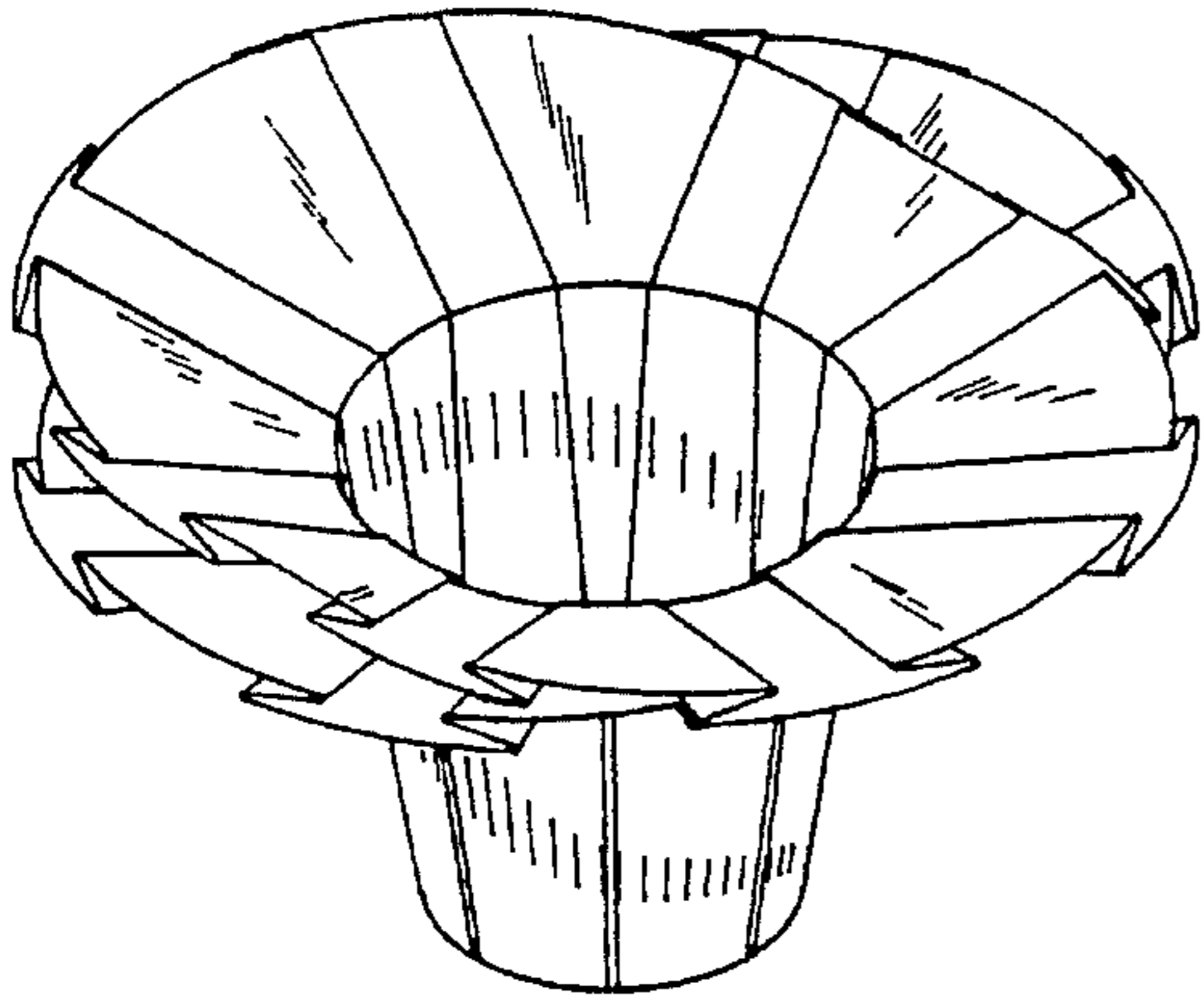

FIG. 1

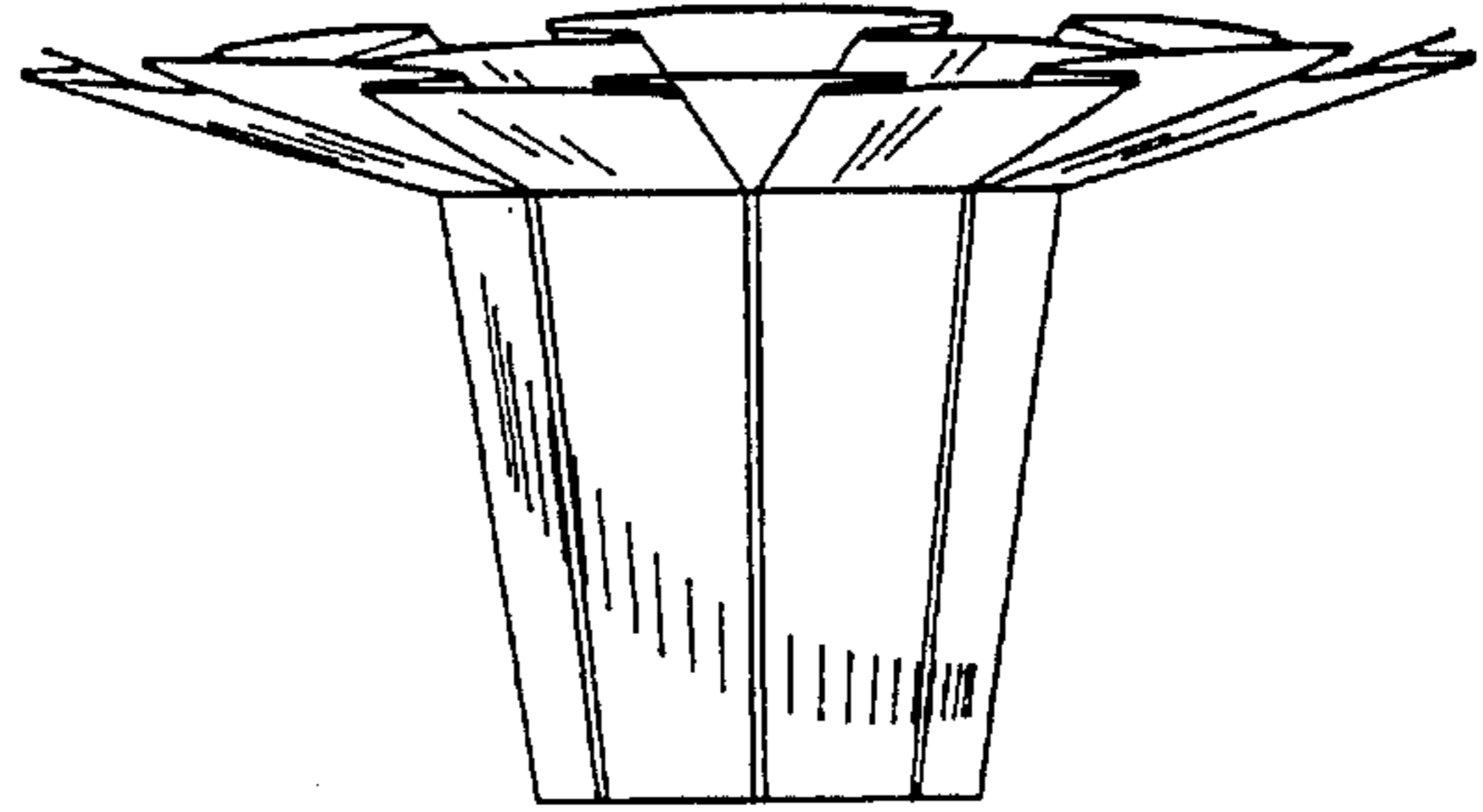

FIG. 2

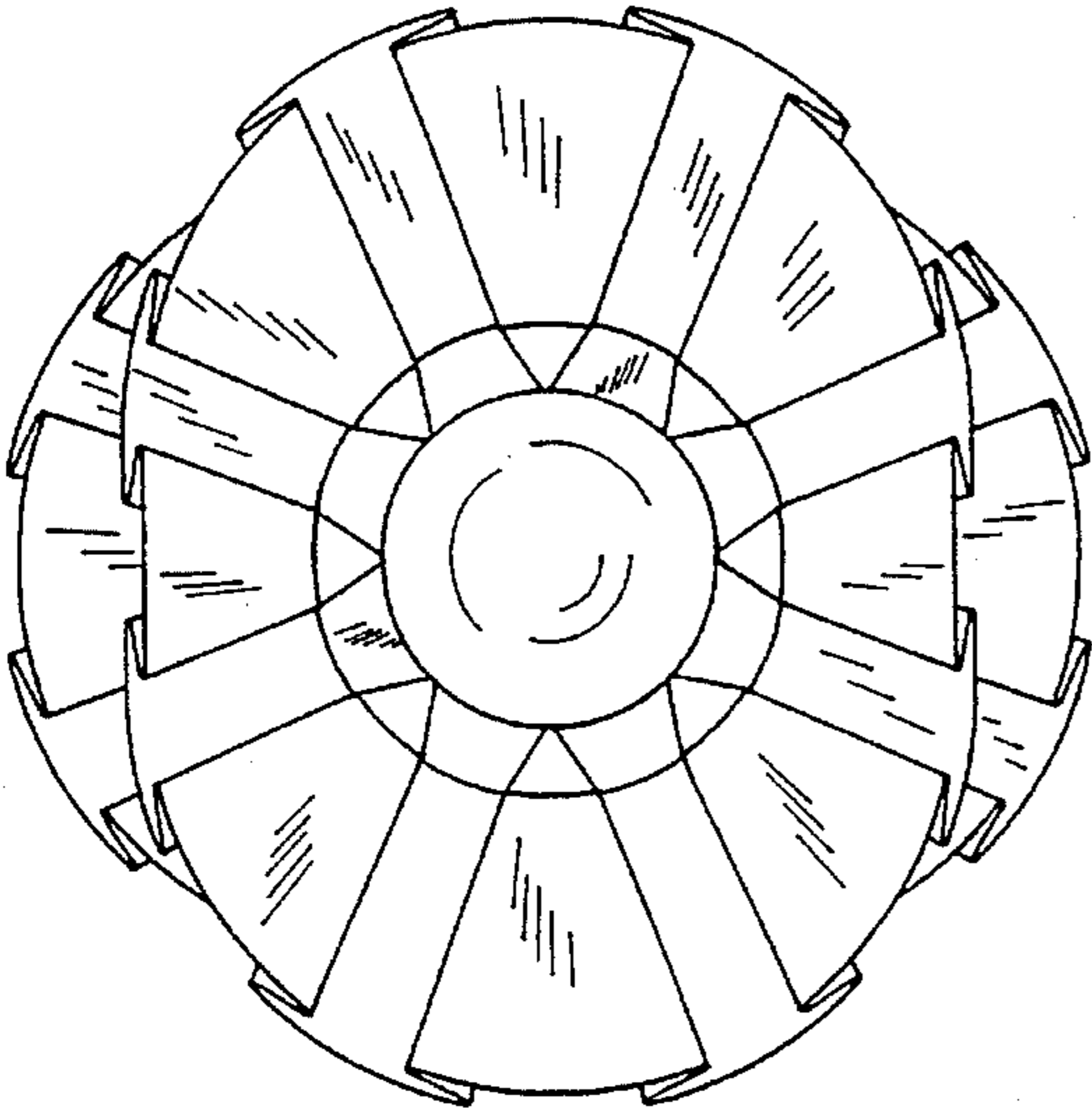

FIG. 3

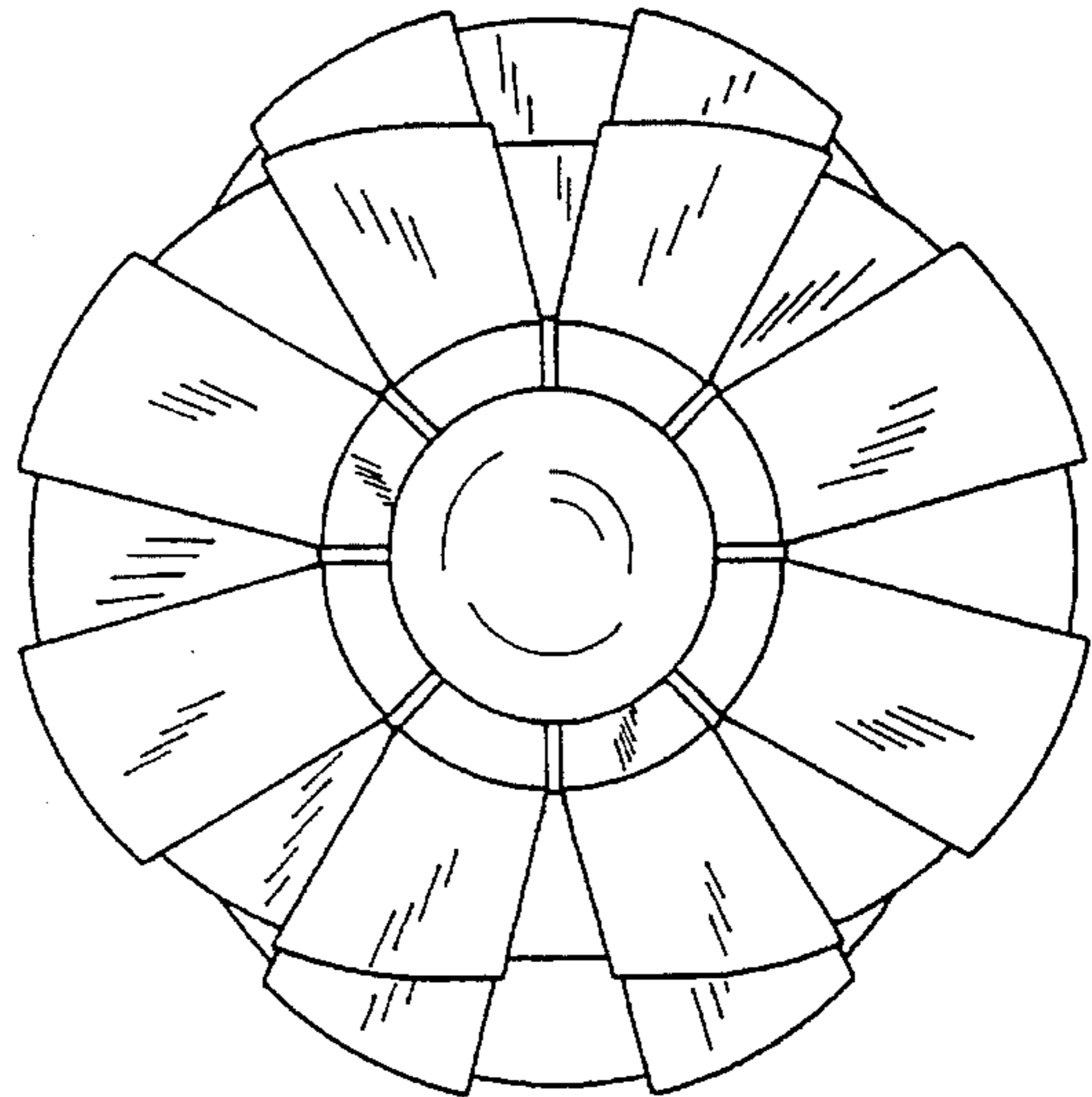

FIG. 4

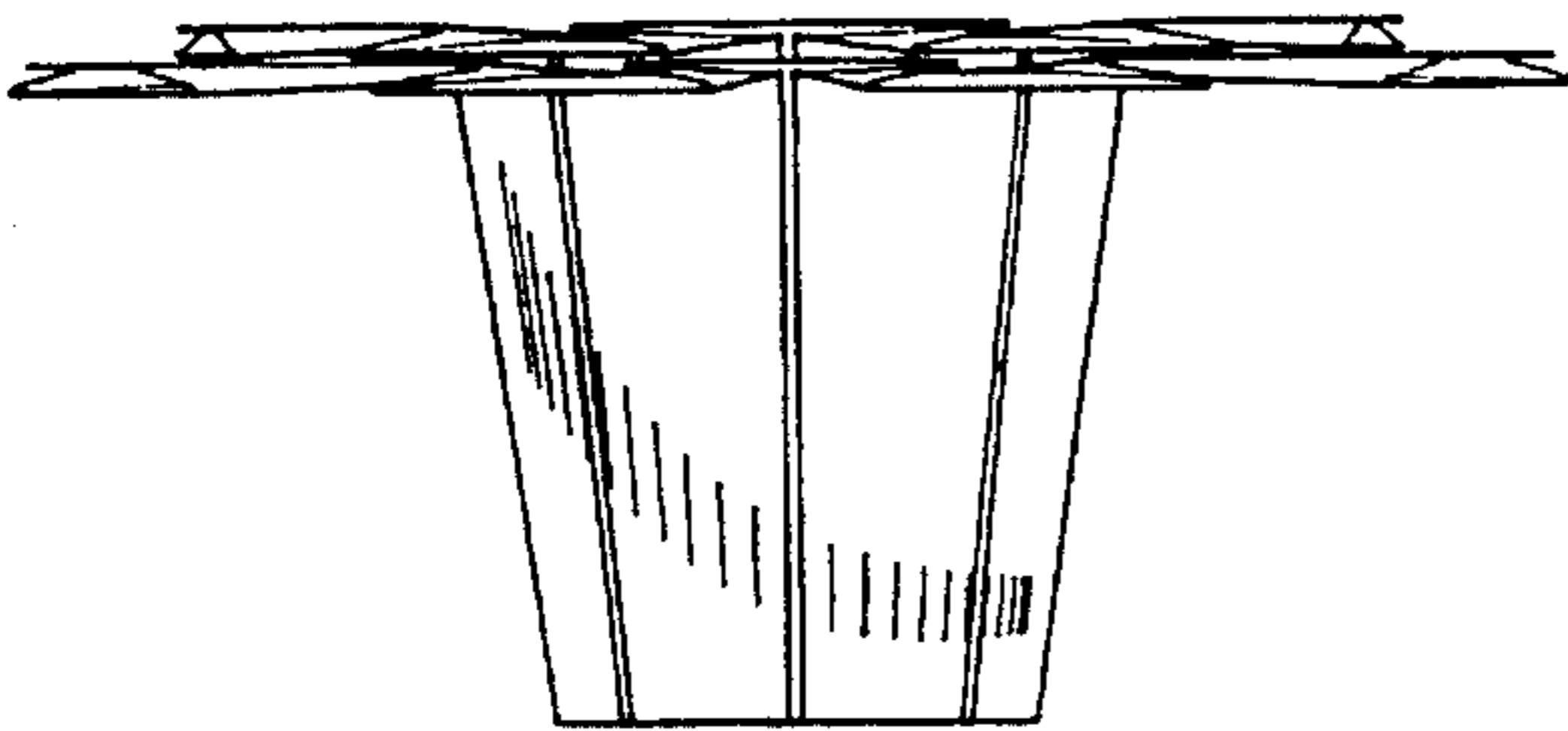

FIG. 5

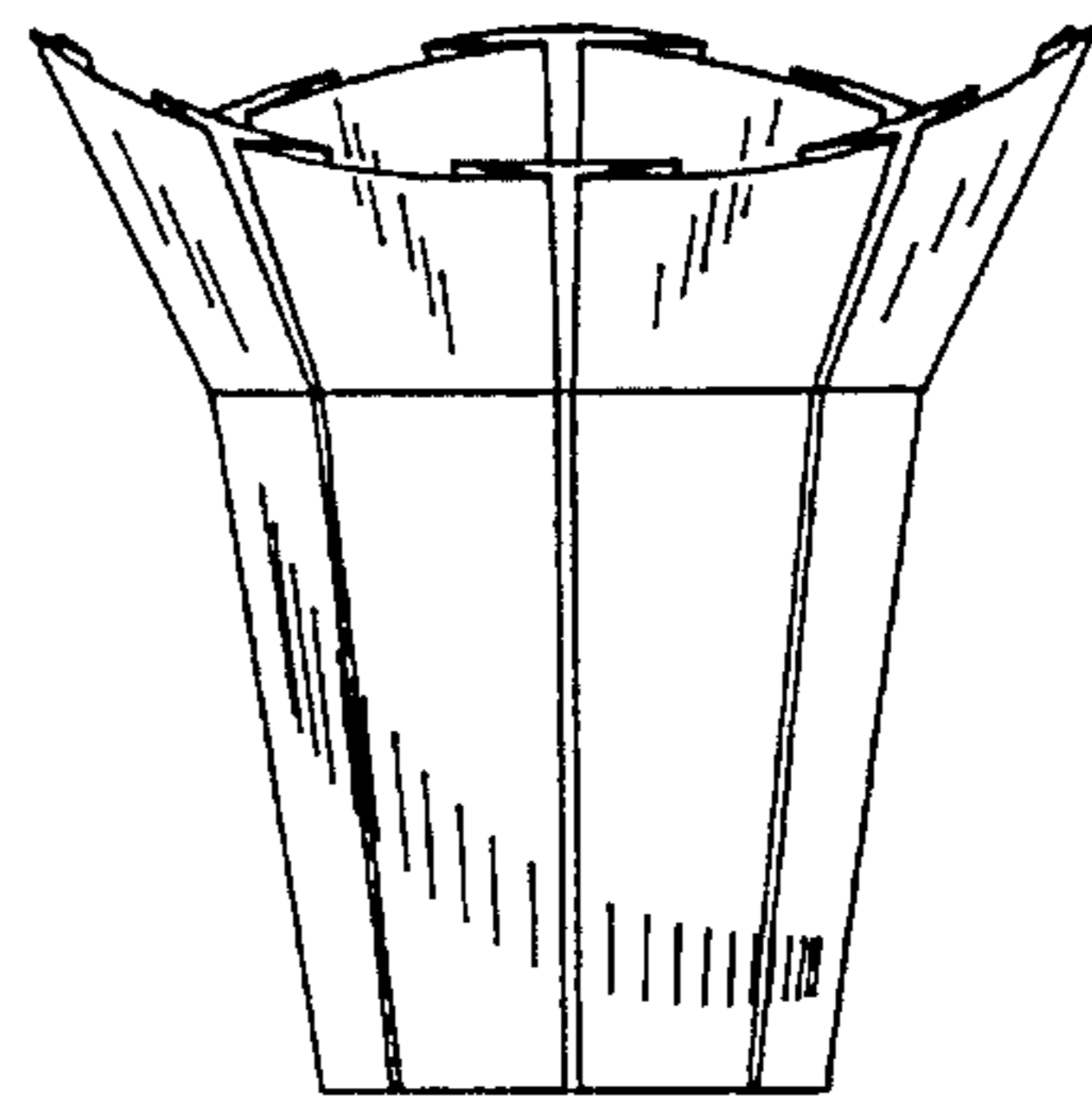

FIG. 6

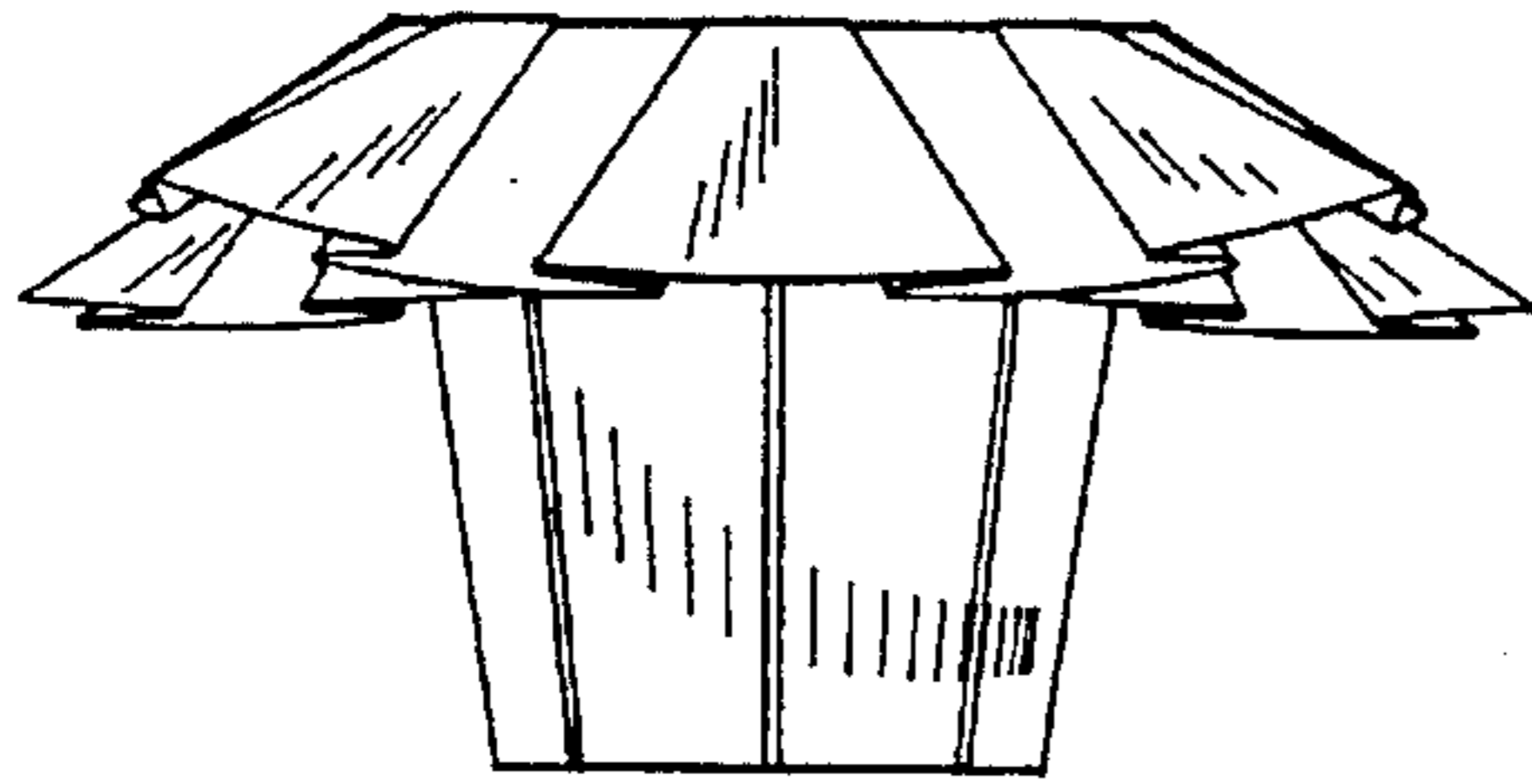

FIG. 7

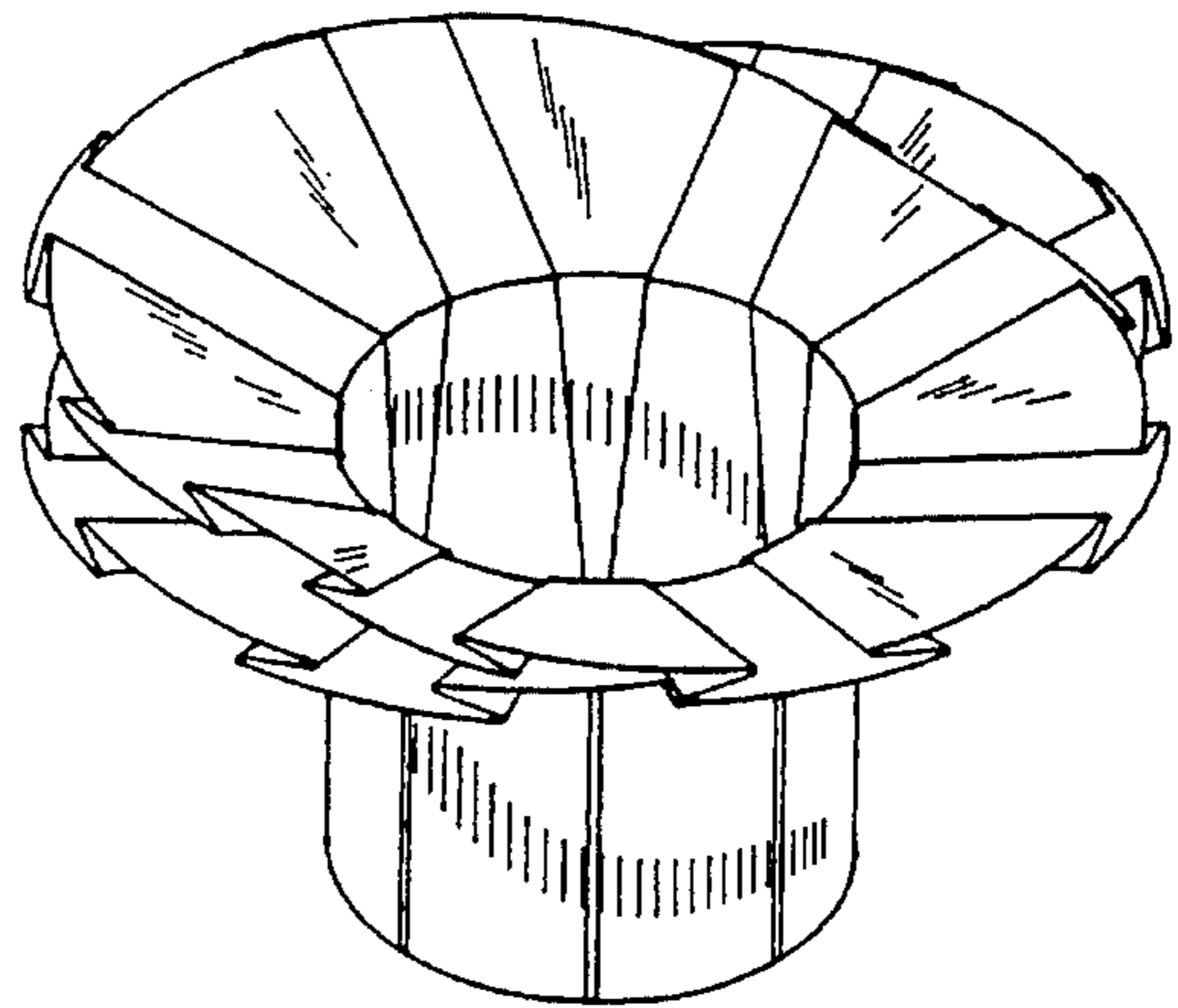

FIG. 8

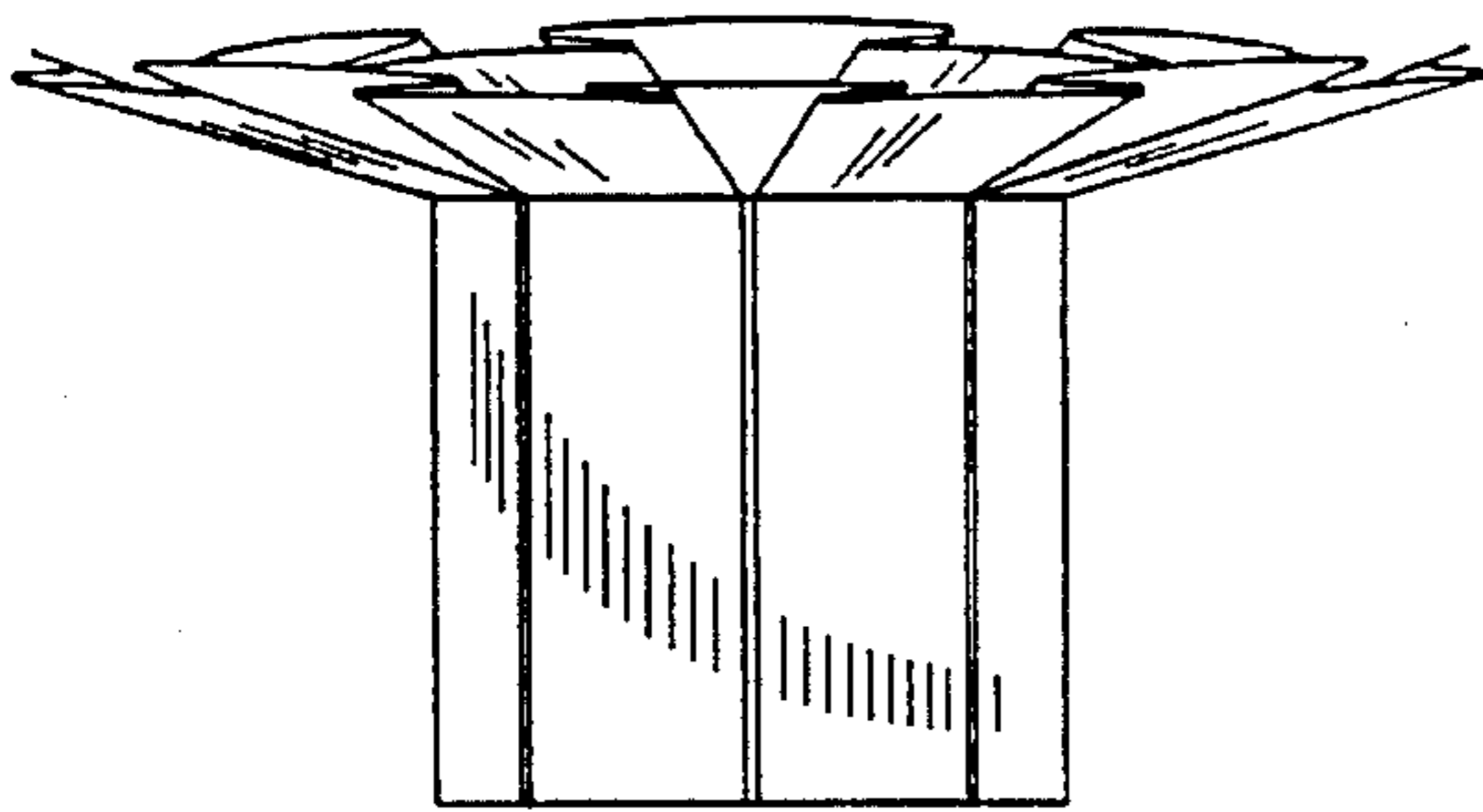

FIG. 9

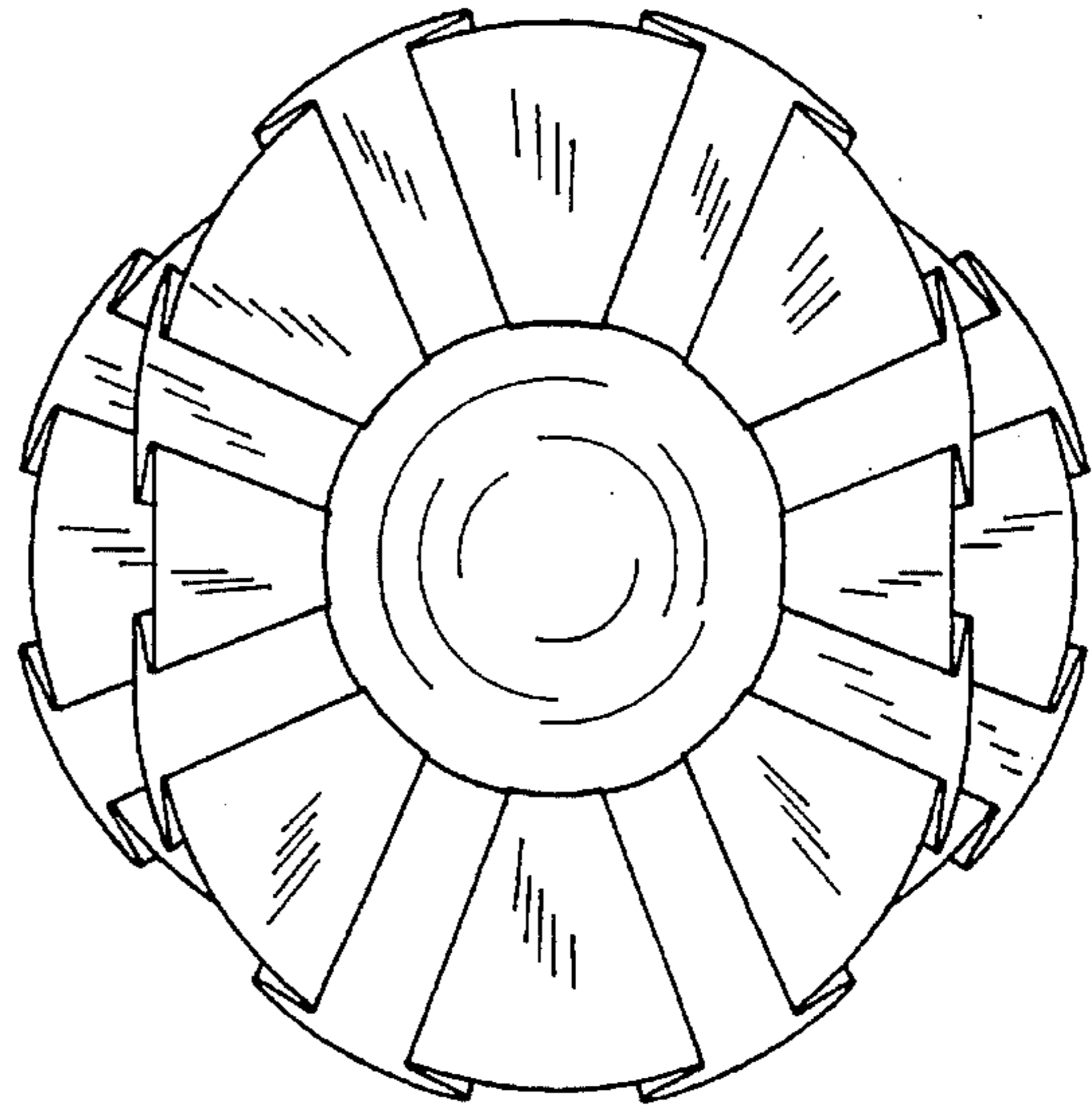

FIG. 10

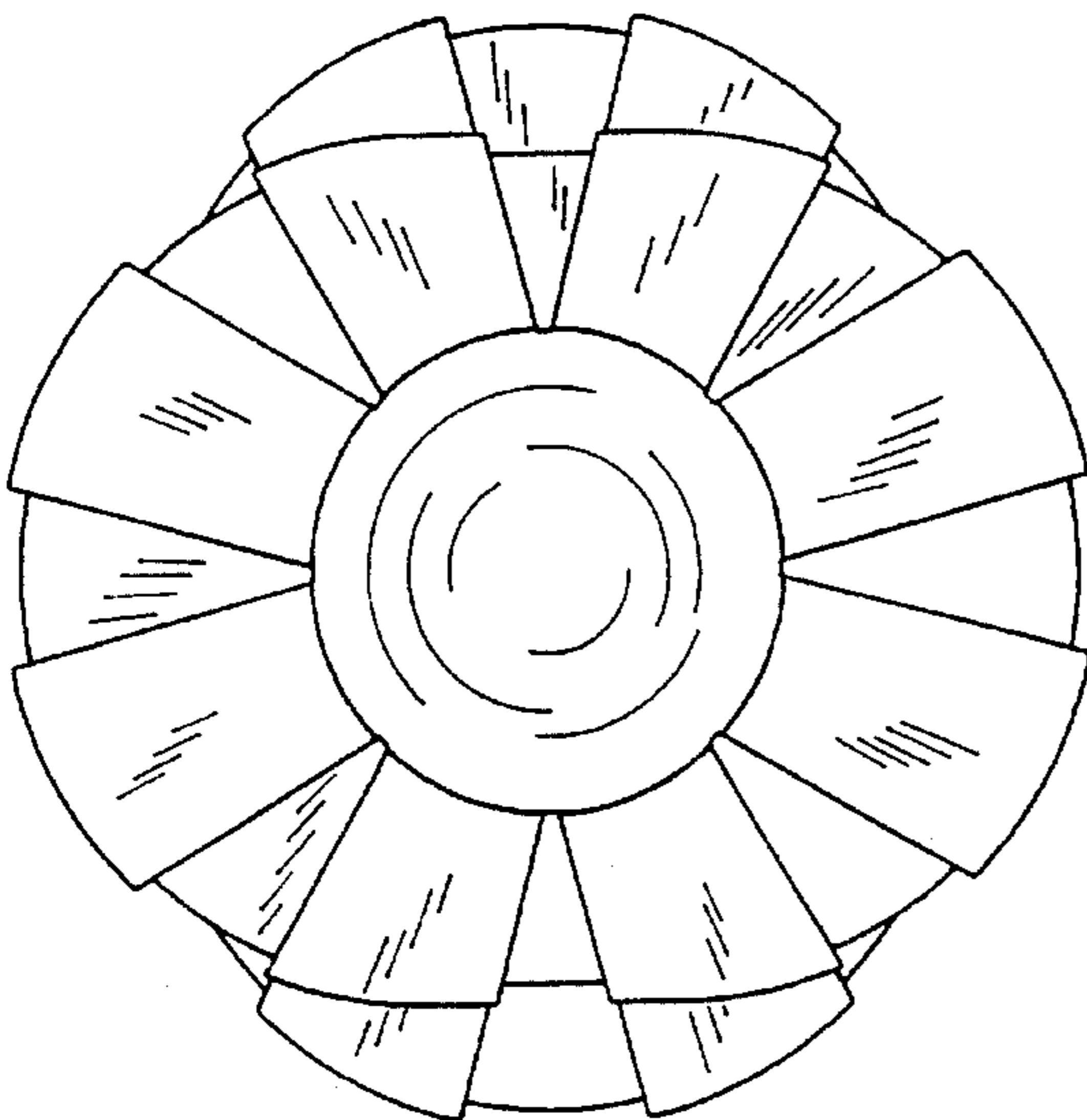

FIG. 11

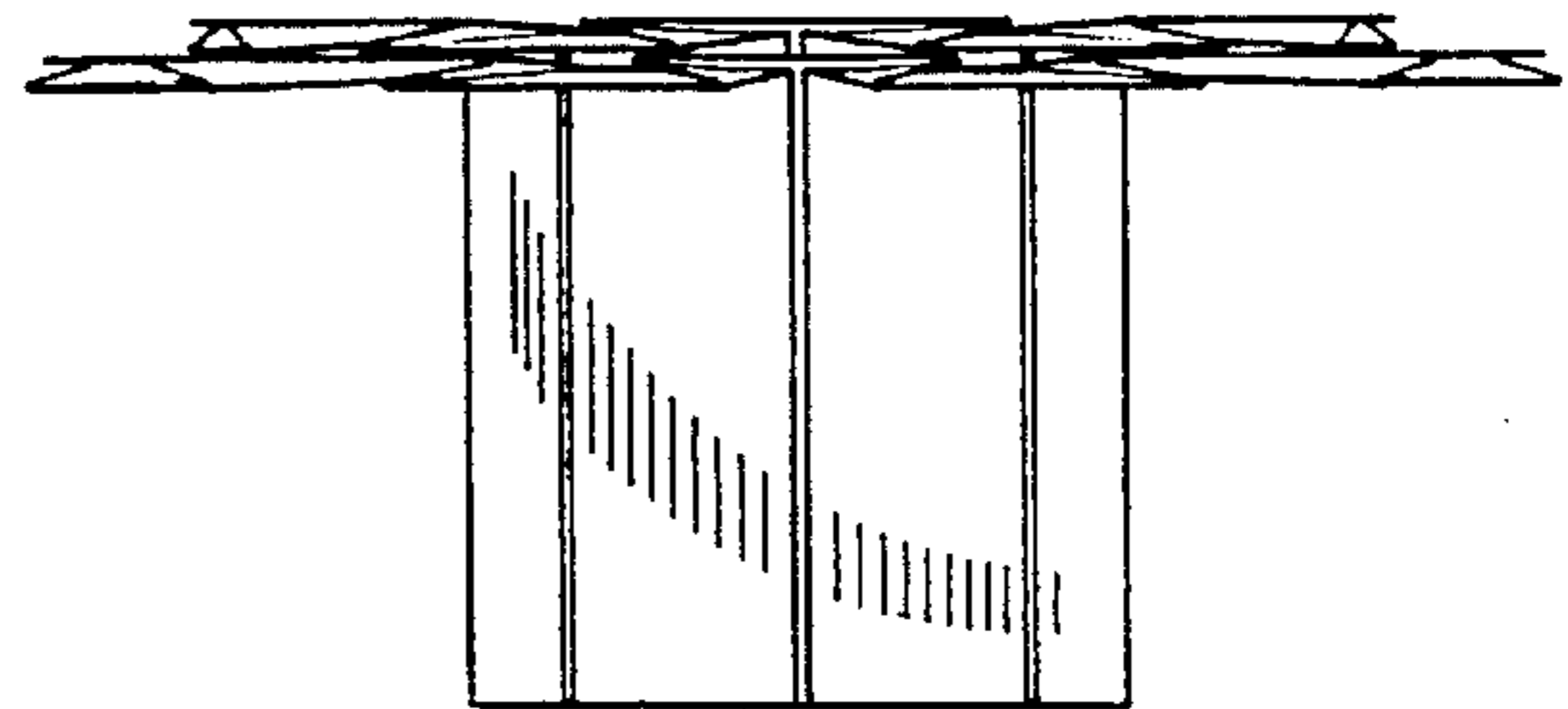

FIG. 12

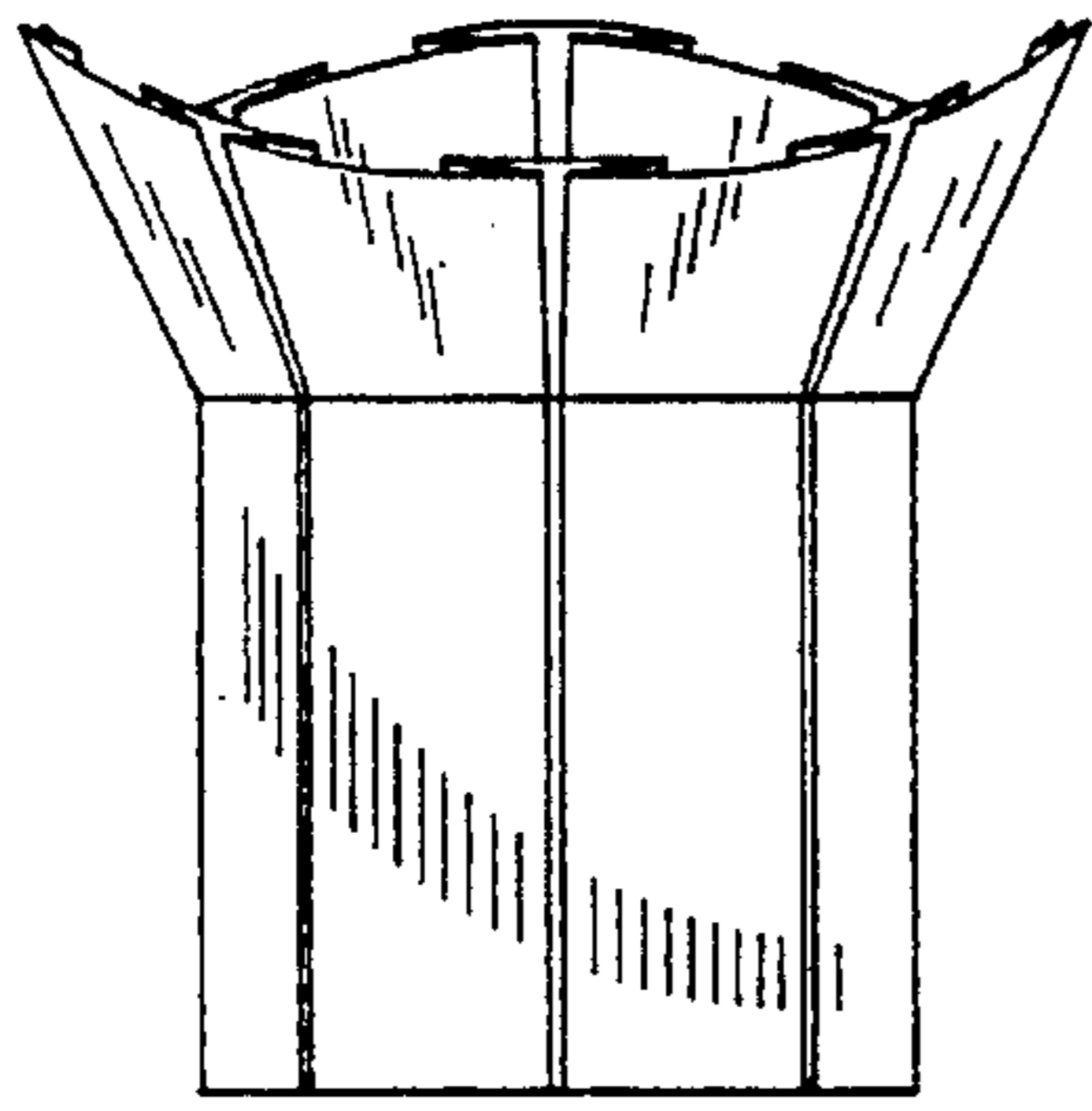

FIG. 13

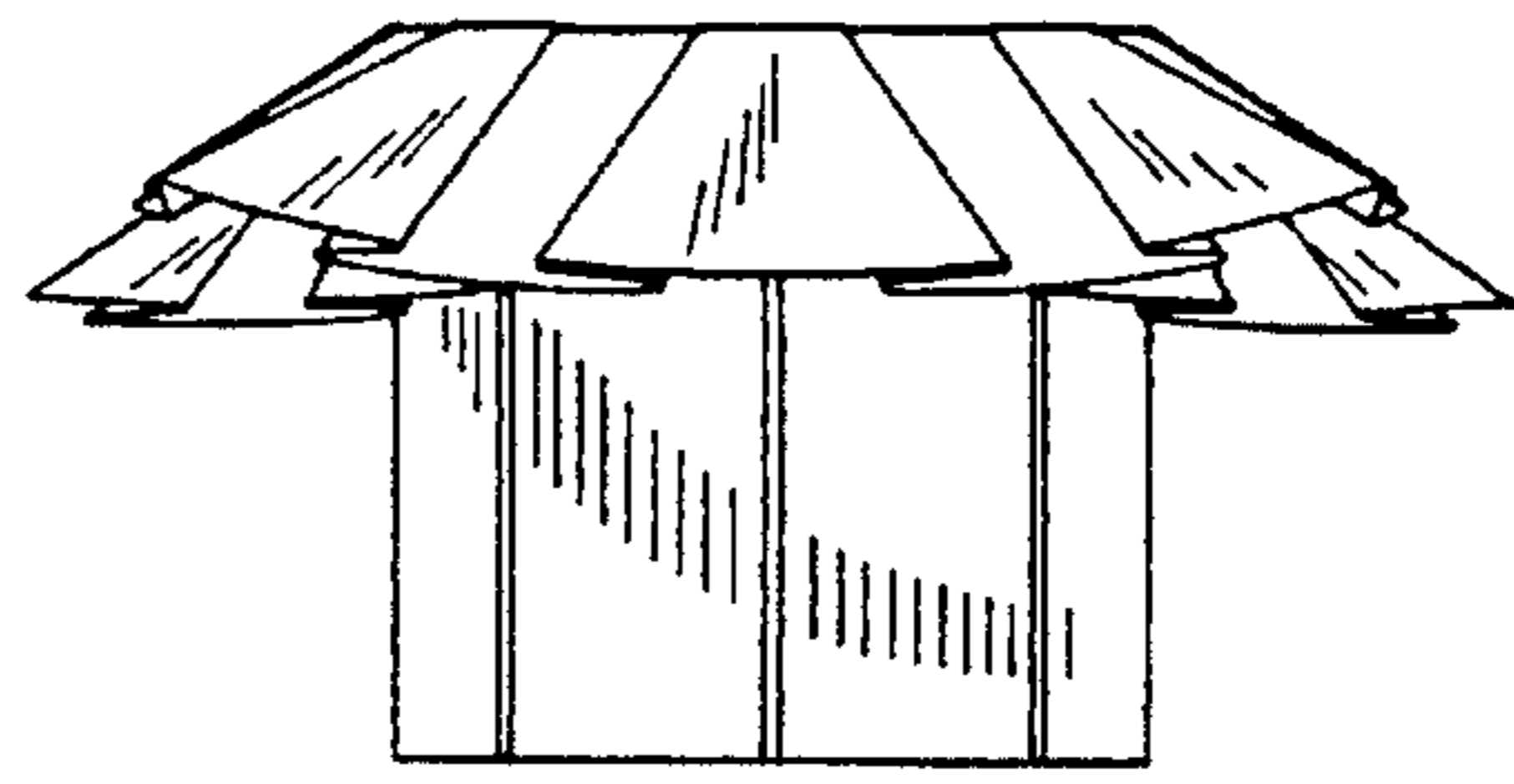

FIG. 14

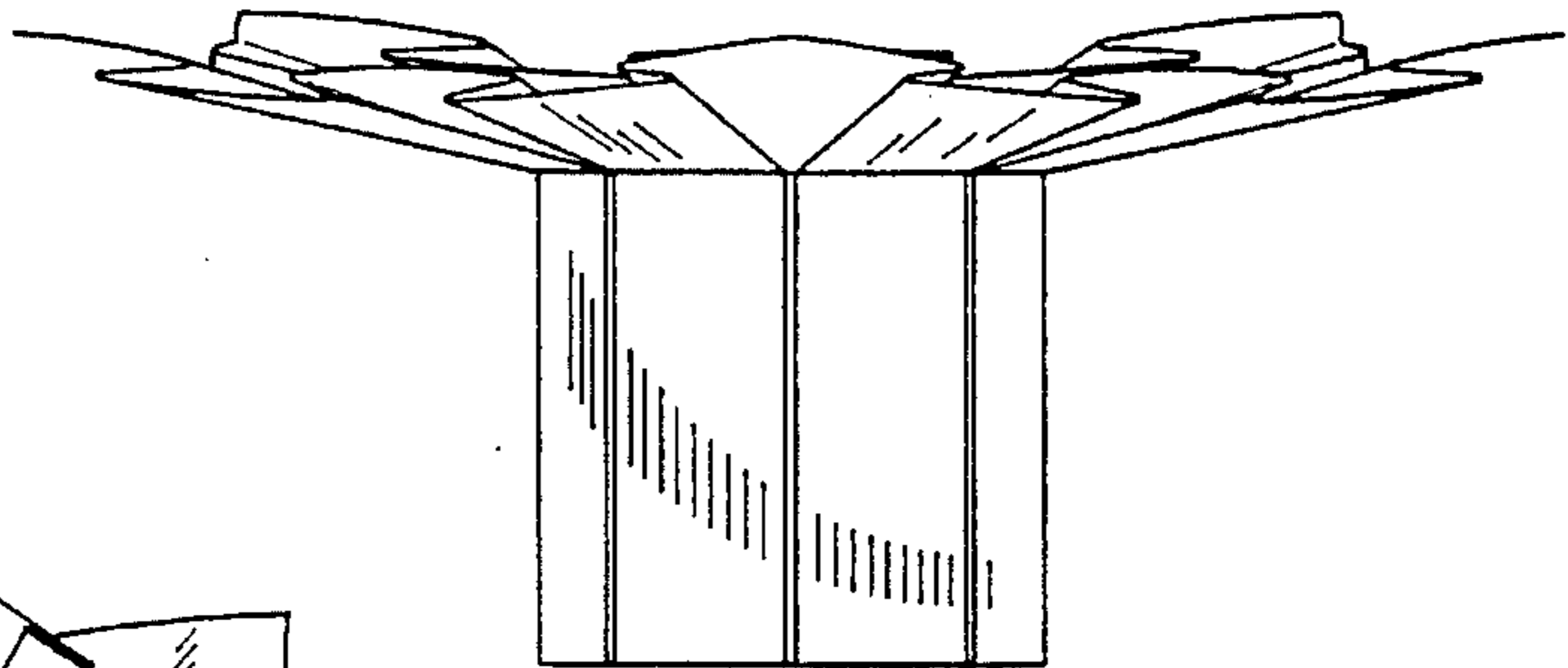

FIG. 16

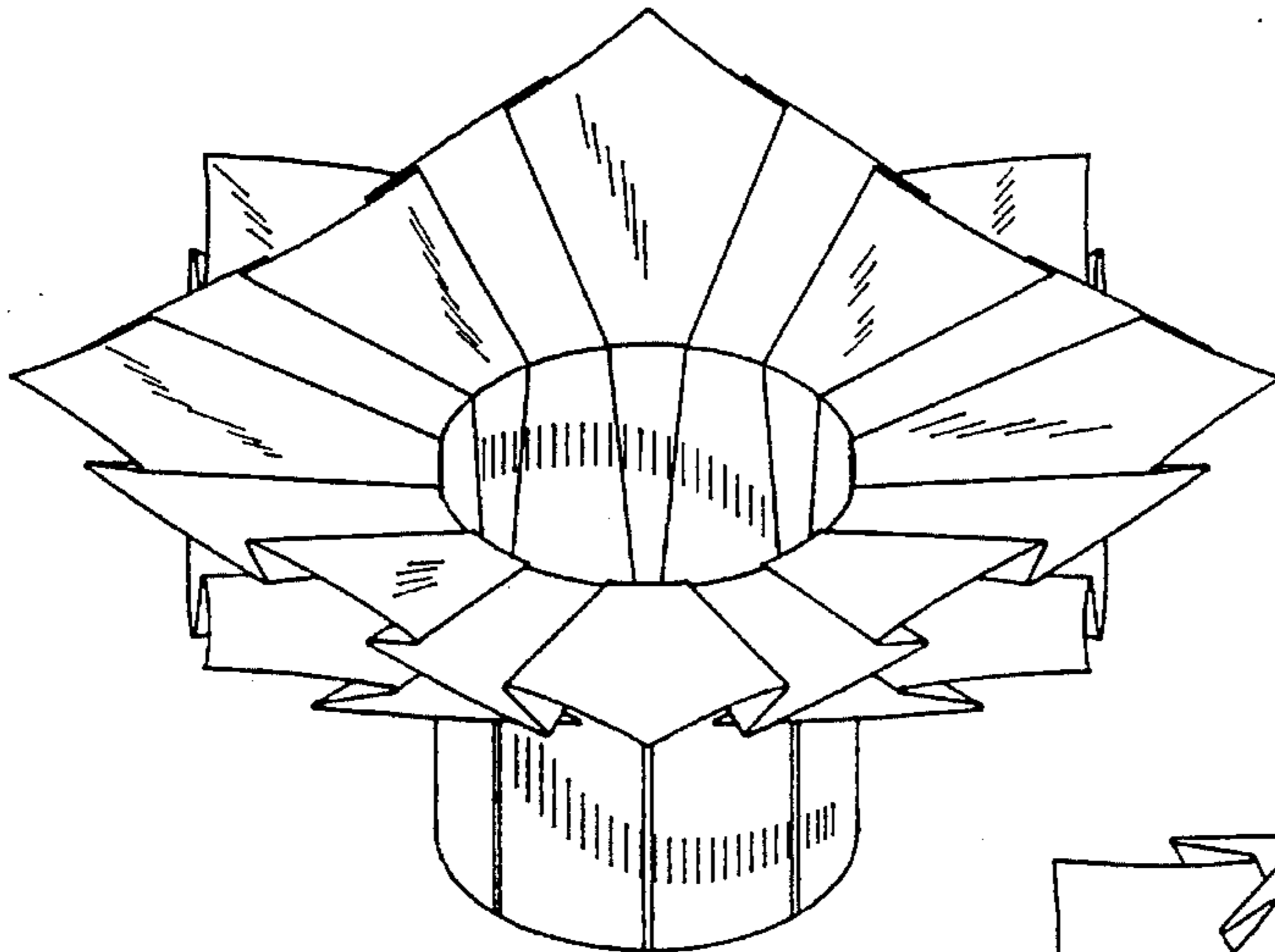

FIG. 15

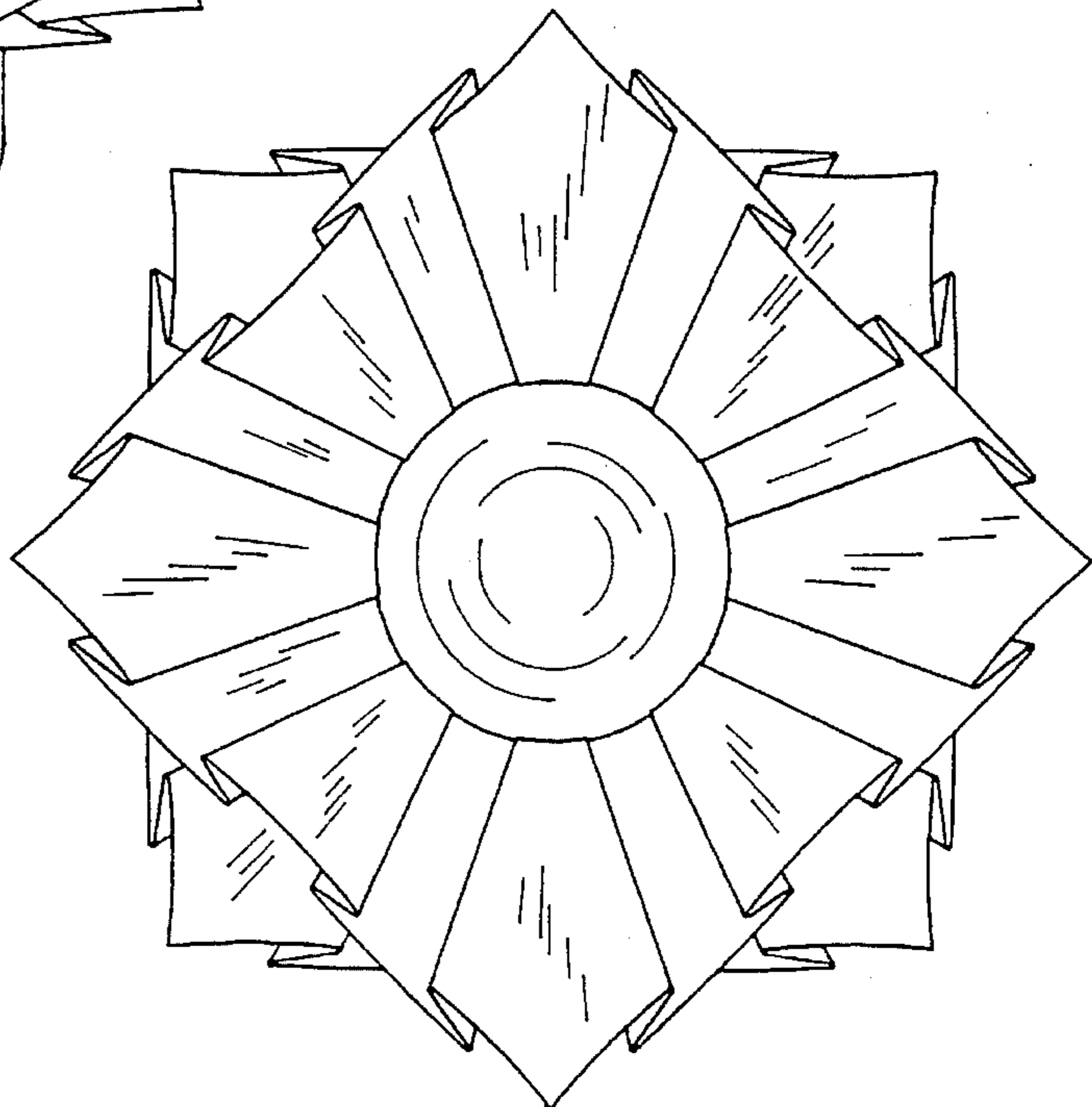

FIG. 17

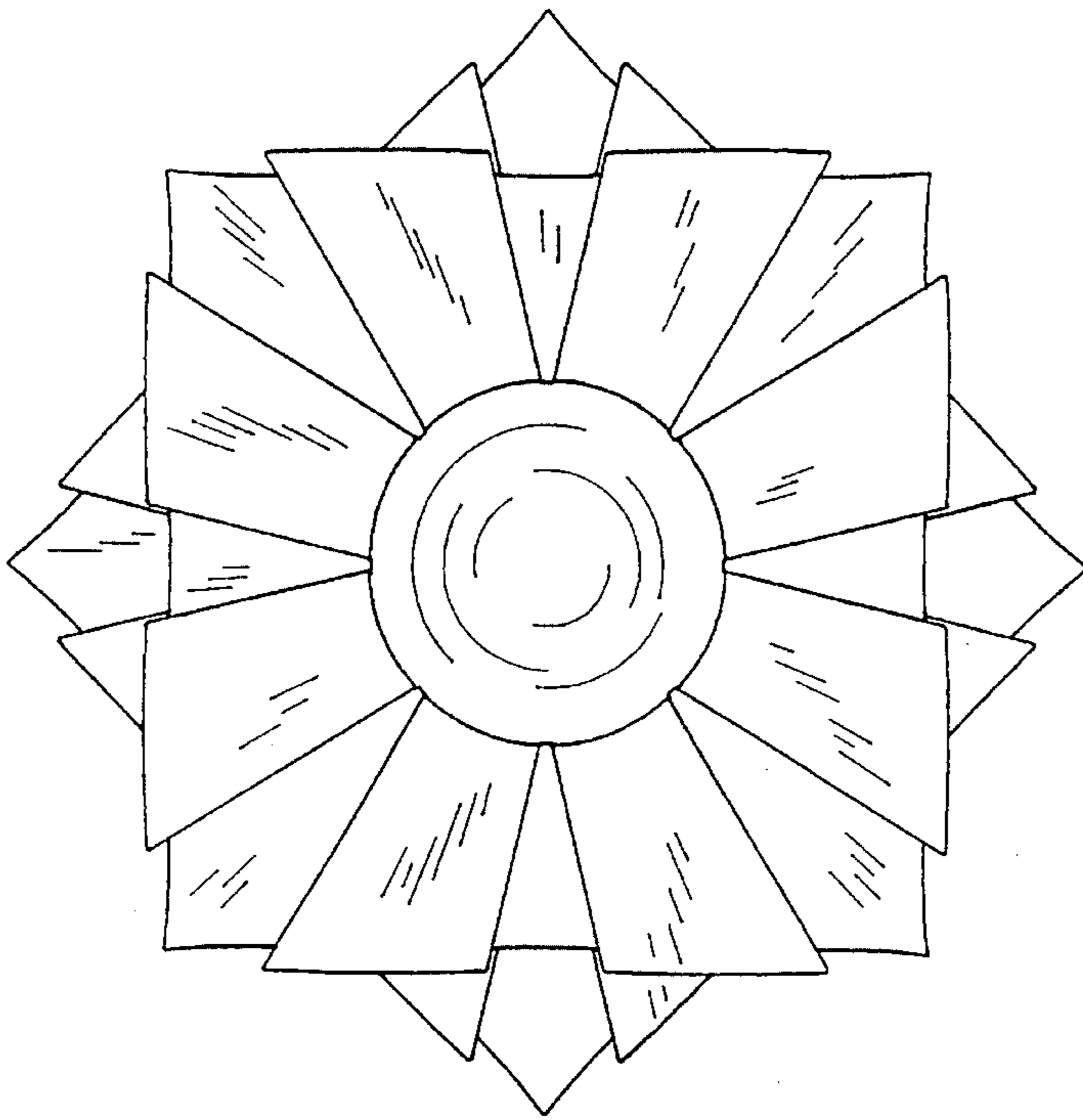

FIG. 18

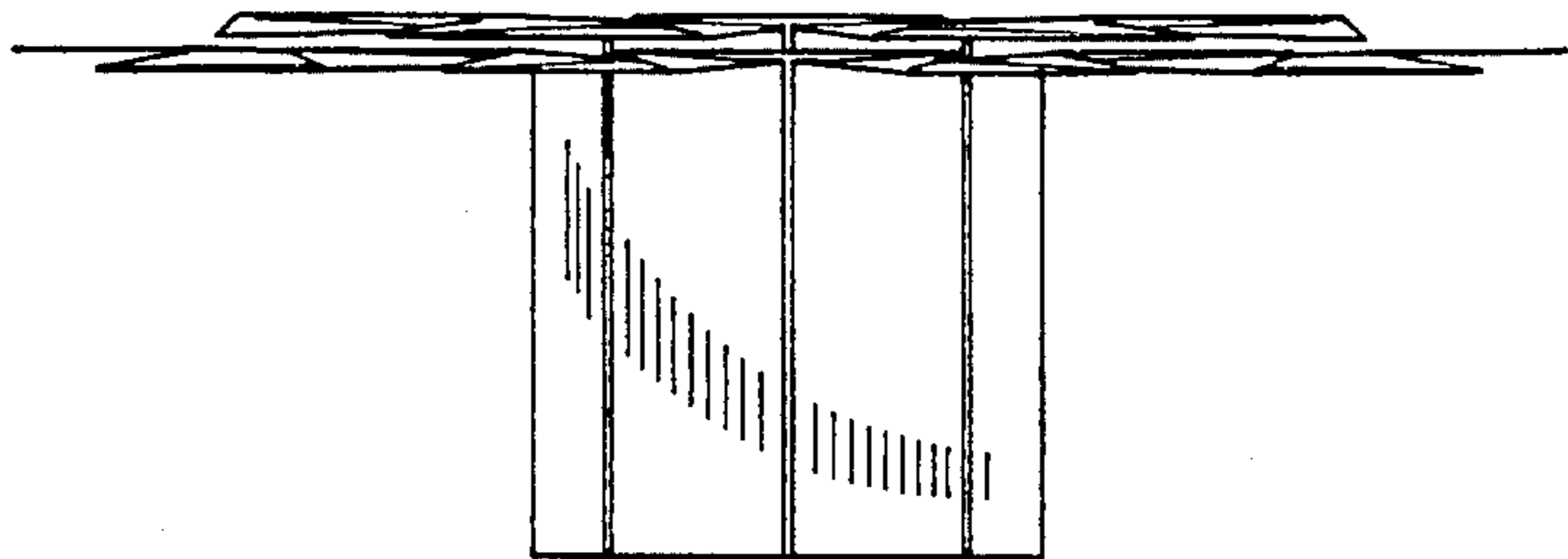

FIG. 19

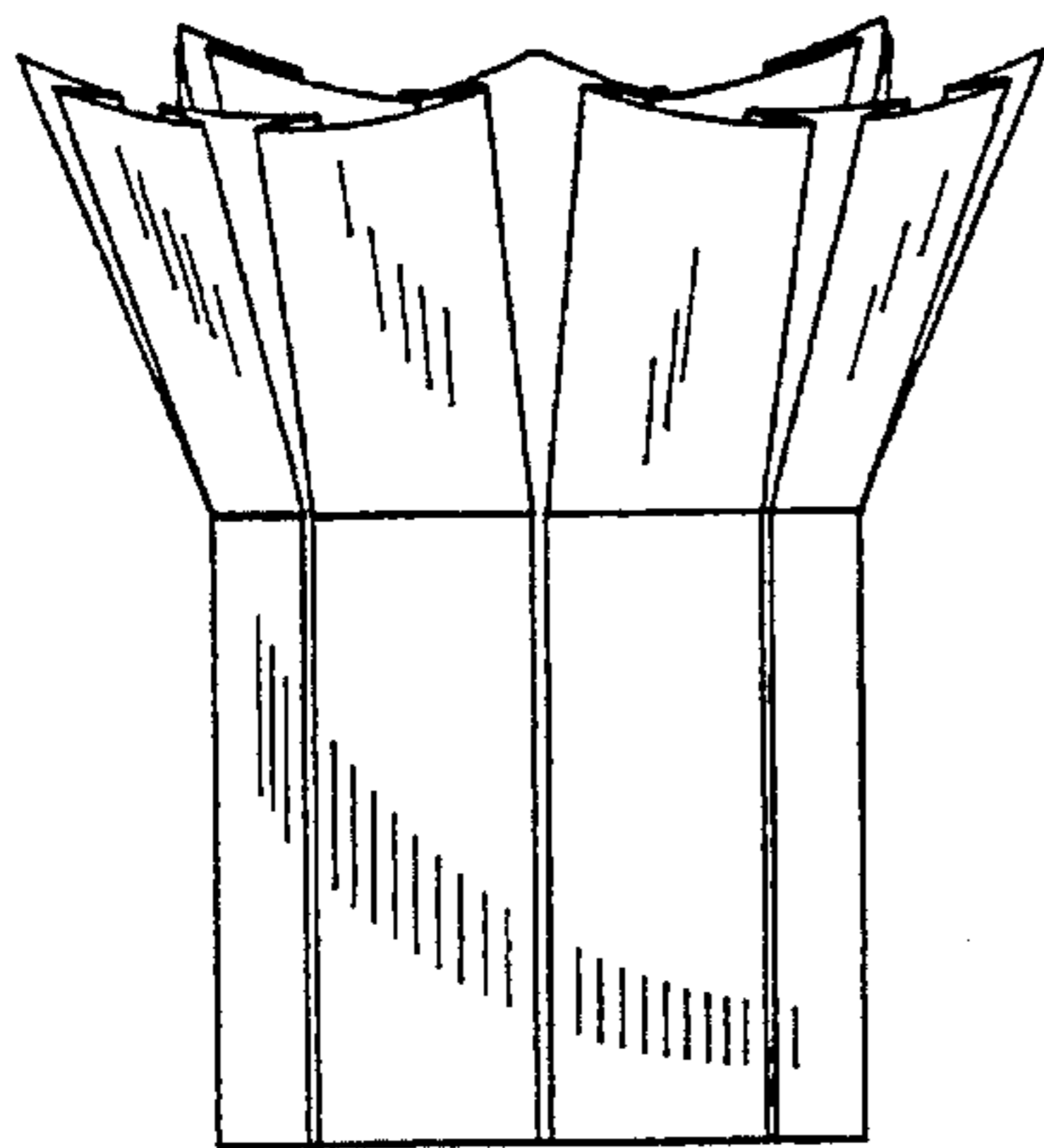

FIG. 20

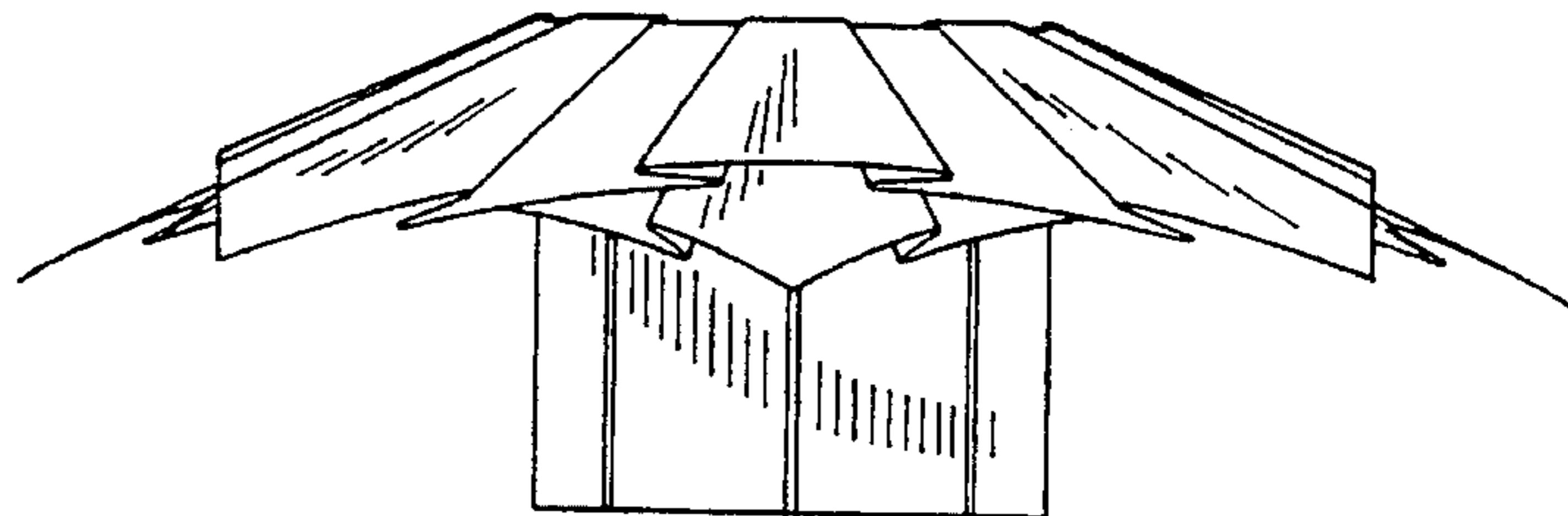

FIG. 21

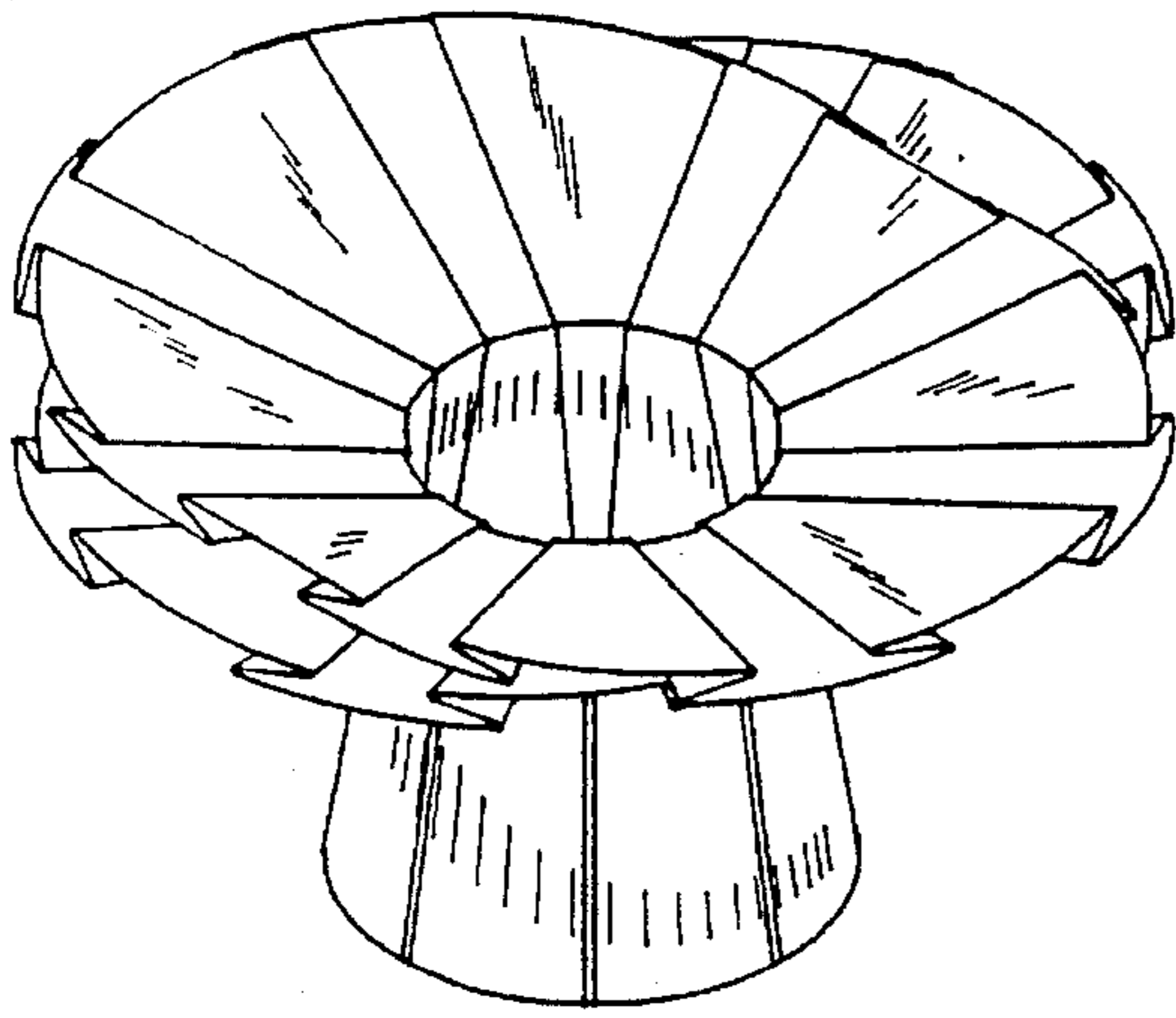

FIG. 22

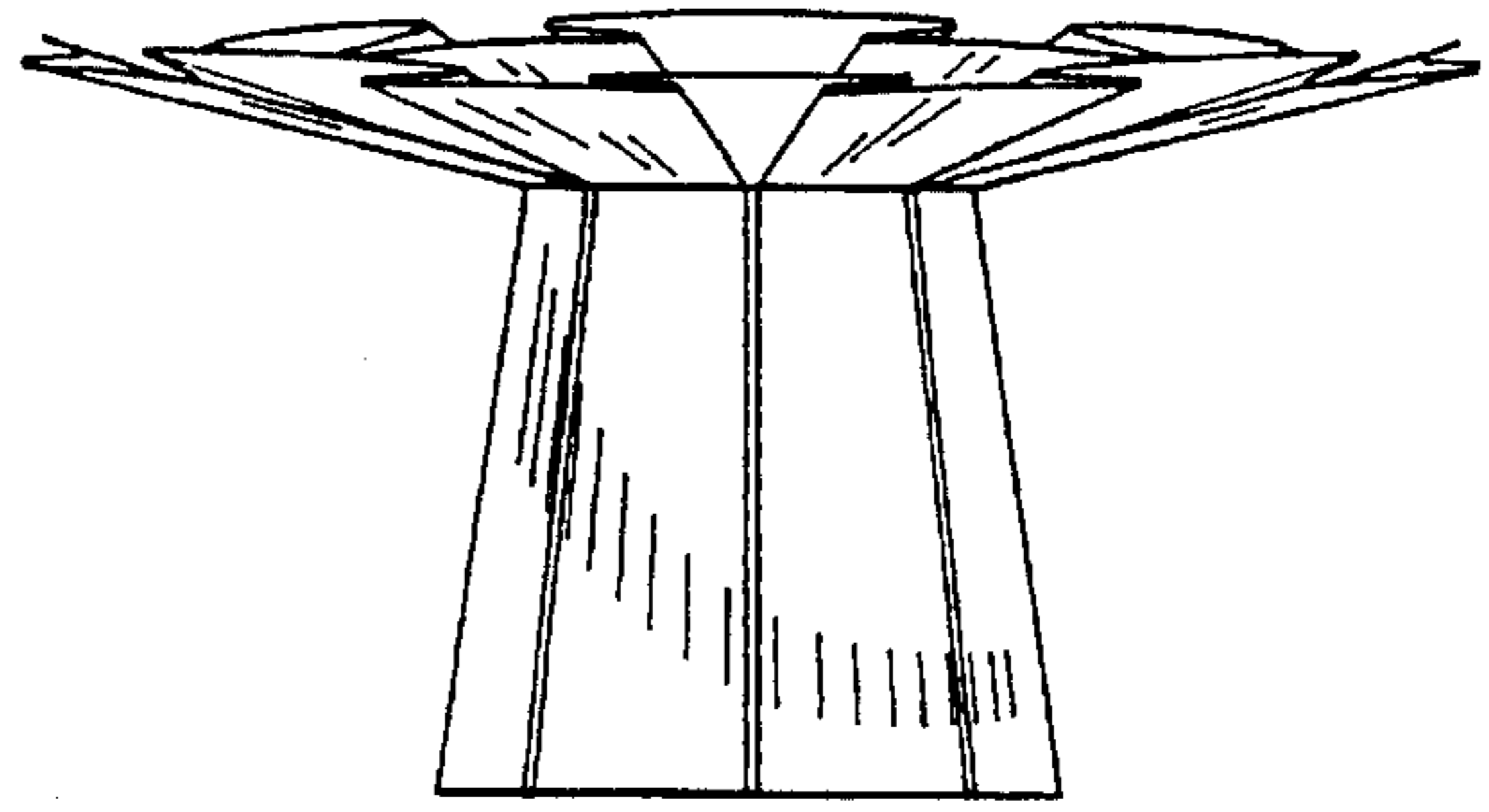

FIG. 23

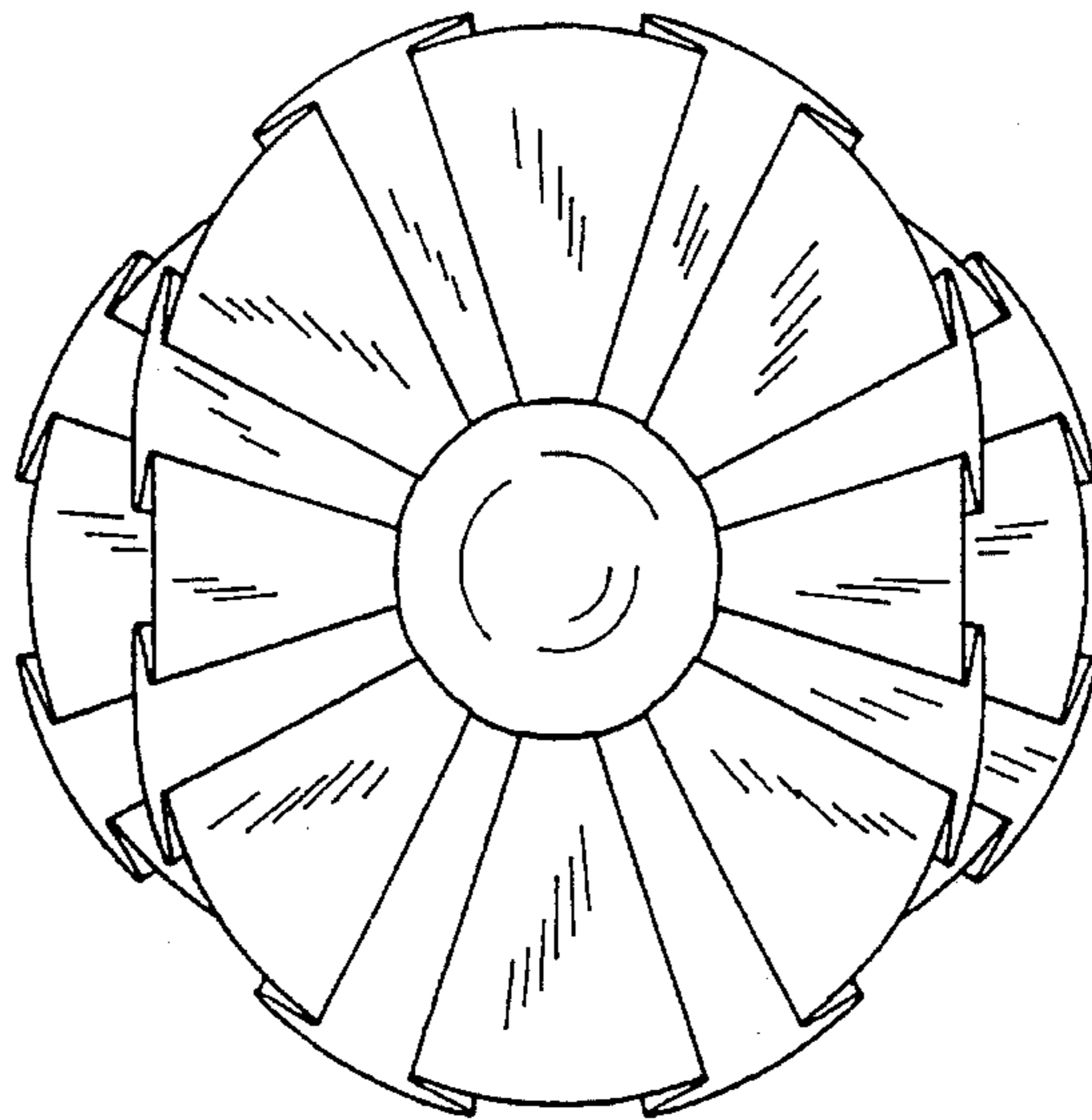

FIG. 24

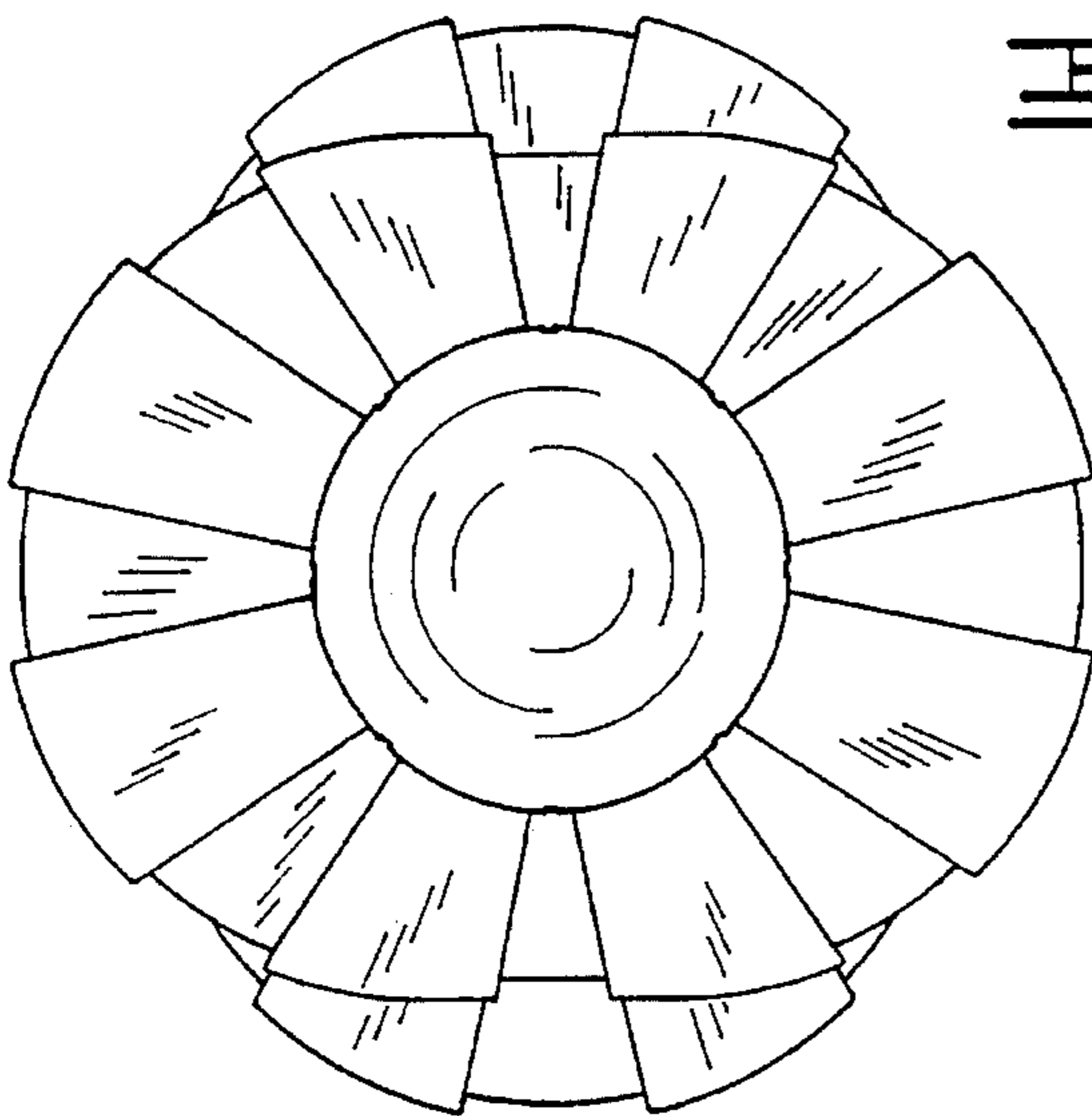

FIG. 25

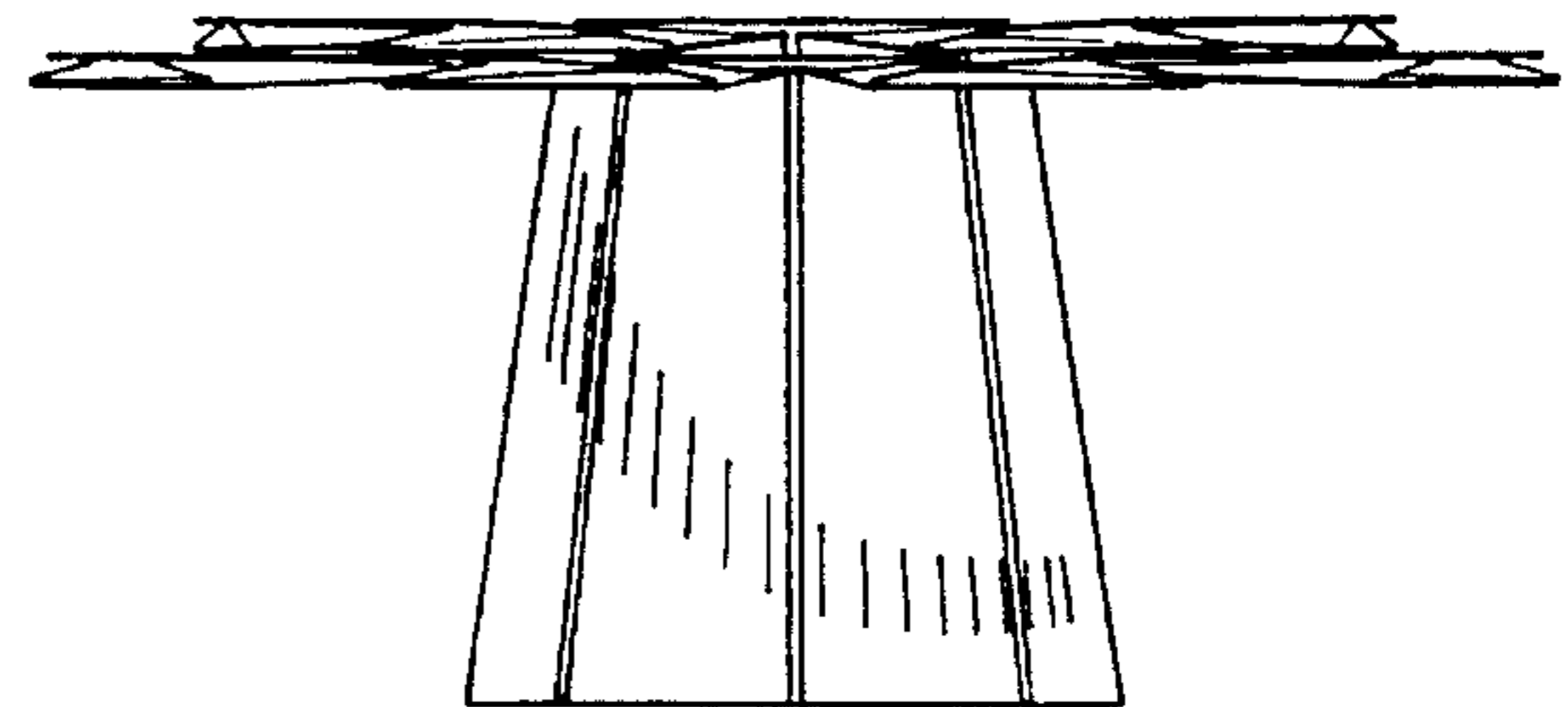

FIG. 26

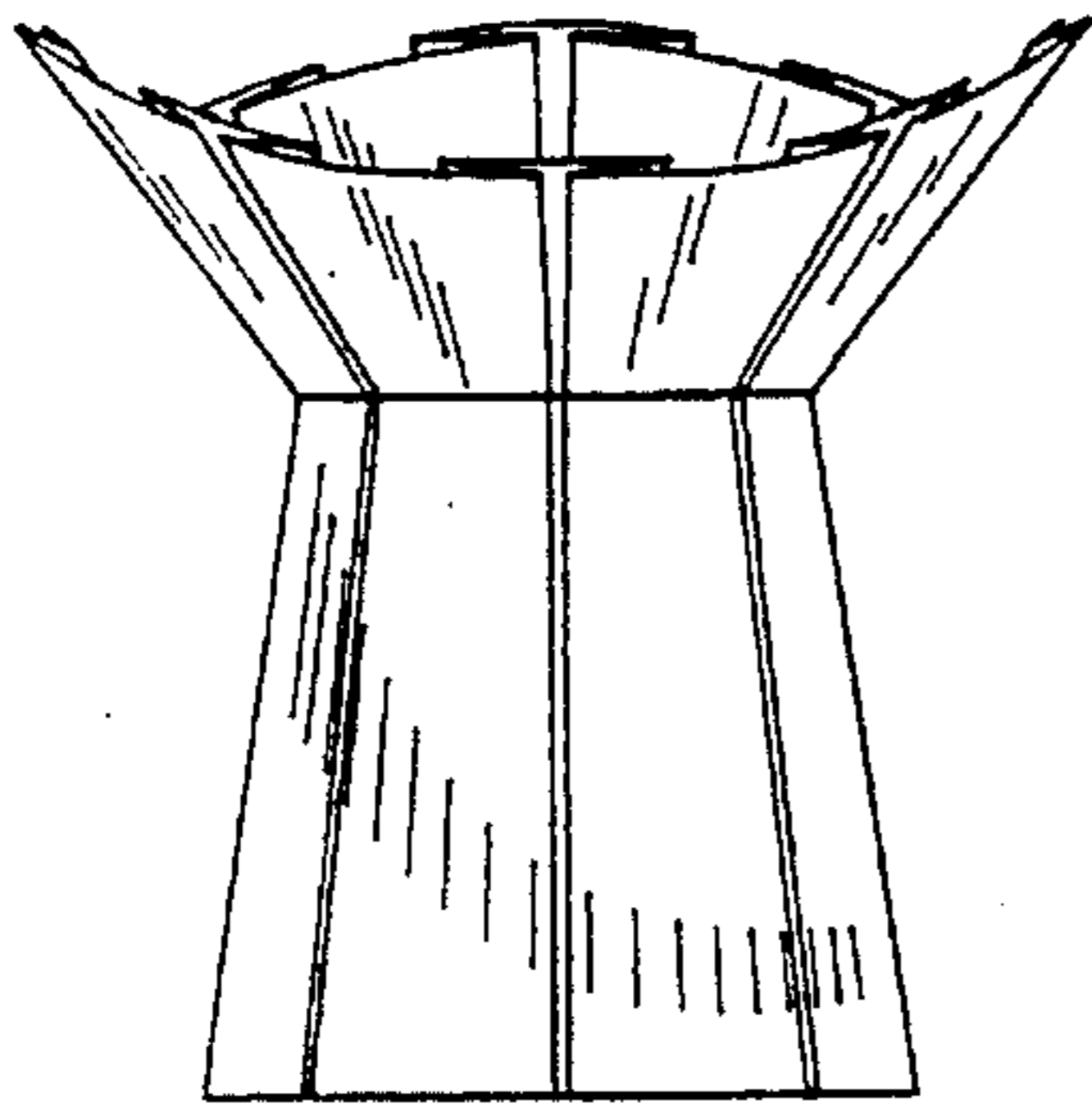

FIG. 27

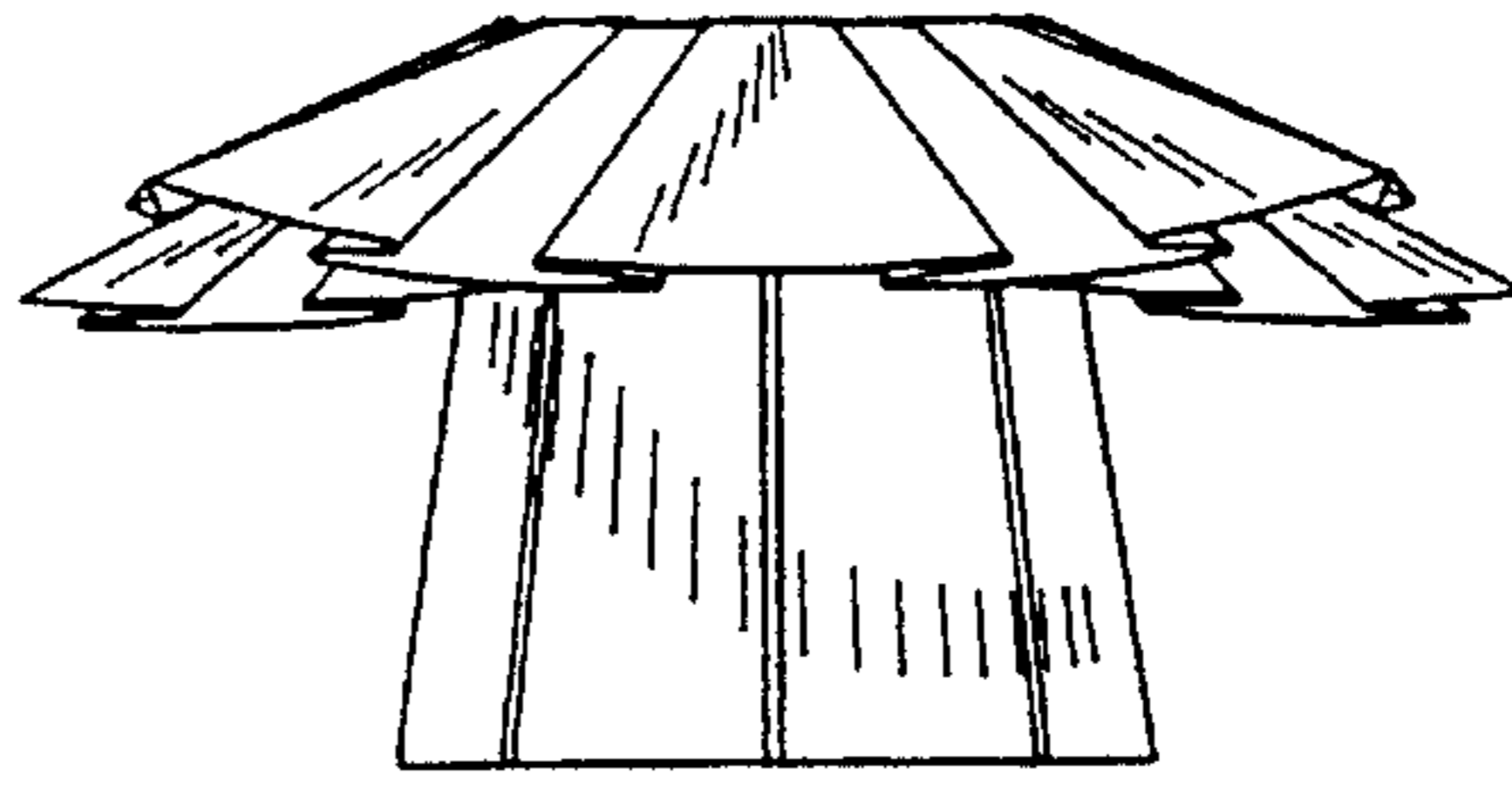

FIG. 28

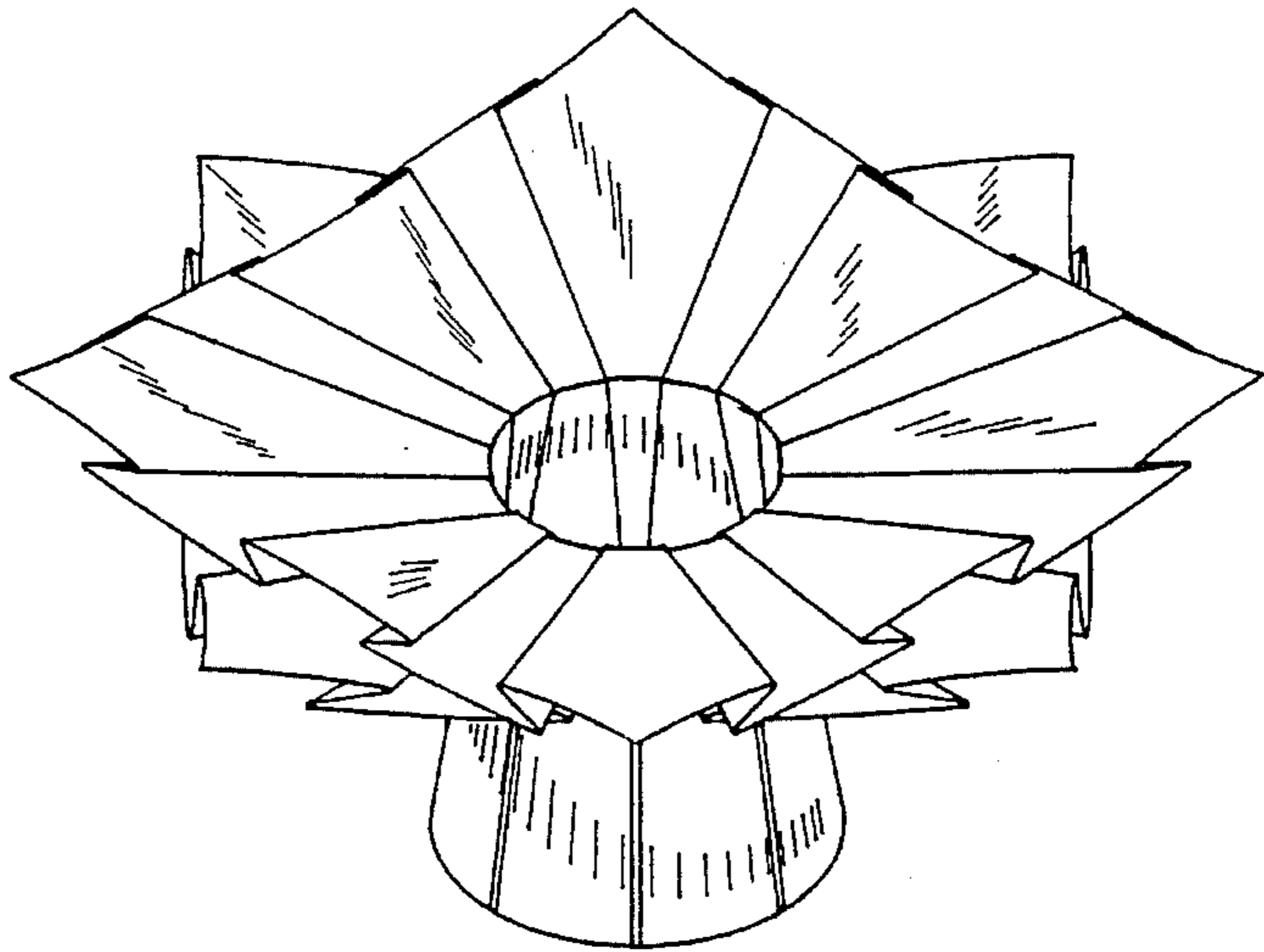

FIG. 29

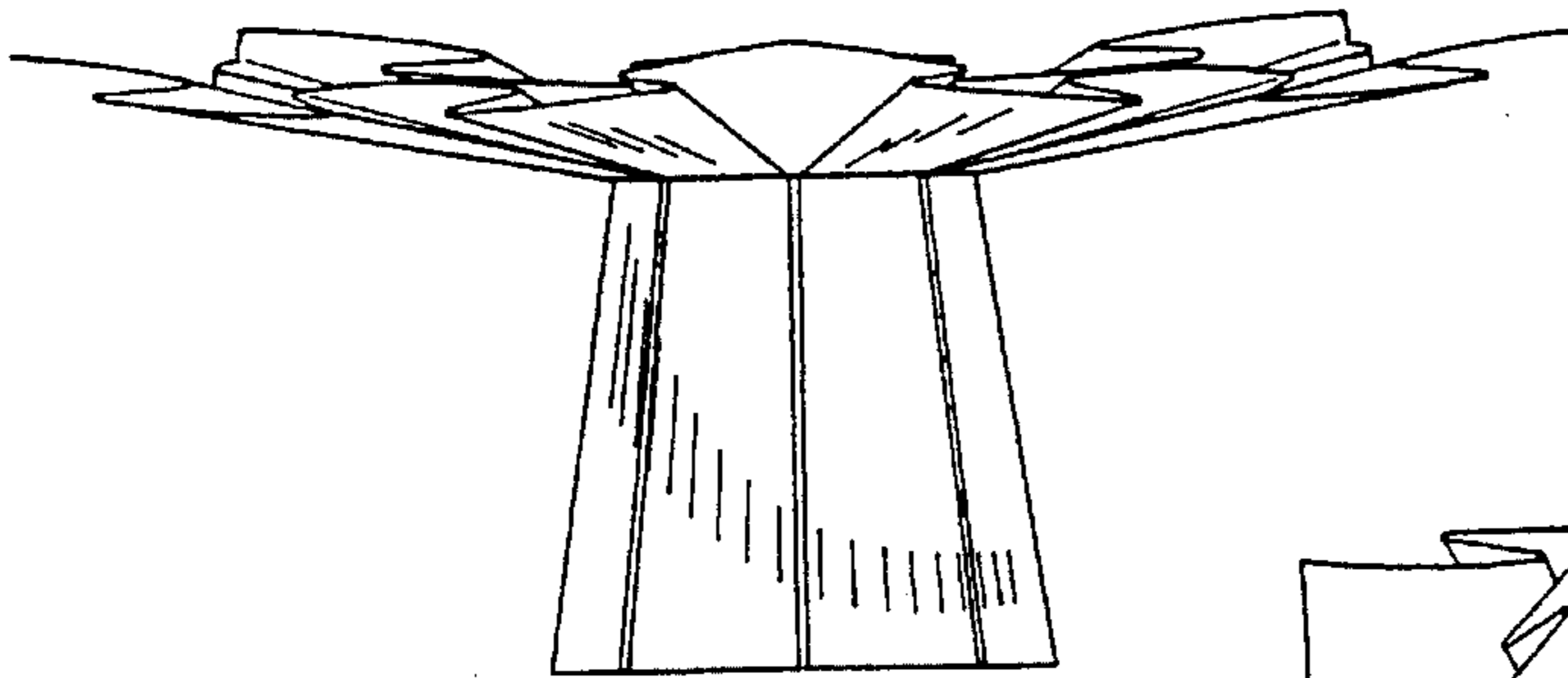

FIG. 30

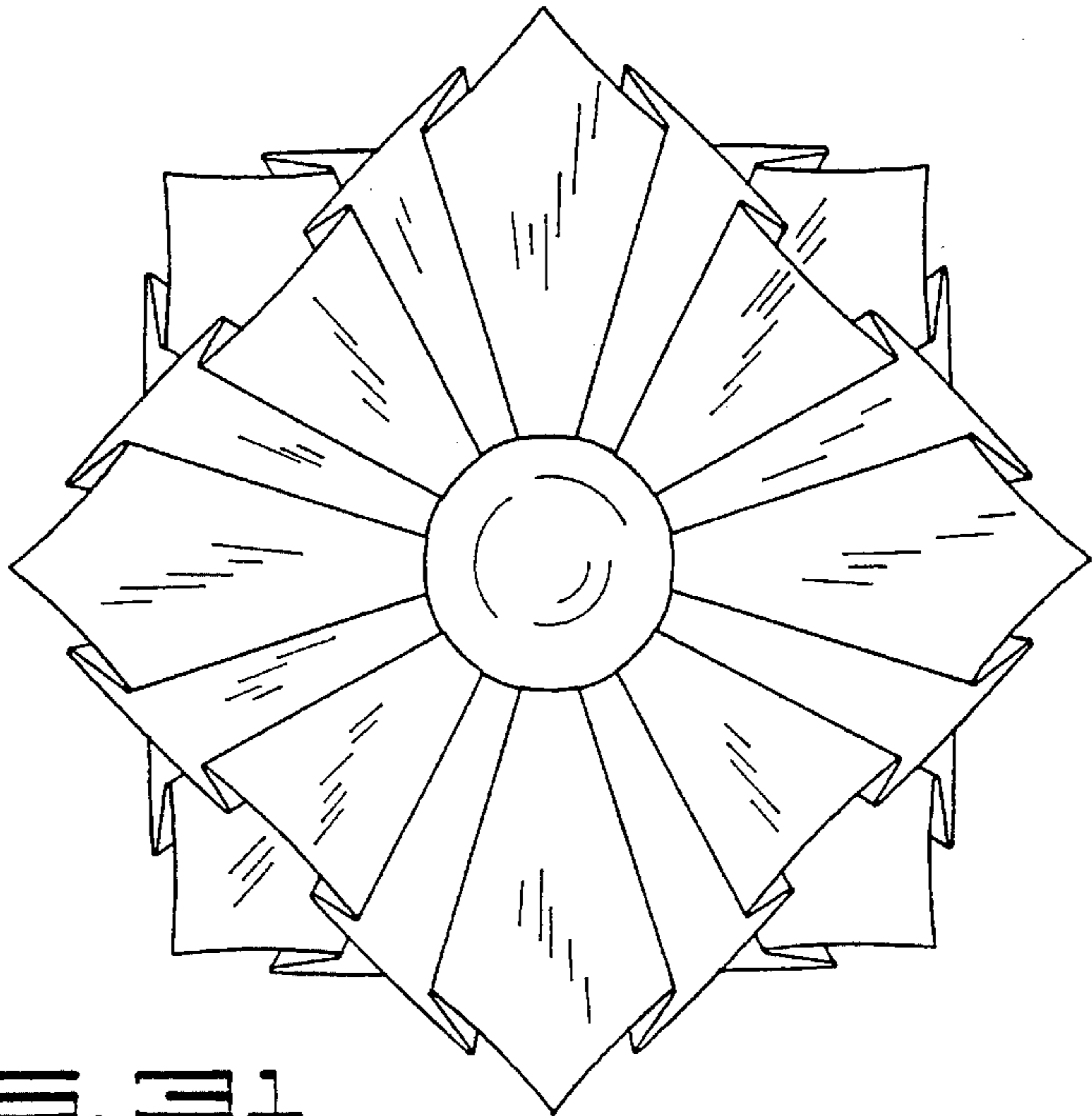

FIG. 31



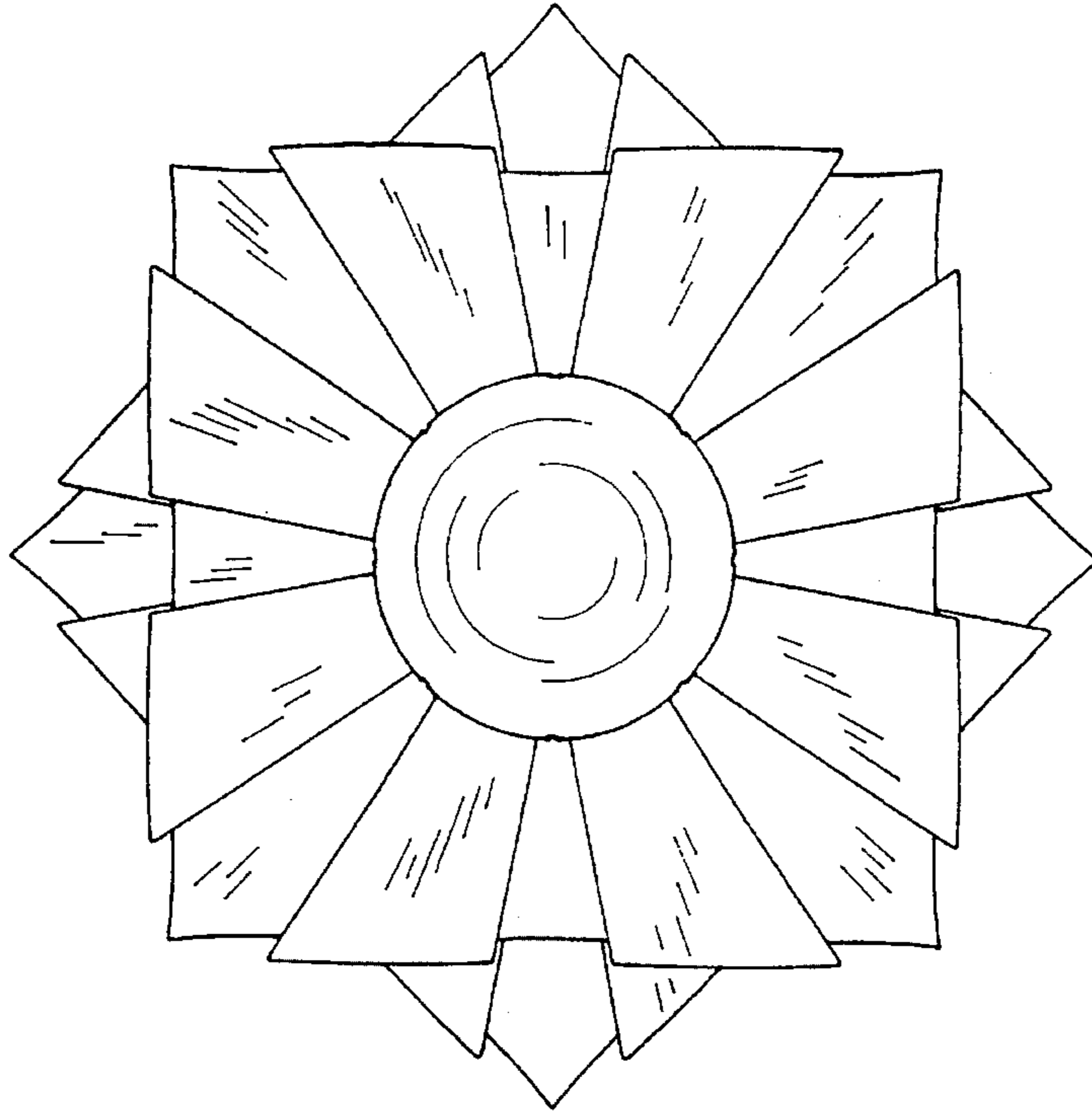

FIG. 32

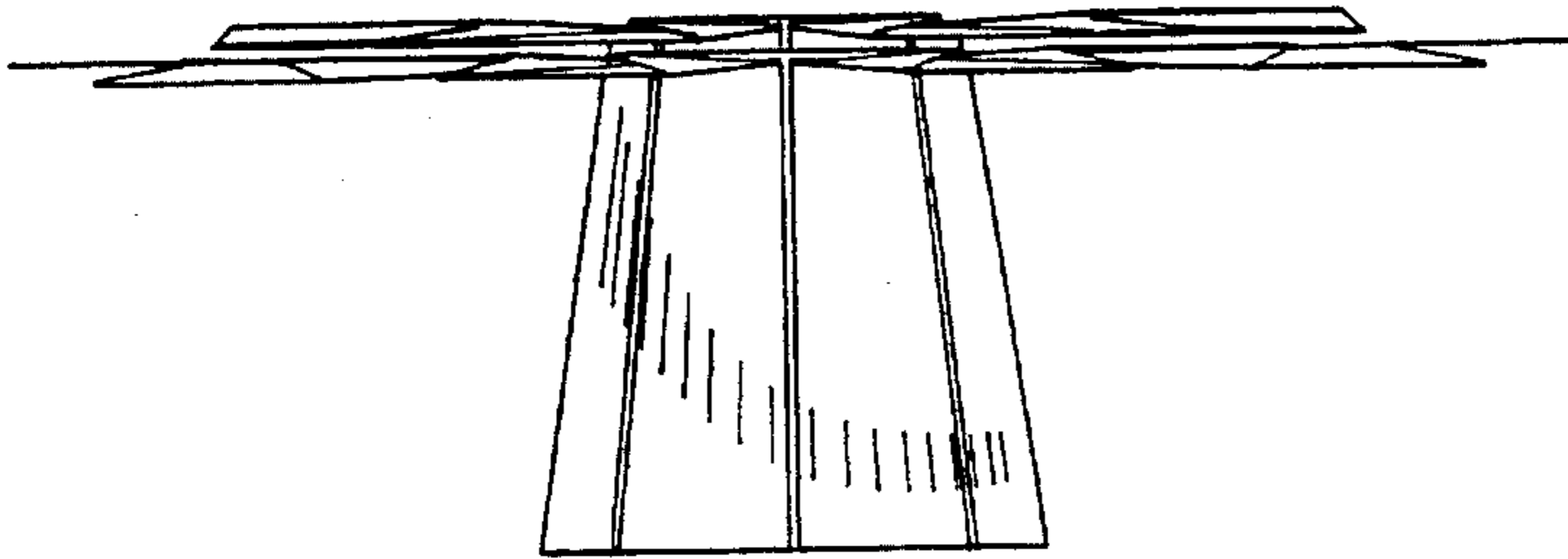

FIG. 33

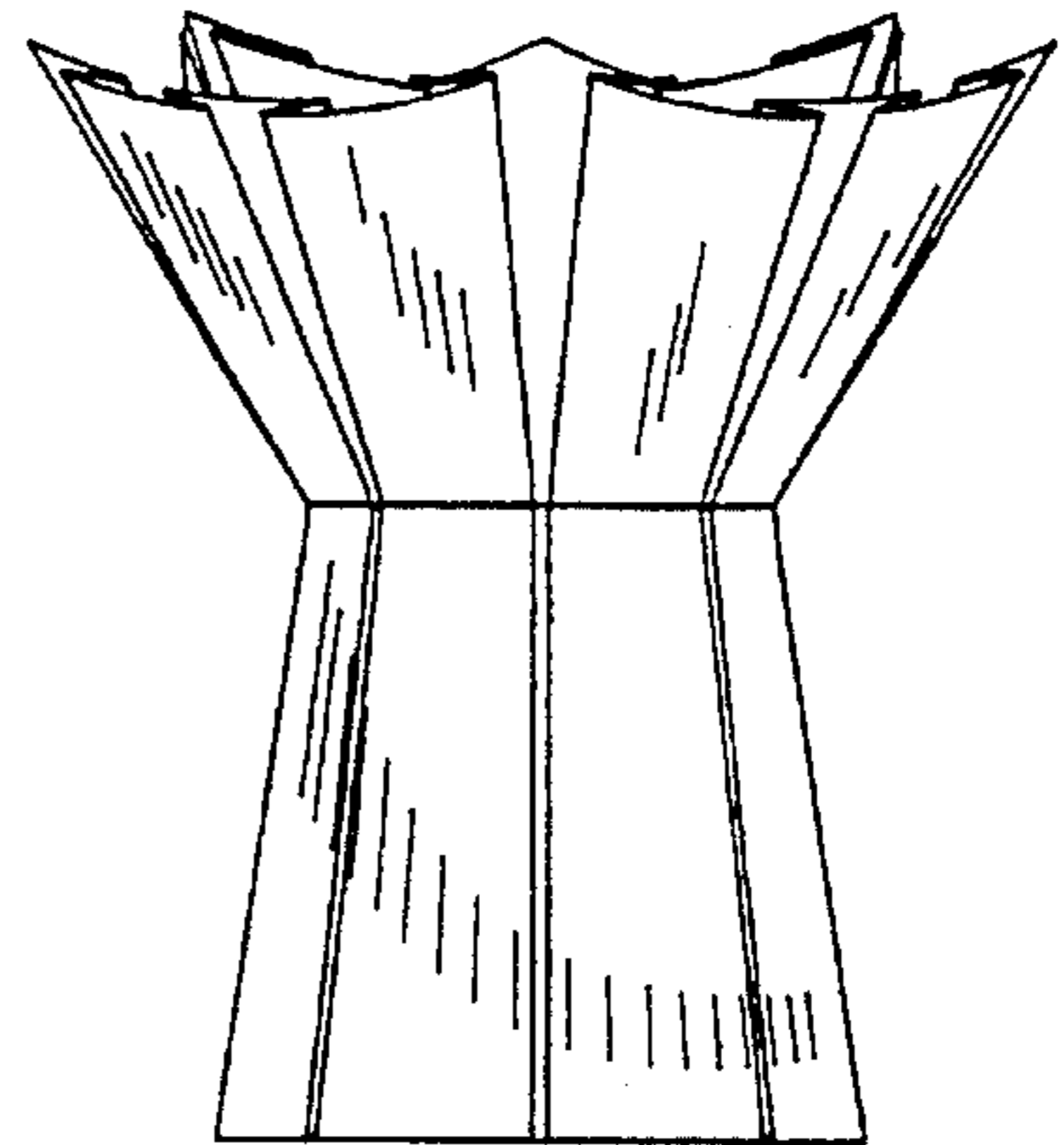

FIG. 34

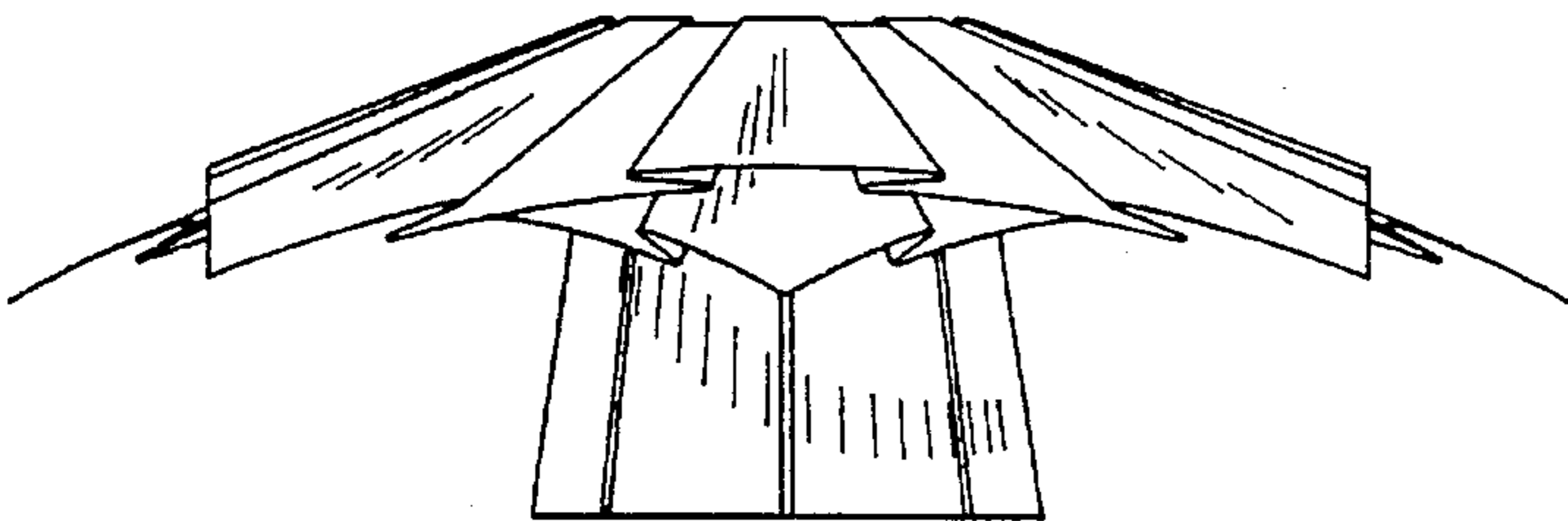

FIG. 35