



US00D368790S

United States Patent [19]
Sternberg

[11] **Patent Number: Des. 368,790**
[45] **Date of Patent: **Apr. 9, 1996**

[54] **TOY BANK**

*Building and Renovation 1994 Catalog File, section C566
15440/AQW, p. 2.*

[75] Inventor: **Harry W. Sternberg**, Huntingdon
Valley, Pa.

*Primary Examiner—Alan P. Douglas
Assistant Examiner—Robert M. Spear
Attorney, Agent, or Firm—Gregory J. Gore*

[73] Assignee: **Fun-Damental Too Ltd.**, Huntingdon
Valley, Pa.

[**] Term: **14 Years**

[57] **CLAIM**

[21] Appl. No.: **38,141**

The ornamental design for a toy bank, as shown and
described.

[22] Filed: **Apr. 27, 1995**

[52] U.S. Cl. **D99/37**

[58] Field of Search D99/35, 37; D21/121;
D23/295, 299, 301; 52/34; 446/472, 479

DESCRIPTION

[56] **References Cited**

U.S. PATENT DOCUMENTS

- D. 101,534 10/1936 Karstadt D23/301
- D. 352,576 11/1994 Trigoboff et al. D23/295

- FIG. 1 is a front elevational view of a toy bank showing my
new design;
- FIG. 2 is a top plan view;
- FIG. 3 is a left side elevational view;
- FIG. 4 is a rear elevational view thereof;
- FIG. 5 is a bottom plan view; and,
- FIG. 6 is a right side elevational view thereof.

OTHER PUBLICATIONS

- Toilet Bank, catalog #WB5, C. M. Paula Novelty Banks
Catalog, ©1975, p. 2.
- Cesame "Belle Epoque" series toilet, *Sweet's General*

1 Claim, 2 Drawing Sheets

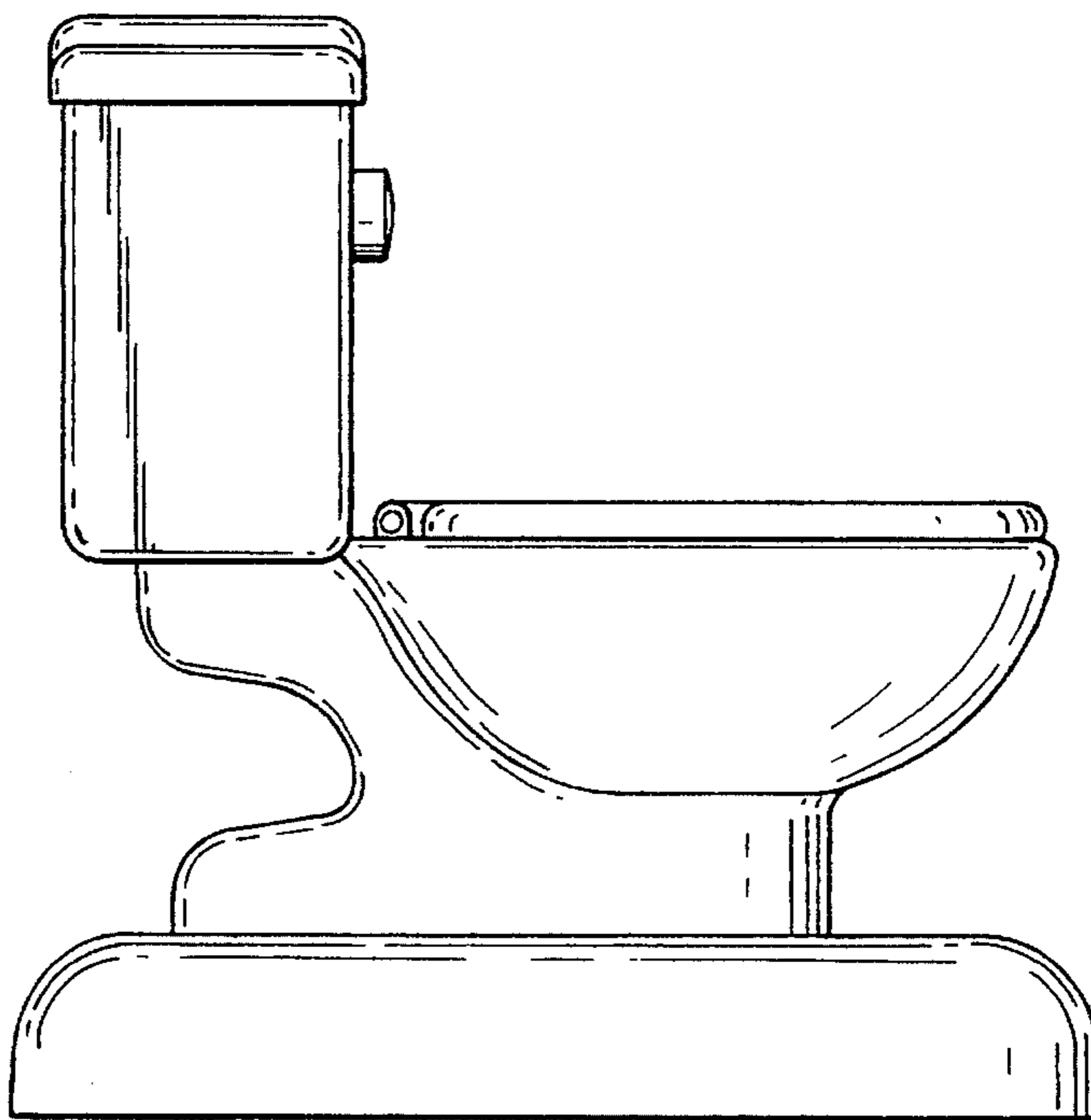
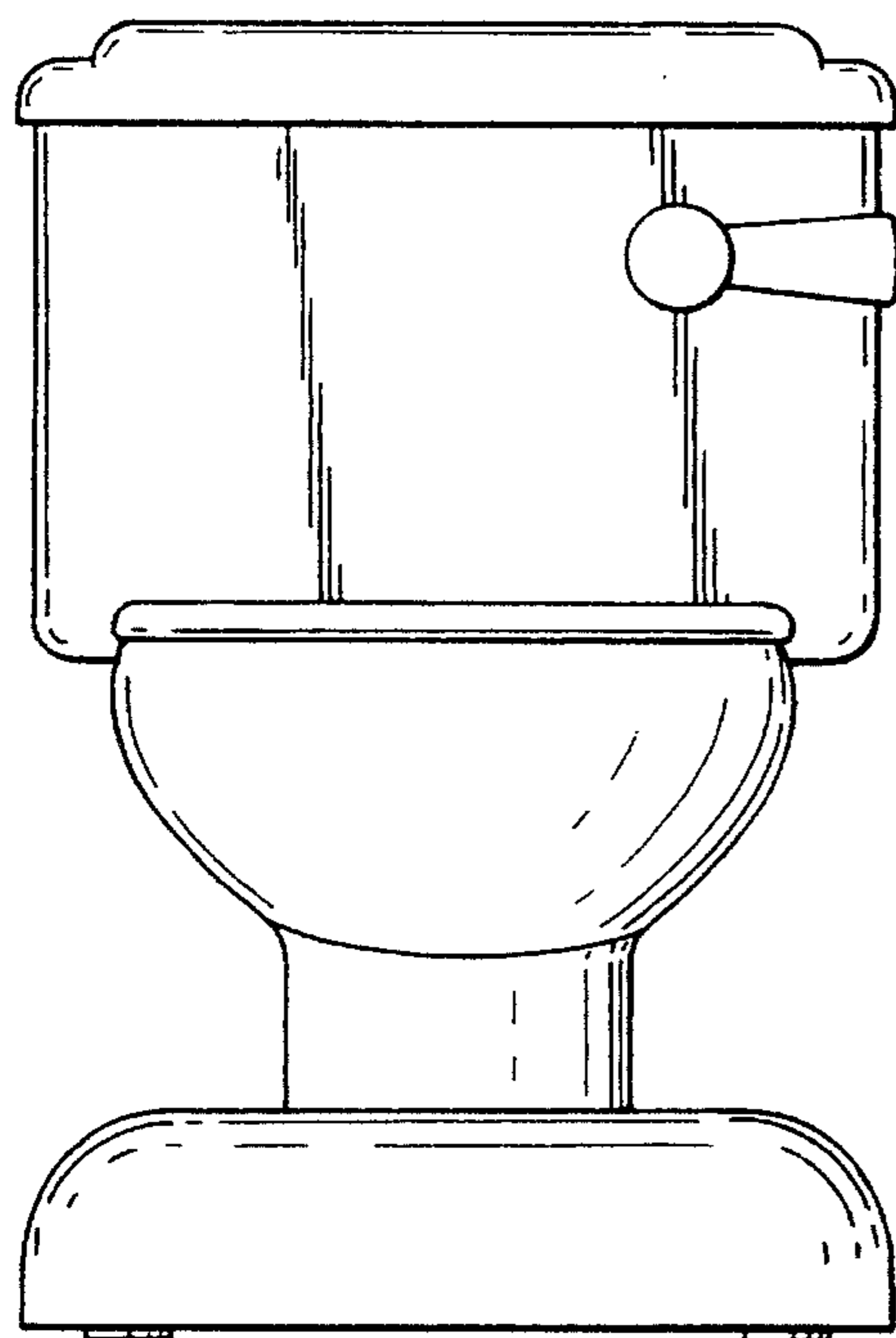

FIG. 1

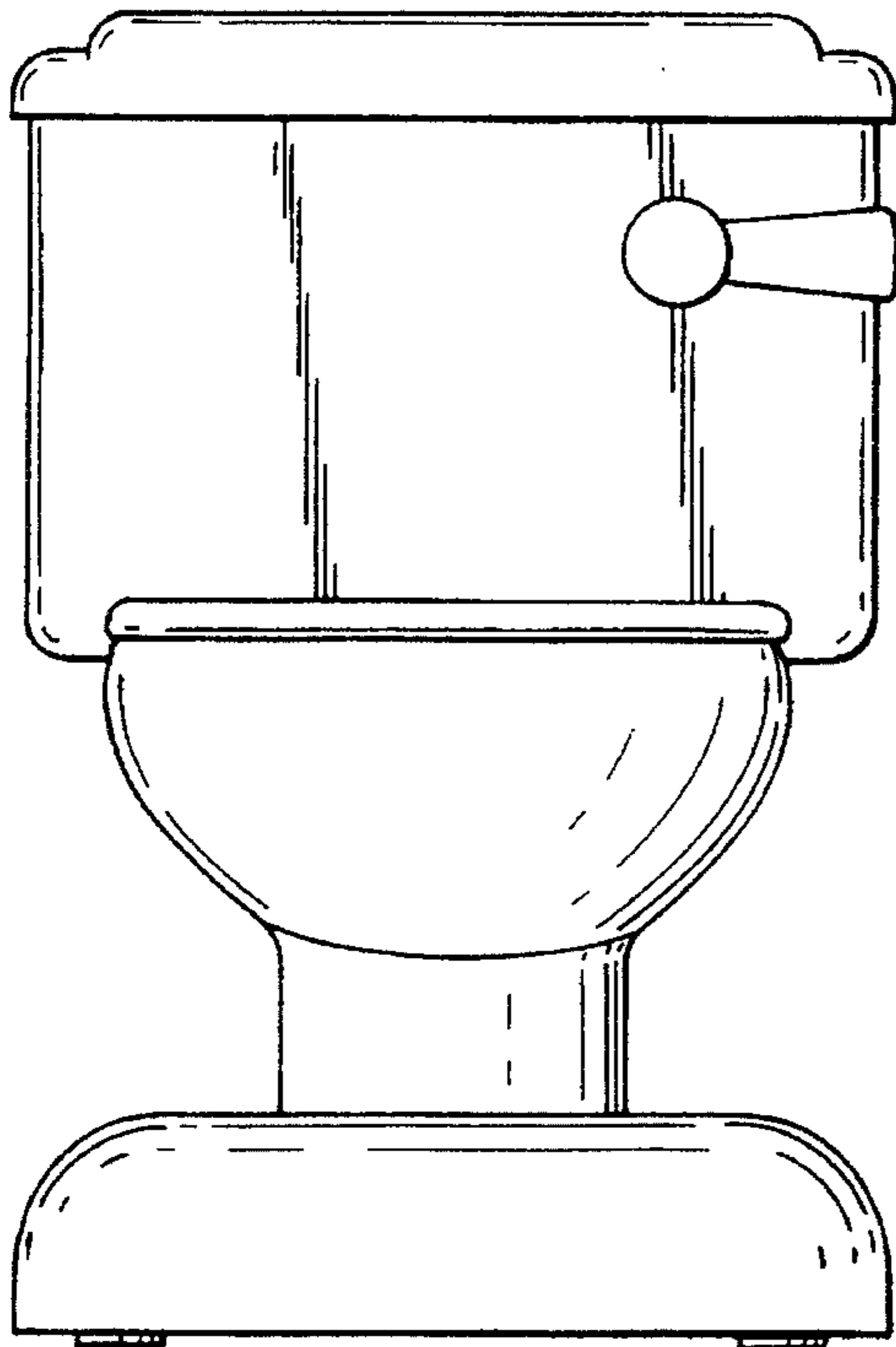

FIG. 2

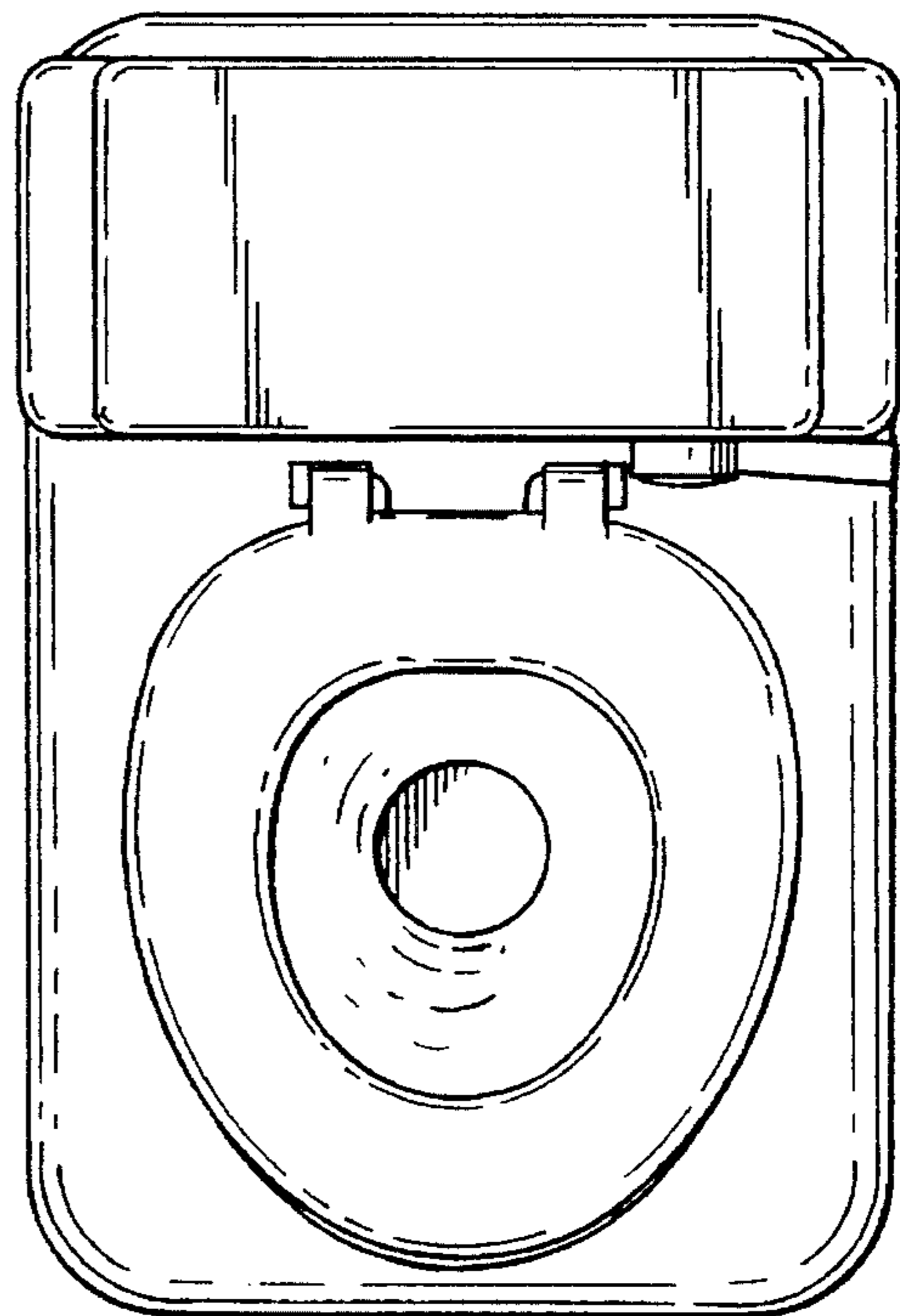

FIG. 3

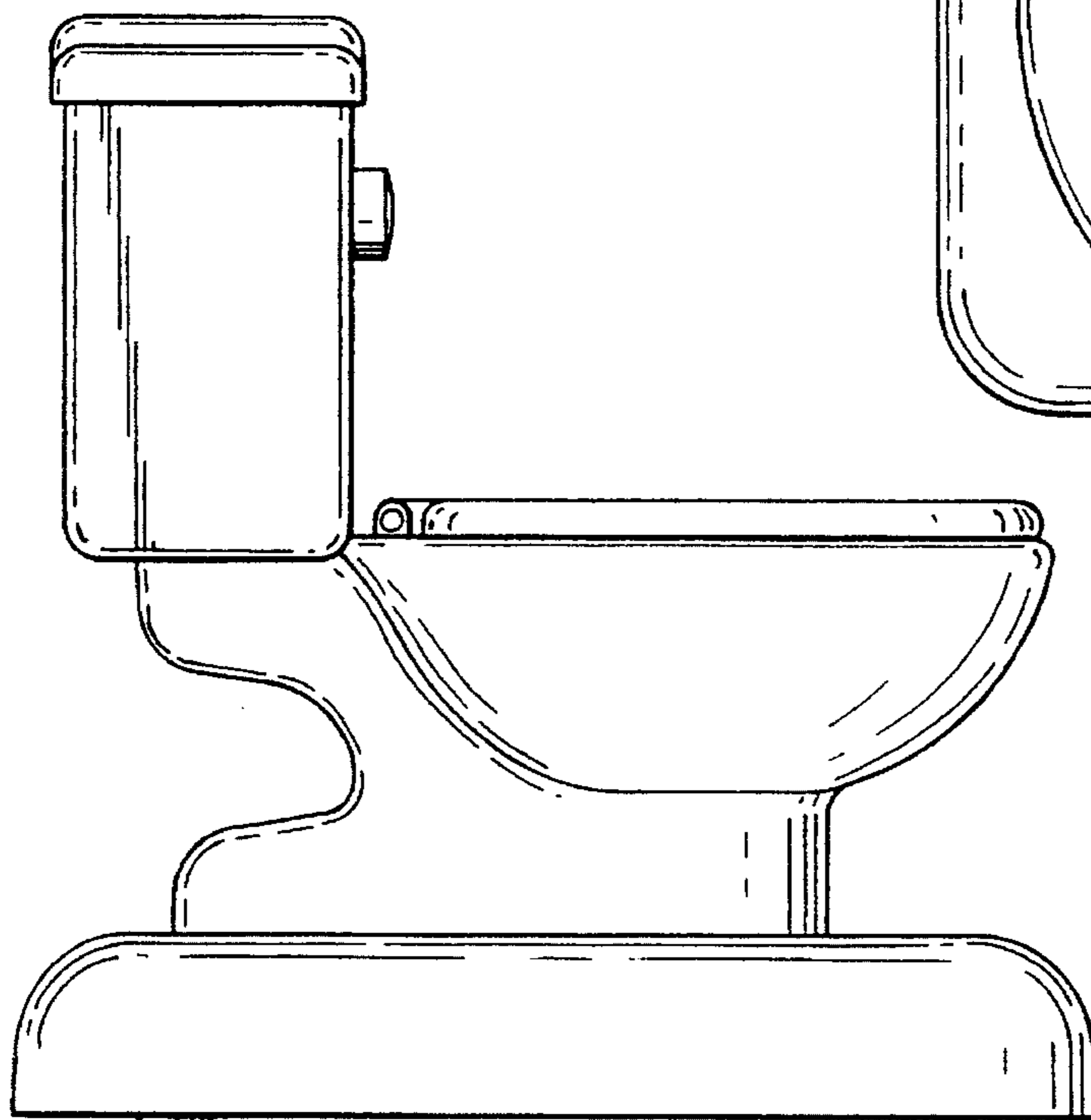

FIG. 4

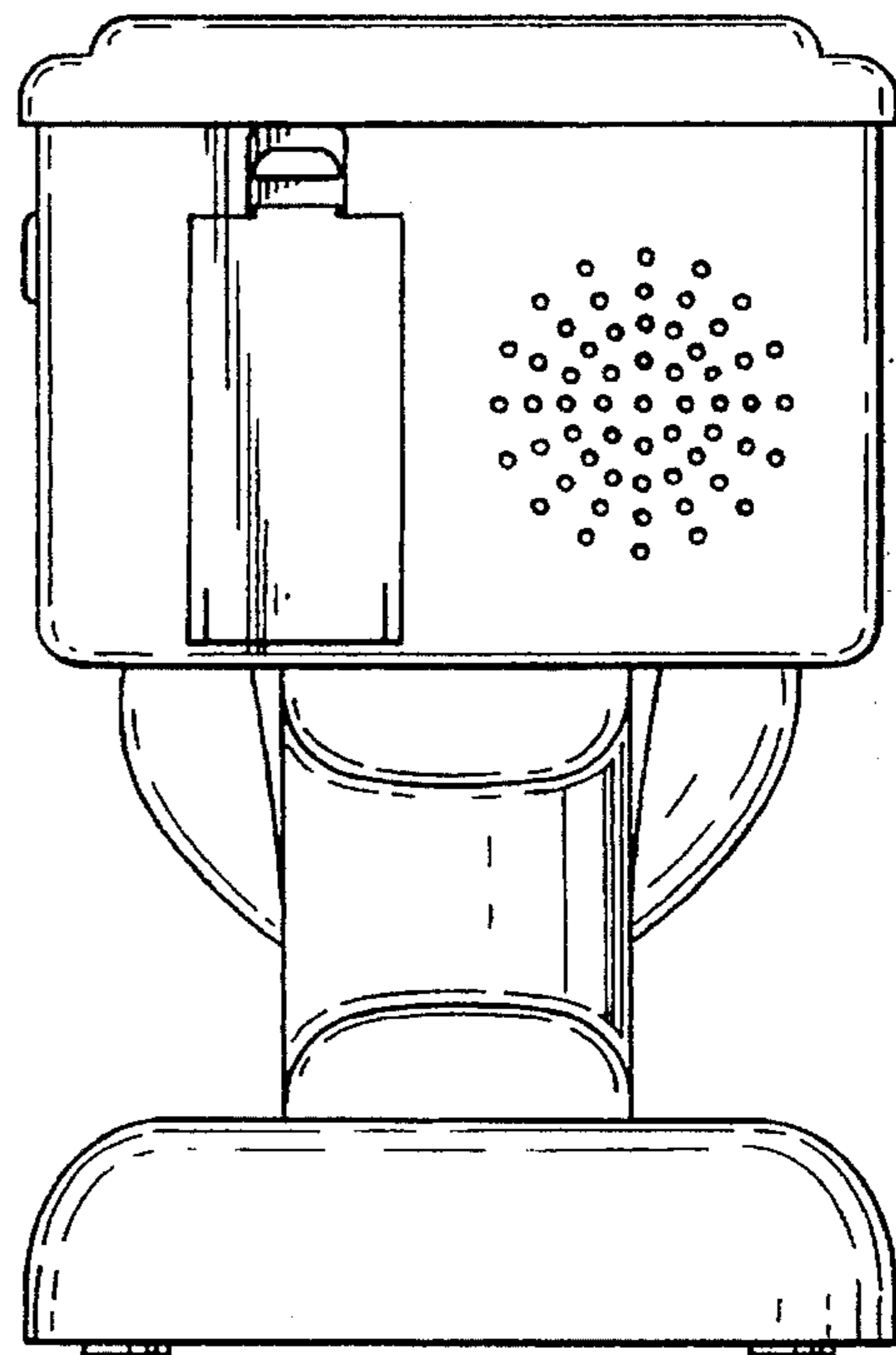

FIG. 5

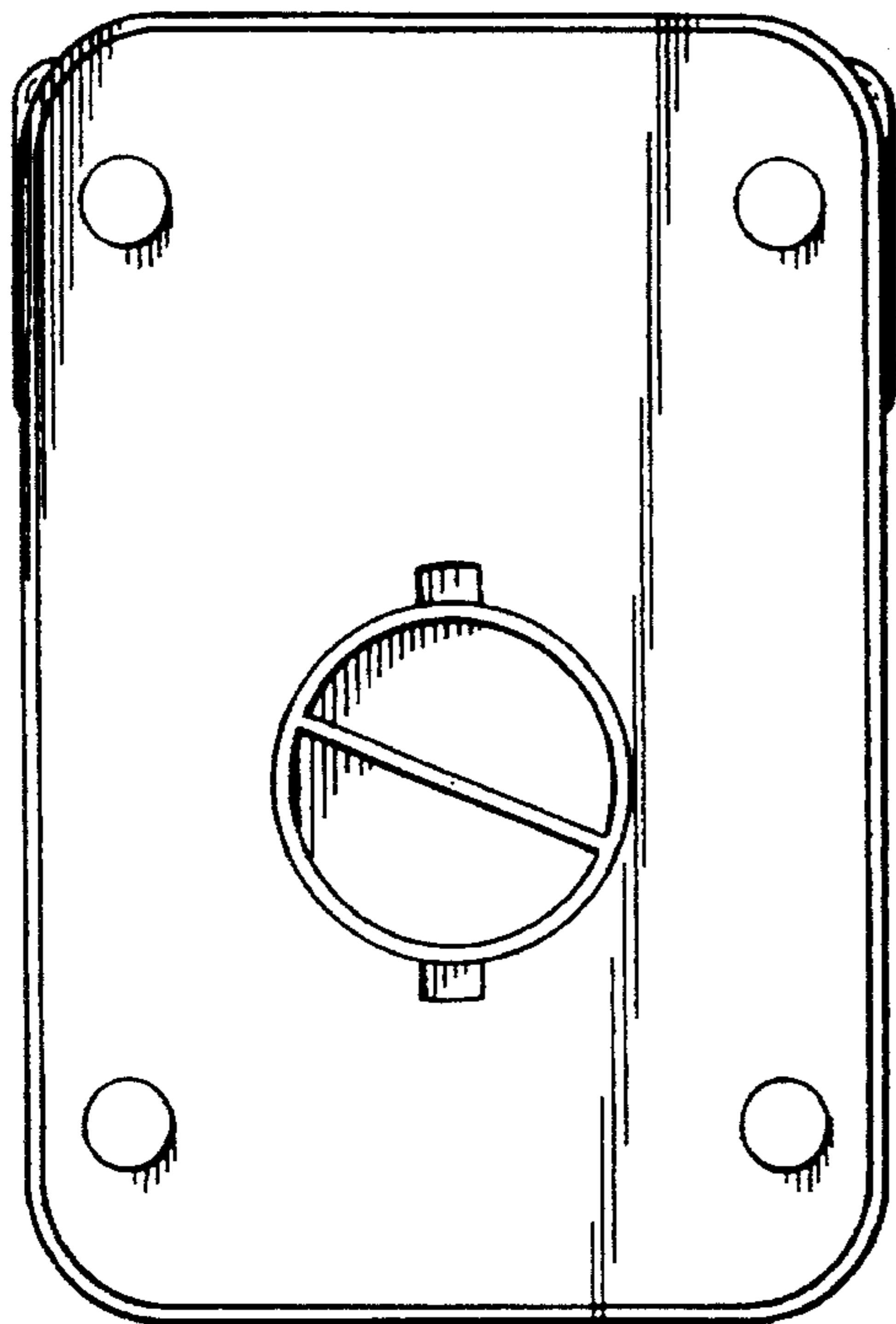

FIG. 6

