



US00D368759S

United States Patent [19] Fuligni

[11] **Patent Number:** **Des. 368,759**
[45] **Date of Patent:** ****Apr. 9, 1996**

[54] **SLIDE TOY**
[75] Inventor: **Matthew R. Fuligni**, Twinsburg, Ohio
[73] Assignee: **The Little Tikes Company**, Hudson, Ohio
[**] Term: **14 Years**
[21] Appl. No.: **34,436**
[22] Filed: **Feb. 6, 1995**
[52] **U.S. Cl.** **D21/244**
[58] **Field of Search** **D21/240-245;**
472/116, 117; 482/35-37

P. 65, Slides; Kaplan School Supply Corp., 1310 Lewisville-Clemmons Road, Lewisville, North Carolina 27023. Publication date 1986-87.
P. 18, Slides; Playscapes, address unknown. Publication date 1980.
P. 49, Slides; Mexico Forge, address unknown. Publication date 1984.
P. 25, Slide; Step 2 Corporation, 10010 Aurora-Hudson Road, P.O. Box 2412, Streetsboro, Ohio 44241-0412. Publication date 1994.
P. 80, Slide; Somby, 39170 Lavans Les St Claude, country unknown. Publication date 1994.
P. 126, Slide; Mattel, Inc., El Segundo, California 90245. Publication date 1993.
Pp. 118 and 119, Slides; Chicco, address unknown. Publication date 1991.
Pp. 40 and 41, Slides; Iron Mountain Forge, One Iron Mountain Drive, P.O. Box 897, Farmington, Missouri 63640. Publication date 1993.
Little Tikes Co.; 1991; p. 82; "Big Slide" and Play Slide.

[56] **References Cited**

U.S. PATENT DOCUMENTS

D. 202,280	9/1965	Horowitz	D34/15
D. 207,105	3/1967	Gale	D21/244
D. 250,723	1/1979	Dieter et al.	D34/5
D. 262,818	1/1982	Works	D21/243
D. 273,503	4/1984	Mariol	D21/121
D. 281,985	12/1985	Spirk et al.	D21/109
D. 294,378	2/1988	Spirk et al.	D21/244
D. 303,826	10/1989	Aker	D21/244
D. 333,328	2/1993	Aker et al.	D21/114
D. 334,610	4/1993	Aker	D21/244
D. 340,099	10/1993	Warren et al.	D21/243
D. 343,438	1/1994	Fish	D21/244
D. 344,773	3/1994	Aker et al.	D21/244
DF. 347,458	5/1994	Cunard et al.	D21/243
D. 355,692	2/1995	Houry et al.	D21/244
D. 355,693	2/1995	Aker et al.	D21/244
D. 357,300	4/1995	Maynard	D21/244
5,407,393	5/1995	Schmidt	472/117

OTHER PUBLICATIONS

P. 95, Slide; "Popular Science", address unknown. Publication date Jan., 1989.
Catalog page, Slides, The Children's Factory, 505 North Kirkwood Road, St. Louis, Missouri 63122. Publication date 1986-88.

Primary Examiner—Ted Shooman
Assistant Examiner—Mitchell I. Siegel
Attorney, Agent, or Firm—Richard B. O'Planick; Lisa B. Riedesel

[57] **CLAIM**

The ornamental design for a slide toy, as shown and described.

DESCRIPTION

FIG. 1 is a top right front perspective view of a slide toy showing my new design;
FIG. 2 is a right side elevational view thereof; the left side elevational view being a mirror image;
FIG. 3 is a front elevational view thereof;
FIG. 4 is a rear elevational view thereof;
FIG. 5 is a top plan view thereof; and,
FIG. 6 is a bottom plan view thereof.

1 Claim, 3 Drawing Sheets

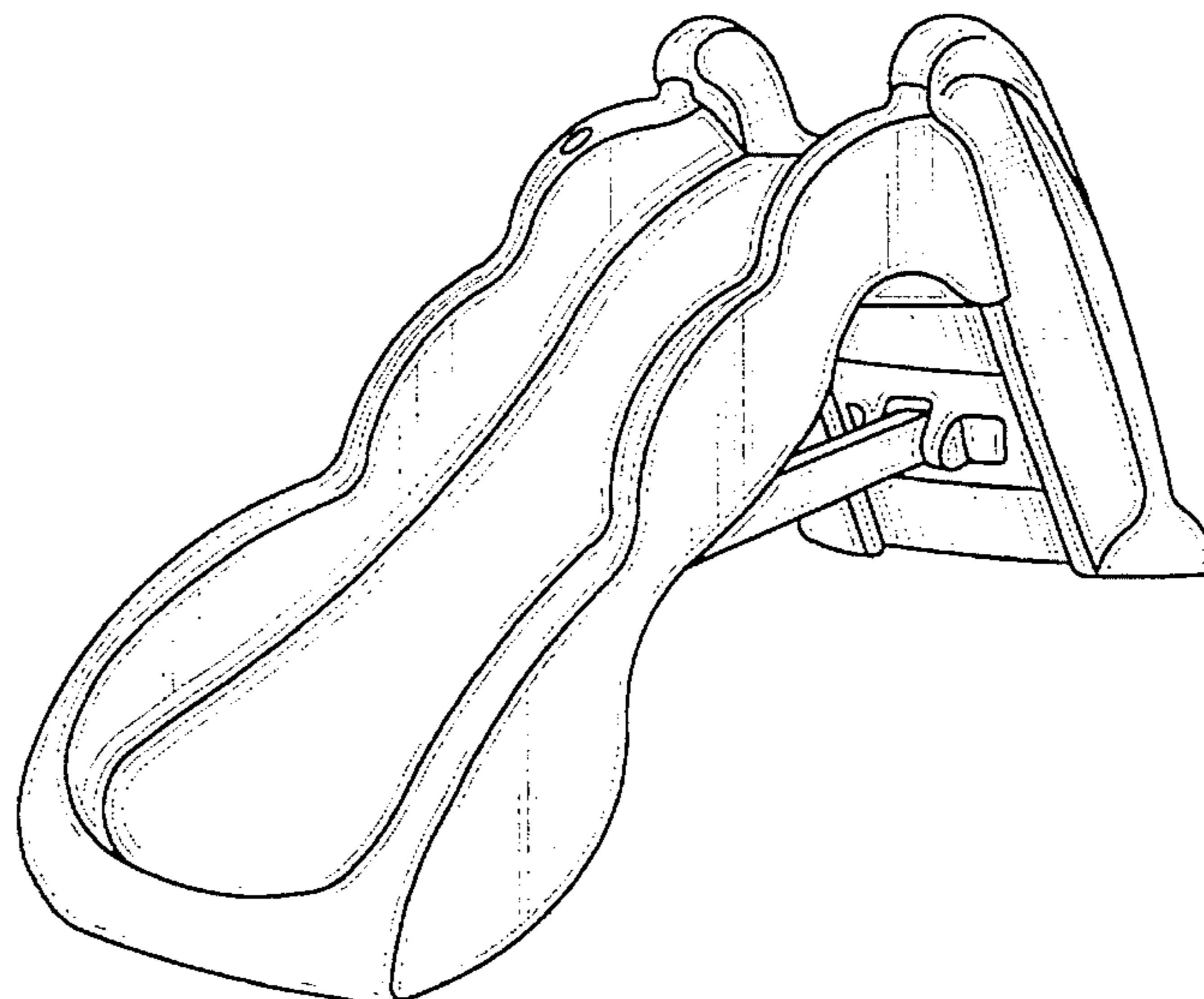

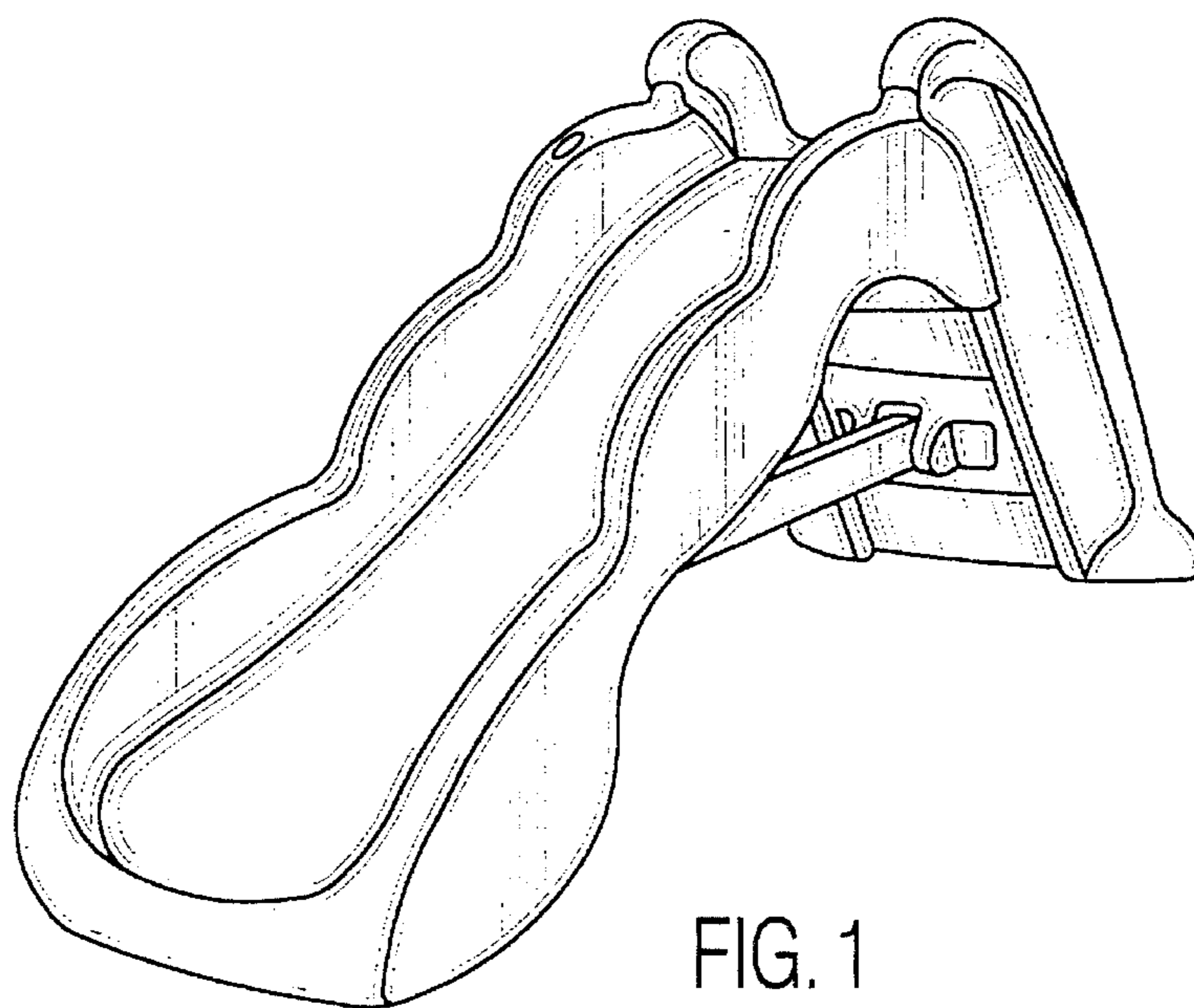

FIG. 1

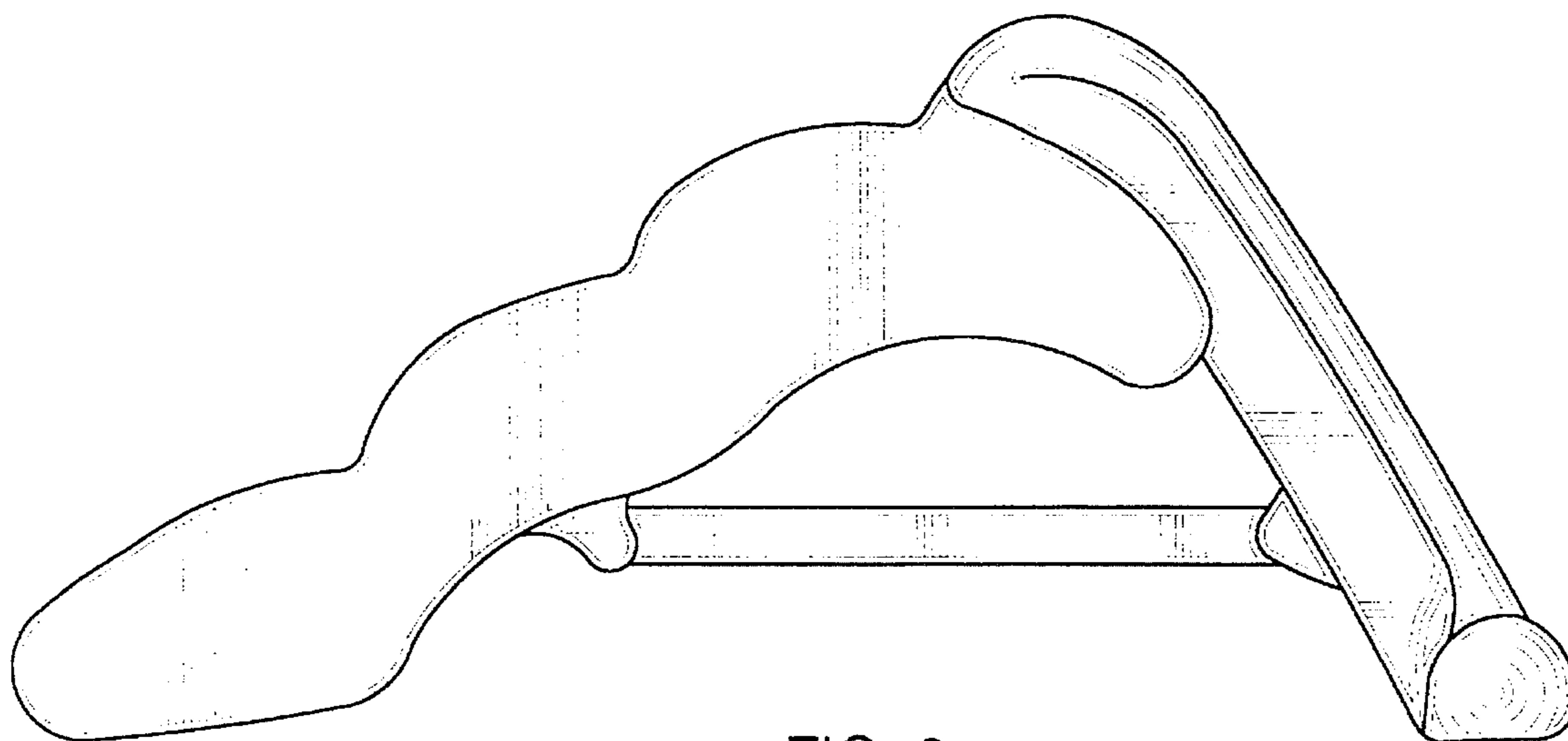

FIG. 2

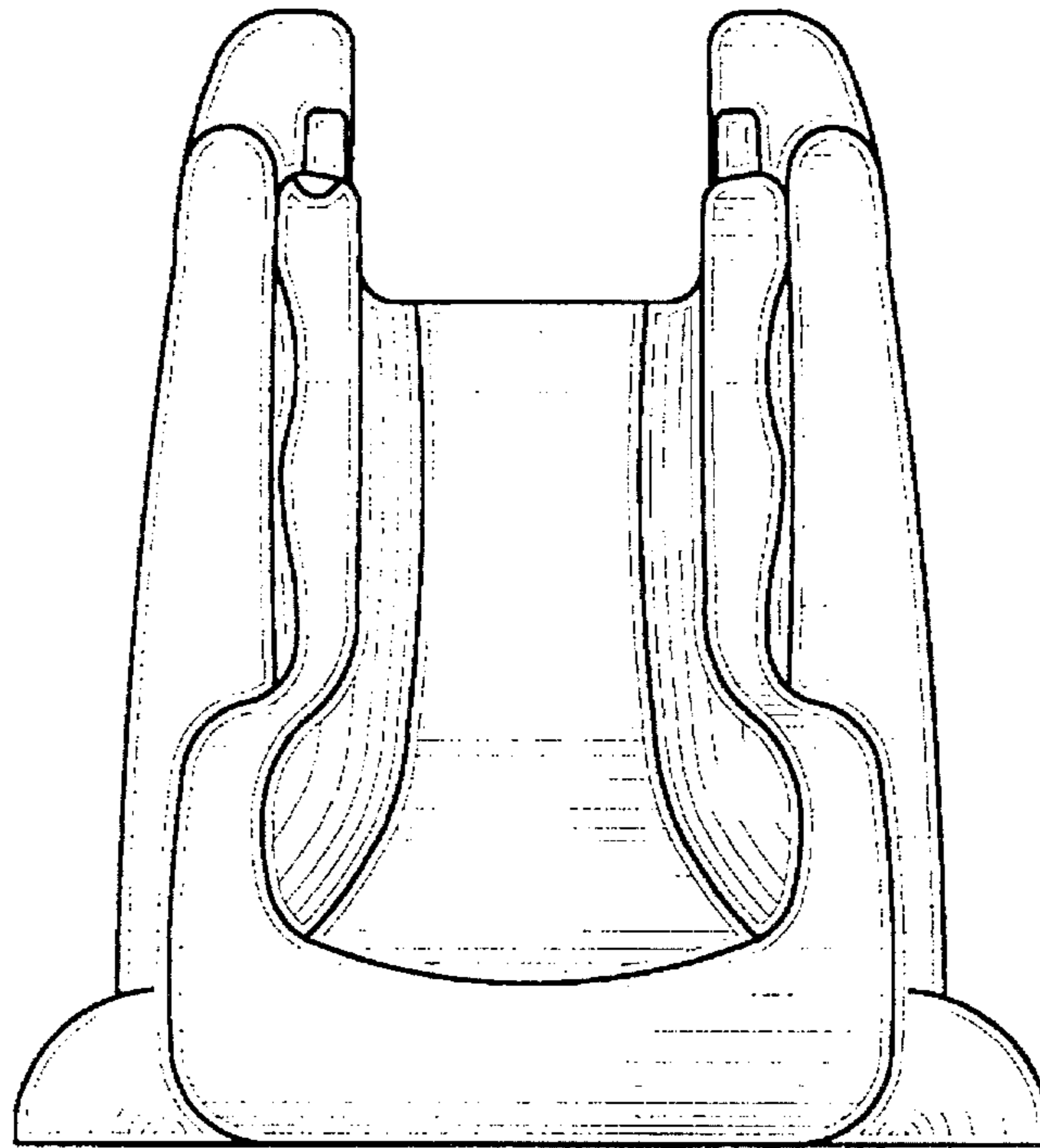

FIG. 3

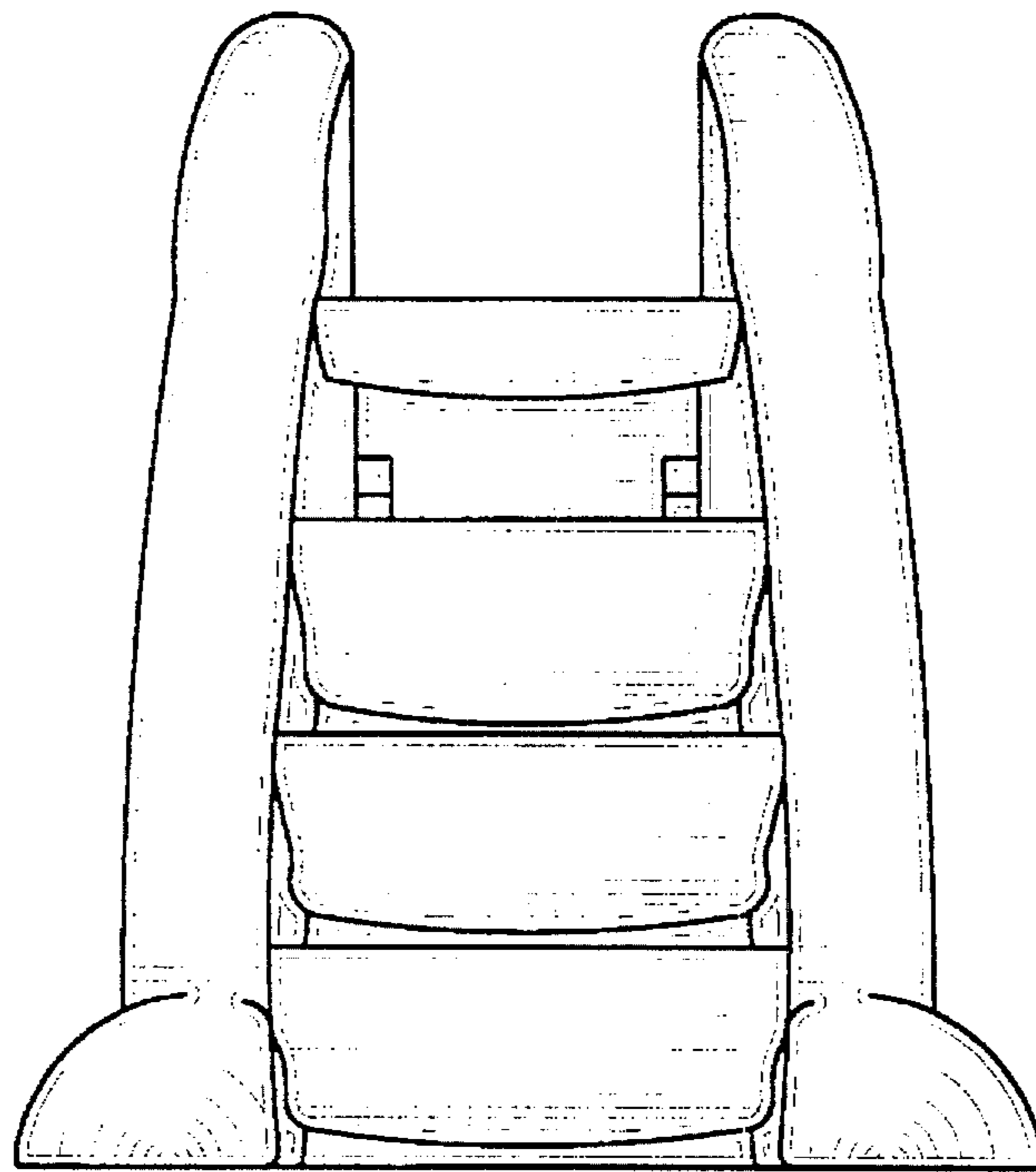

FIG. 4

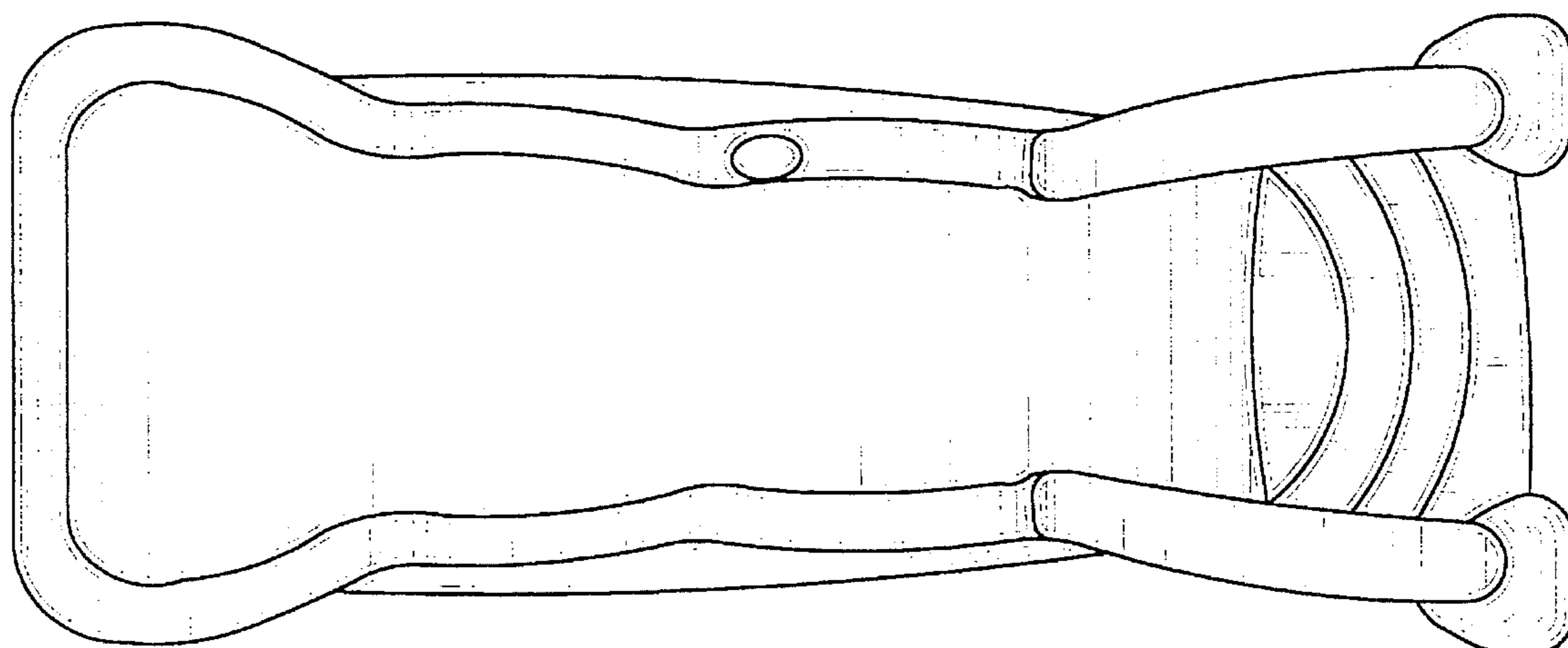

FIG. 5

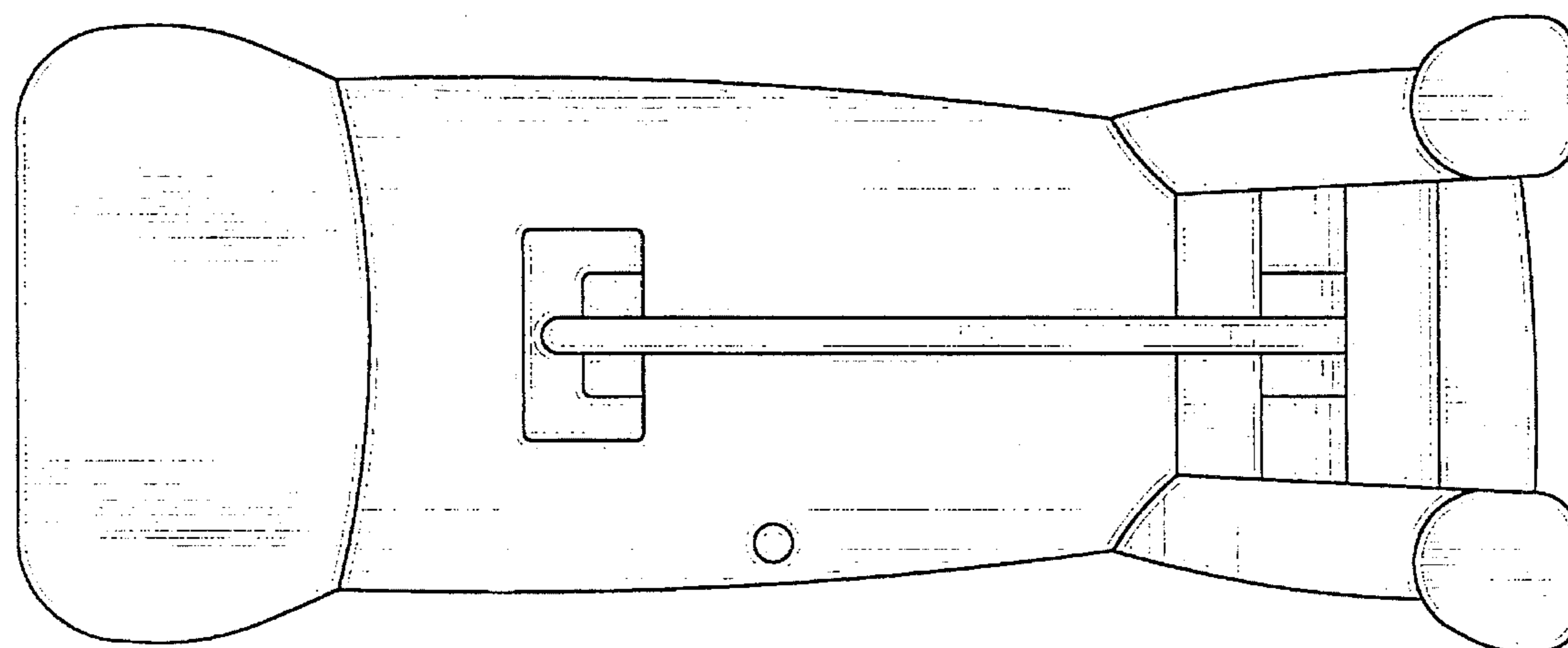

FIG. 6