



US00D368753S

United States Patent [19]

Blough et al.

[11] Patent Number: **Des. 368,753**

[45] Date of Patent: ***** Apr. 9, 1996**

[54] **GOLF CLUB HEAD**

5,048,834 9/1991 Gorman .

[75] Inventors: **R. Thomas Blough**, Mineral, Va.;
Eugene L. Sheeley, Ft. Worth, Tex.

[73] Assignee: **Ben Hogan Company**, Richmond, Va.

[*] Notice: The portion of the term of this patent subsequent to Oct. 3, 2009, has been disclaimed.

[**] Term: **14 Years**

[21] Appl. No.: **28,670**

[22] Filed: **Sep. 20, 1994**

[52] U.S. Cl. **D21/220**

[58] Field of Search D21/220; 273/167-175

[56] **References Cited**

U.S. PATENT DOCUMENTS

D. 141,307	5/1945	Newsome	D21/220
D. 141,769	7/1945	Newsome .	
D. 203,936	3/1966	Long .	
D. 300,547	4/1989	Kobayashi	D21/220
D. 329,481	9/1992	Hunt .	
D. 332,984	2/1993	Iinuma .	
D. 337,143	7/1993	Lo	D21/220
2,254,528	9/1941	Hoate .	

OTHER PUBLICATIONS

Golf World; Aug. 28, 1987; p. 19; "Ben Hogan" Iron, bottom of page.

Northwestern 1976 Catalog; p. 22; "Lady Ultimate" Iron on left of page.

Primary Examiner—Ted Shooman

Assistant Examiner—Mitchell I. Siegel

Attorney, Agent, or Firm—Martin Smolowitz

[57] **CLAIM**

The ornamental design for a golf club head, as shown and described.

DESCRIPTION

FIG. 1 is a front elevational view of the golf club head showing our new design; FIG. 2 is a top plan view thereof; FIG. 3 is right side view thereof; FIG. 4 is a left side view thereof; FIG. 5 is a bottom plan view thereof; FIG. 6 is a rear elevational view thereof; and, FIG. 7 is a cross-sectional view taken along lines 7/7 of FIG. 1.

1 Claim, 3 Drawing Sheets

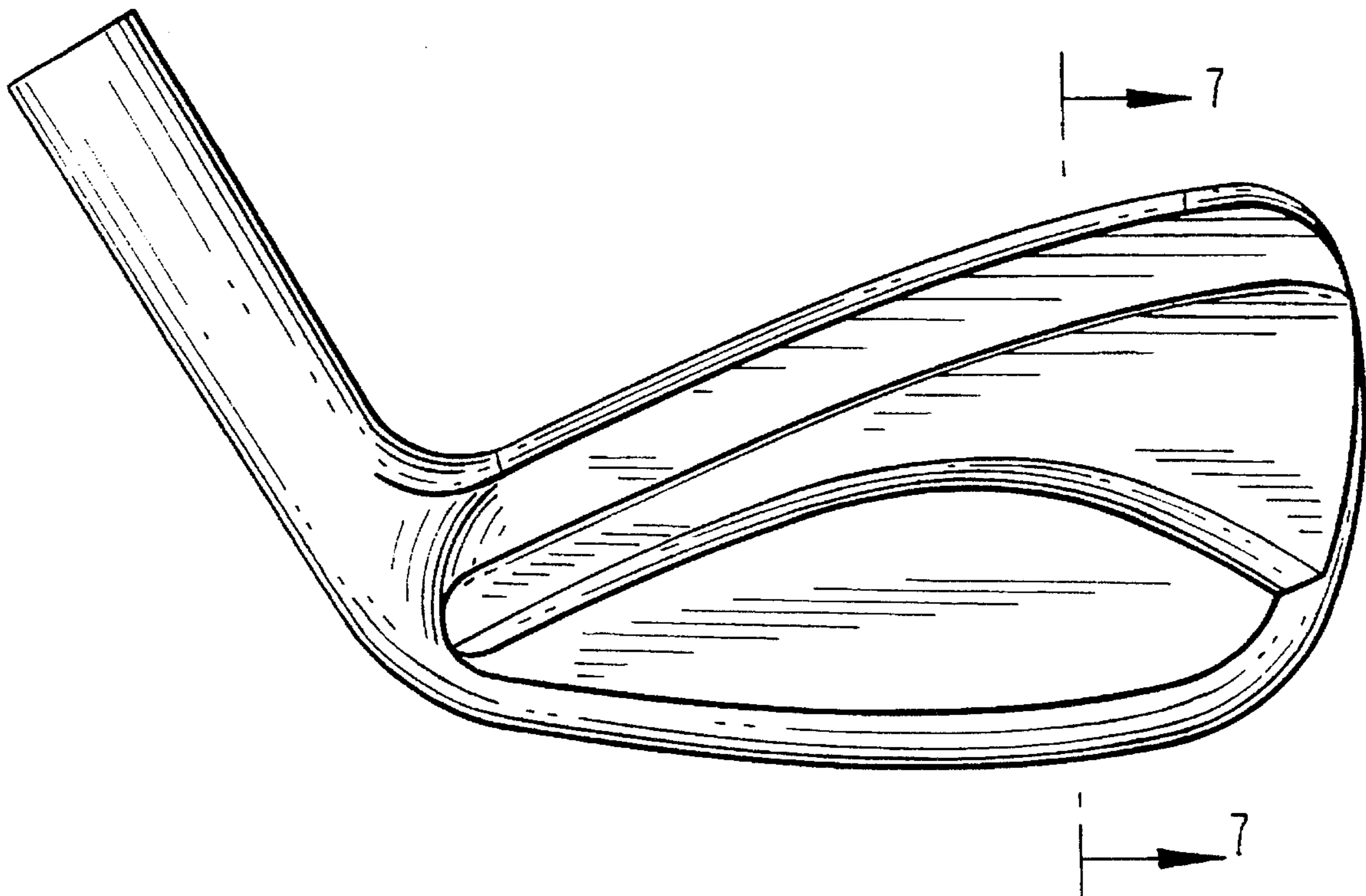

FIG. 1

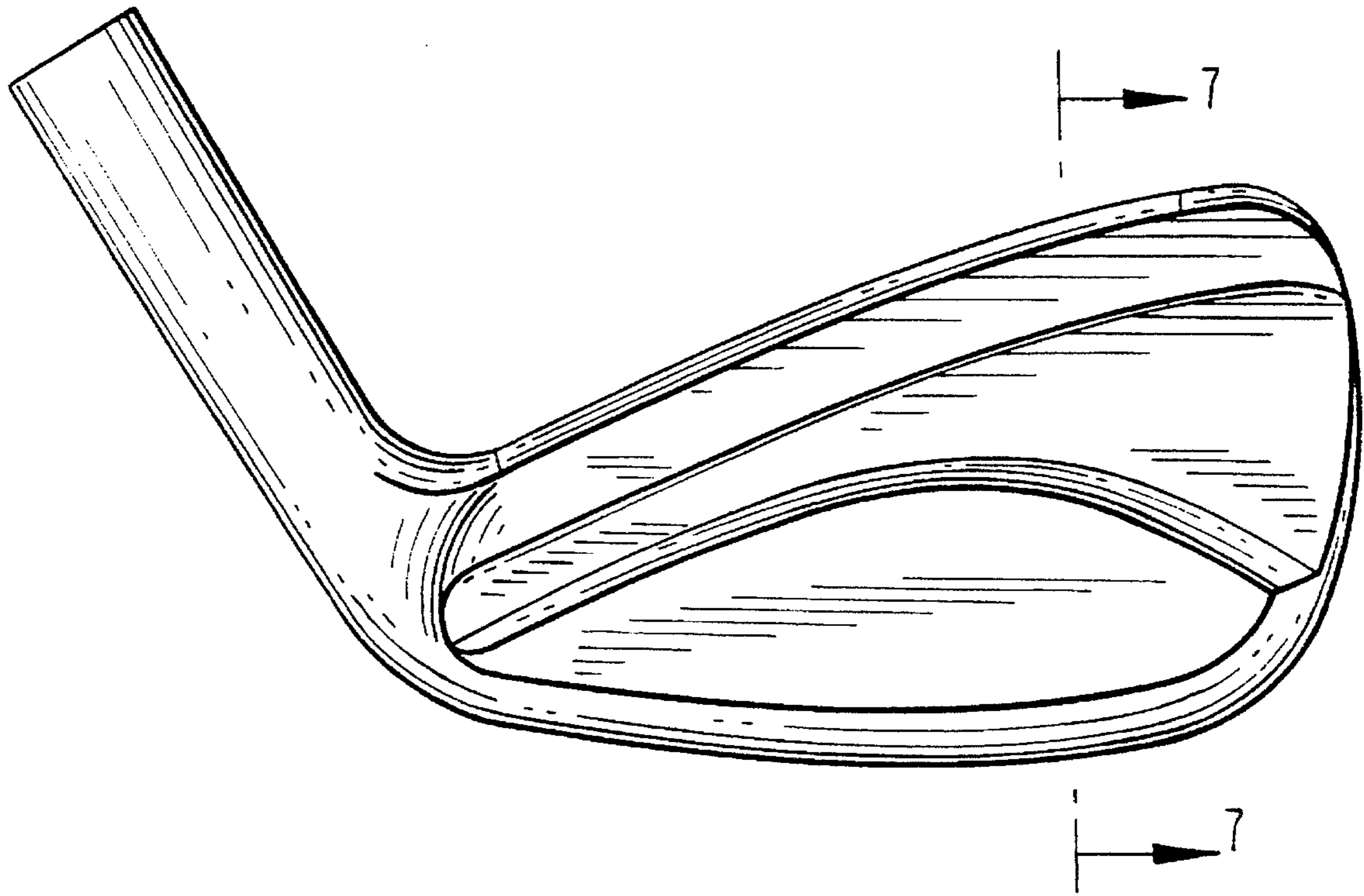

FIG. 2

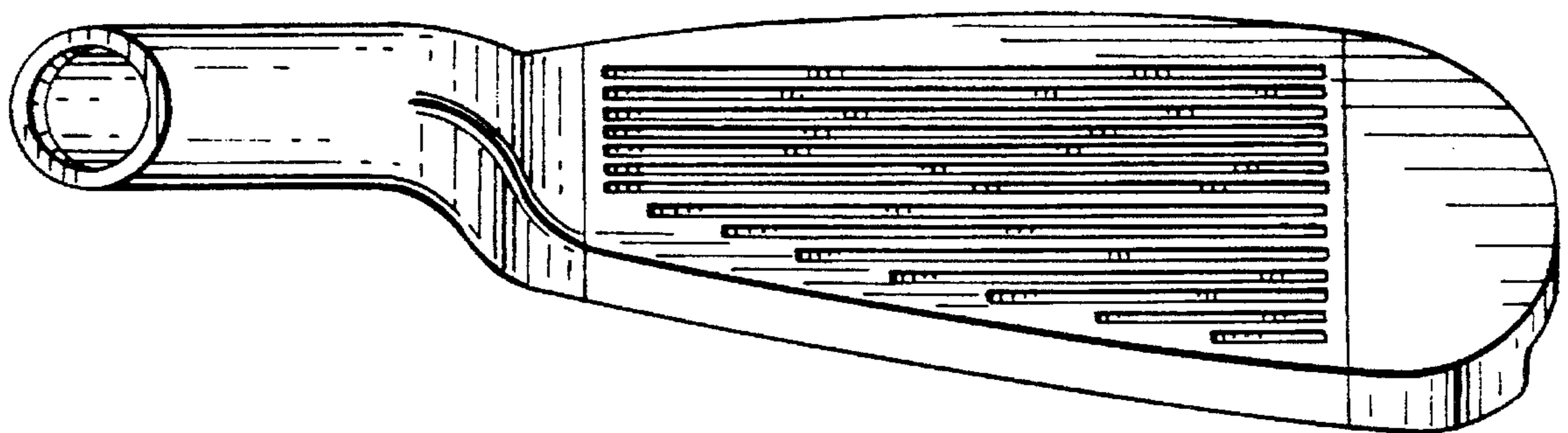

FIG. 3

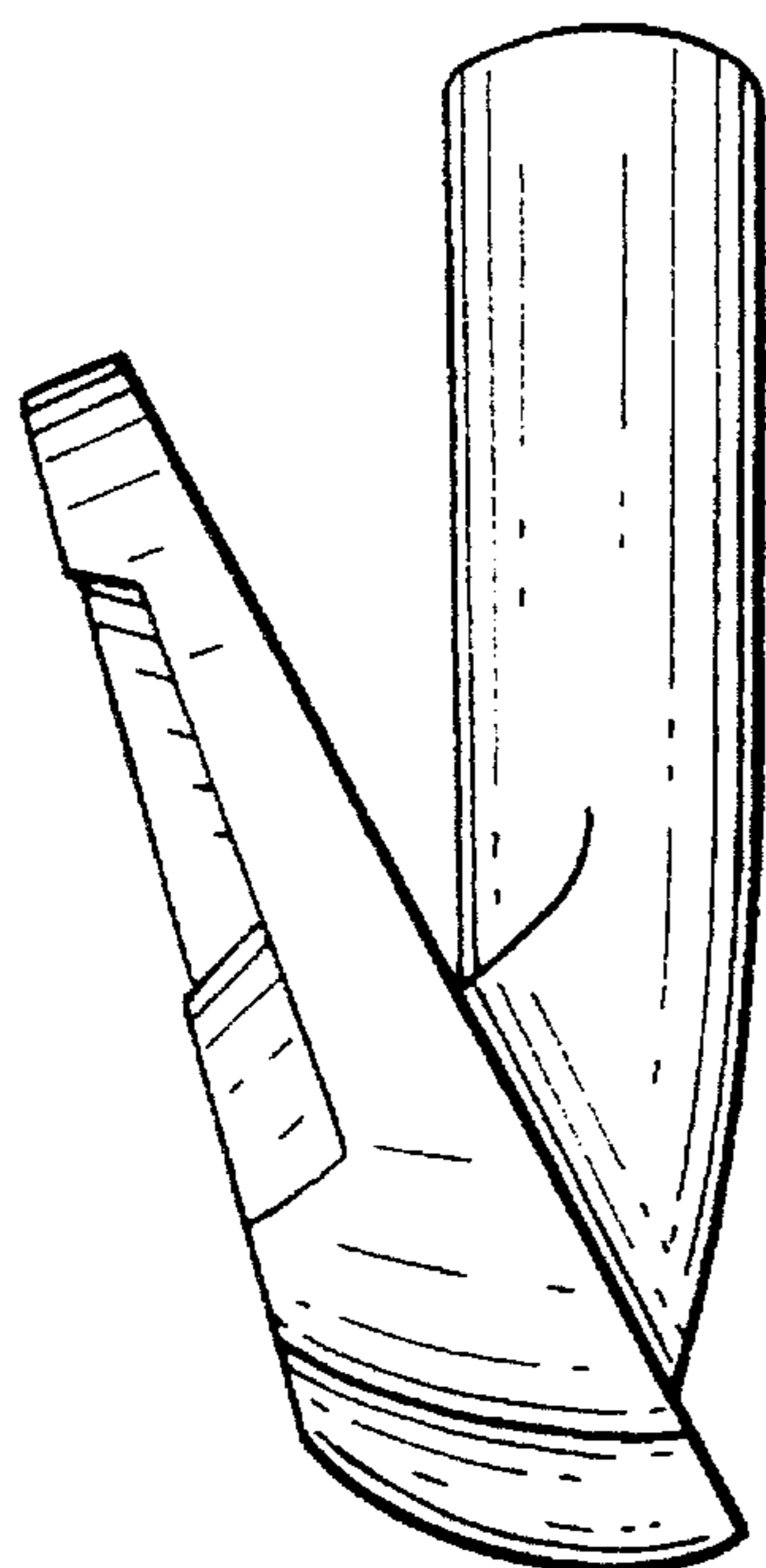

FIG. 4

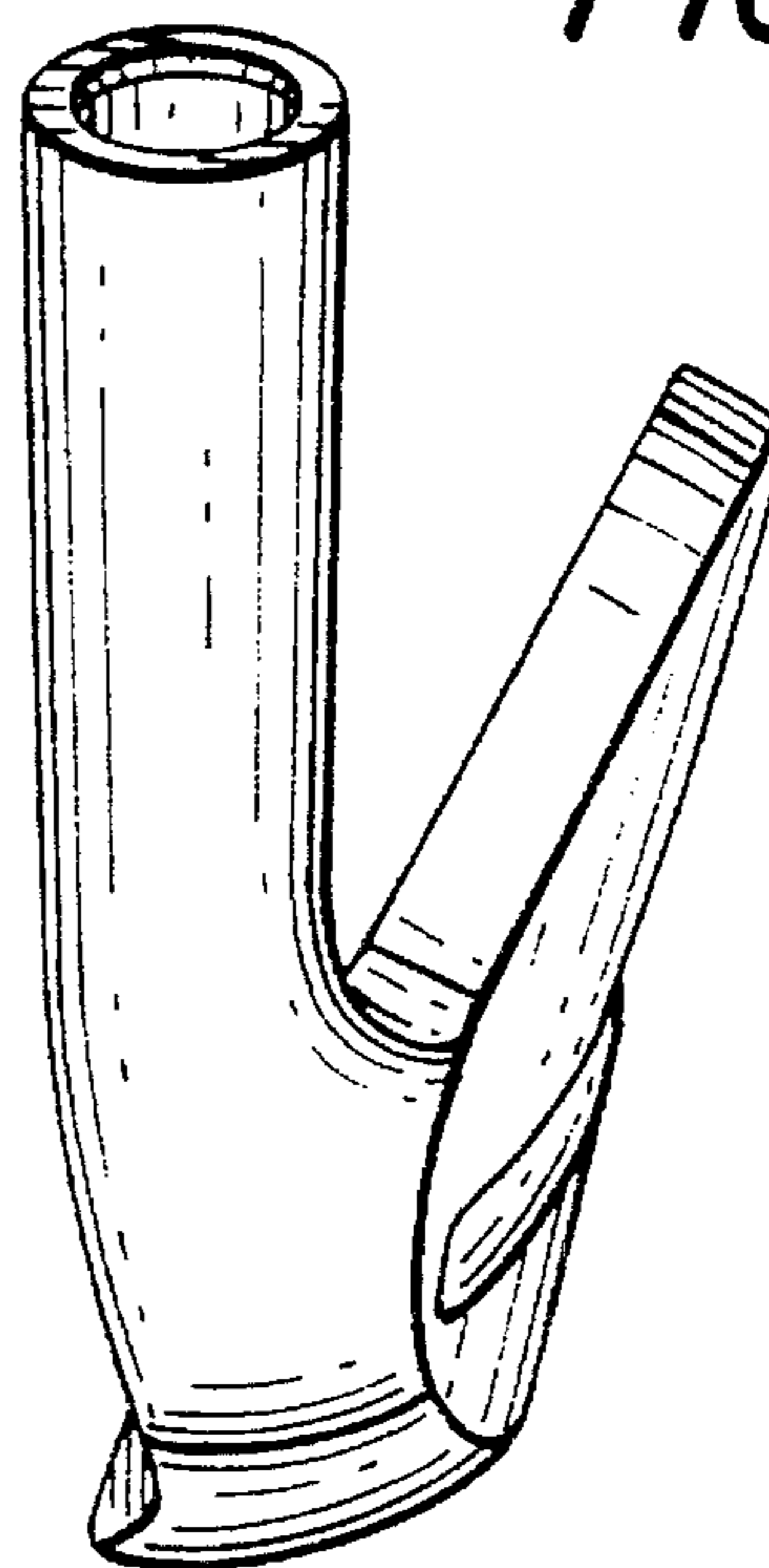

FIG. 5

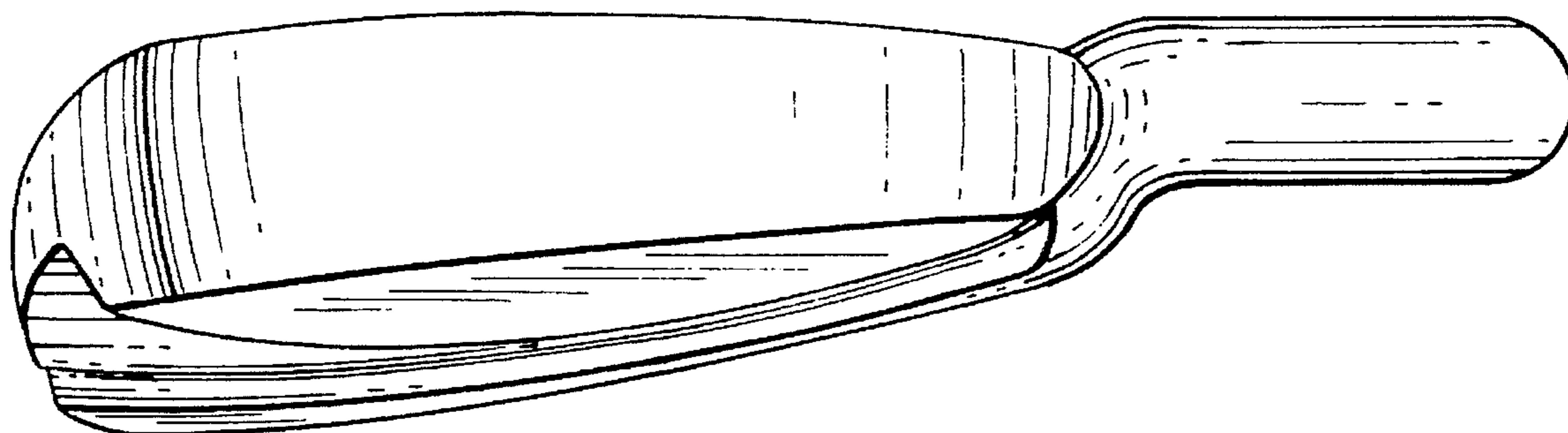

FIG. 6

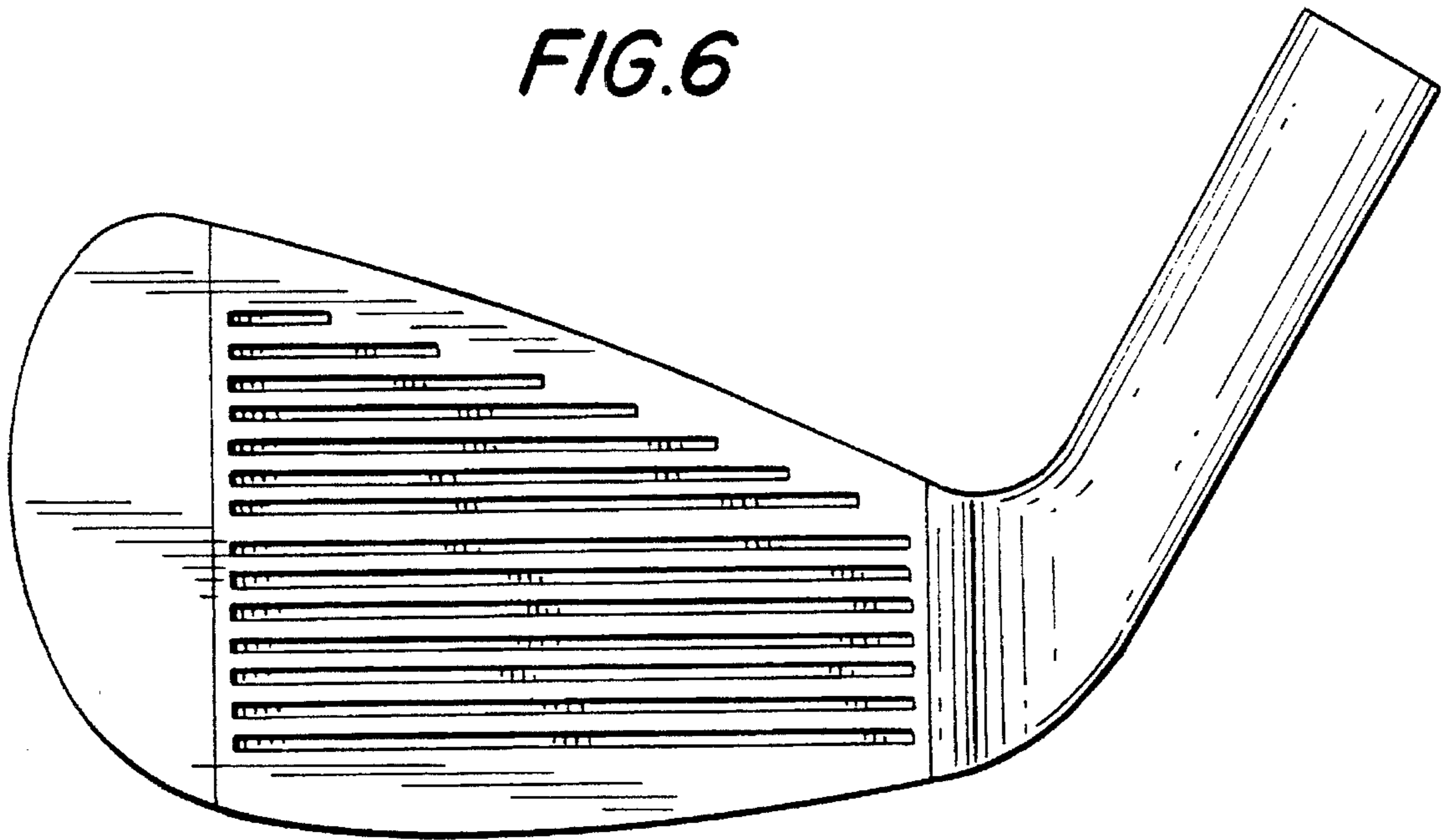

FIG. 7

