



US00D368735S

**United States Patent** [19]  
**Mason**

[11] **Patent Number:** **Des. 368,735**  
[45] **Date of Patent:** **\*\*Apr. 9, 1996**

[54] **FAMILY PHOTO ALBUM**

*Attorney, Agent, or Firm*—Richard C. Litman

[76] **Inventor:** **Catherine L. Mason**, 2121 Deerfield Ave., Myrtle Beach, S.C. 29575

[57] **CLAIM**

[\*\*] **Term:** **14 Years**

The ornamental design for a family photo album, as shown and described.

[21] **Appl. No.:** **32,183**

**DESCRIPTION**

[22] **Filed:** **Dec. 14, 1994**

[52] **U.S. Cl.** ..... **D19/26**

[58] **Field of Search** ..... **D19/26, 27, 28;**  
281/29, 31, 15.1, 21.1, 22; 402/75, 79,  
76, 73, 56

FIG. 1 is a perspective view of a family photo album showing my new design;

FIG. 2 is a front elevational view thereof;

FIG. 3 is a rear elevational view thereof;

FIG. 4 is a top view thereof, the bottom being a mirror image;

FIG. 5 is a left side elevational view thereof;

FIG. 6 is a right side elevational view thereof; and,

FIG. 7 is a perspective view thereof, in a fully opened position.

[56] **References Cited**

**U.S. PATENT DOCUMENTS**

D. 33,908	1/1901	Miller .....	D19/26
D. 138,689	9/1944	De Vry .....	D19/26
D. 196,099	8/1963	Sibley .....	D19/27
1,920,533	8/1933	Strauss .....	D19/26
5,277,452	1/1994	Skidmore .	

**OTHER PUBLICATIONS**

1994 Catalog of C. R. Gibson, a vendor of gifts, p. 79.

*Primary Examiner*—A. Hugo Word  
*Assistant Examiner*—Pamela Burgess

**1 Claim, 4 Drawing Sheets**

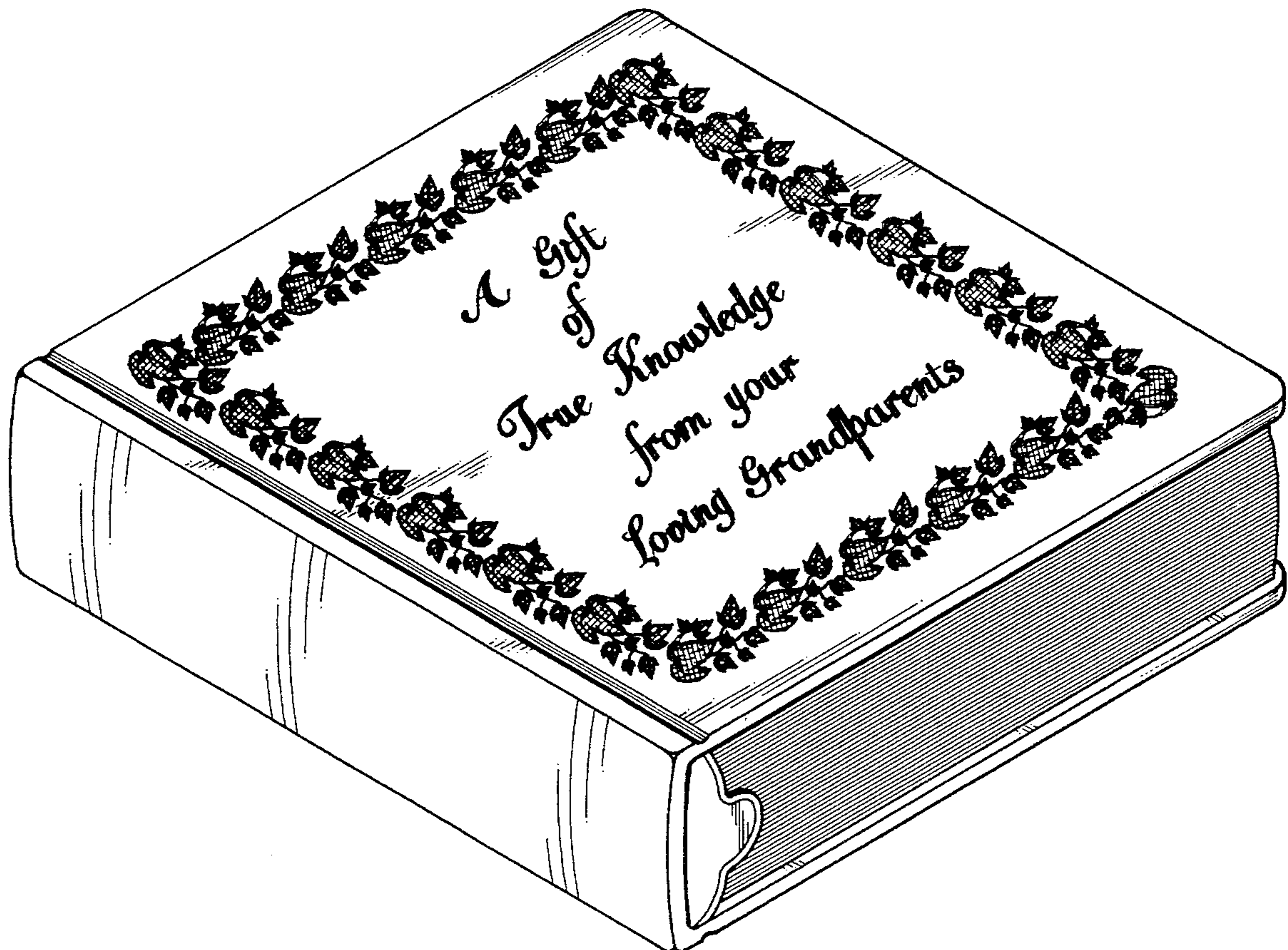

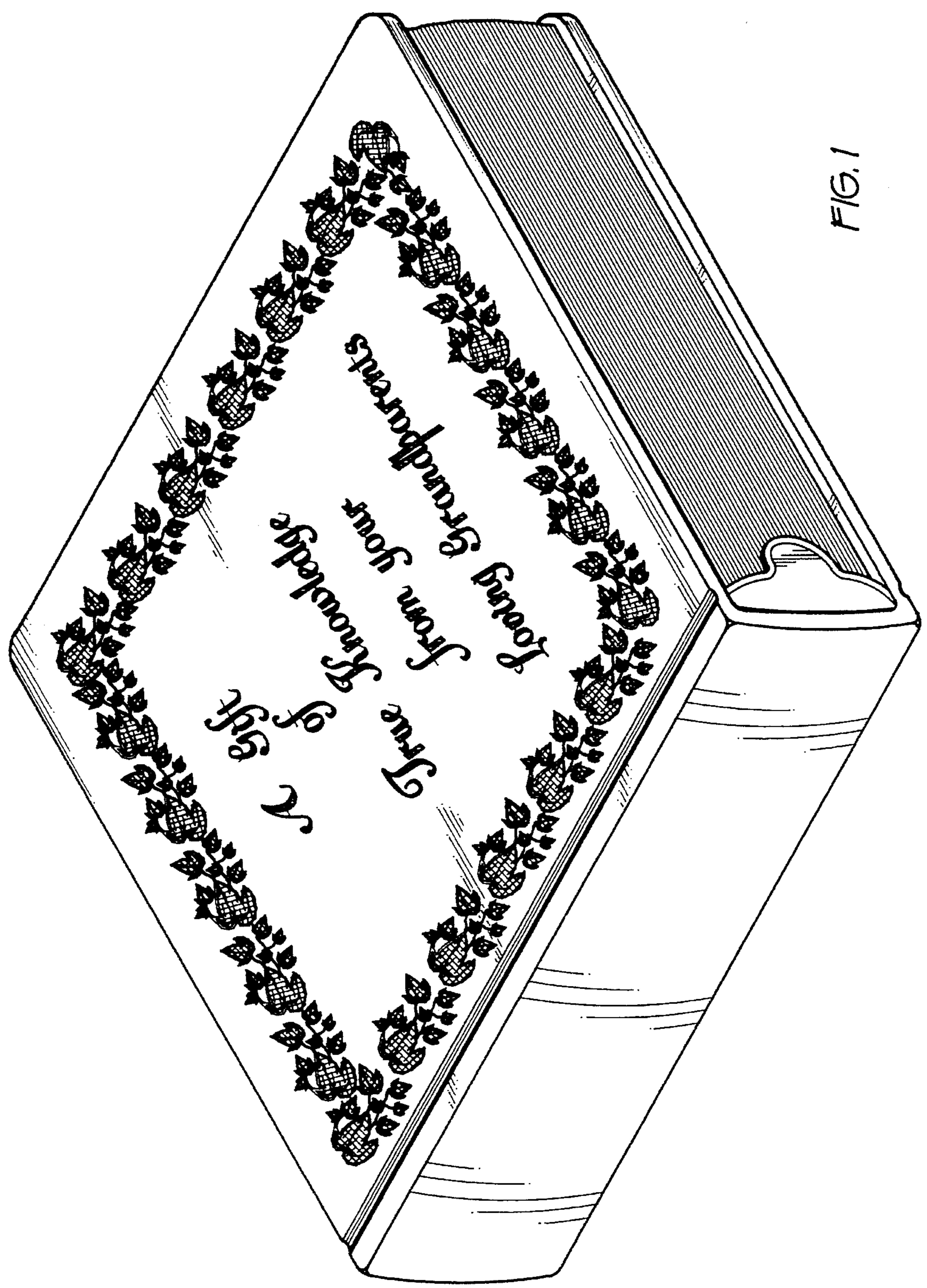

FIG. 1

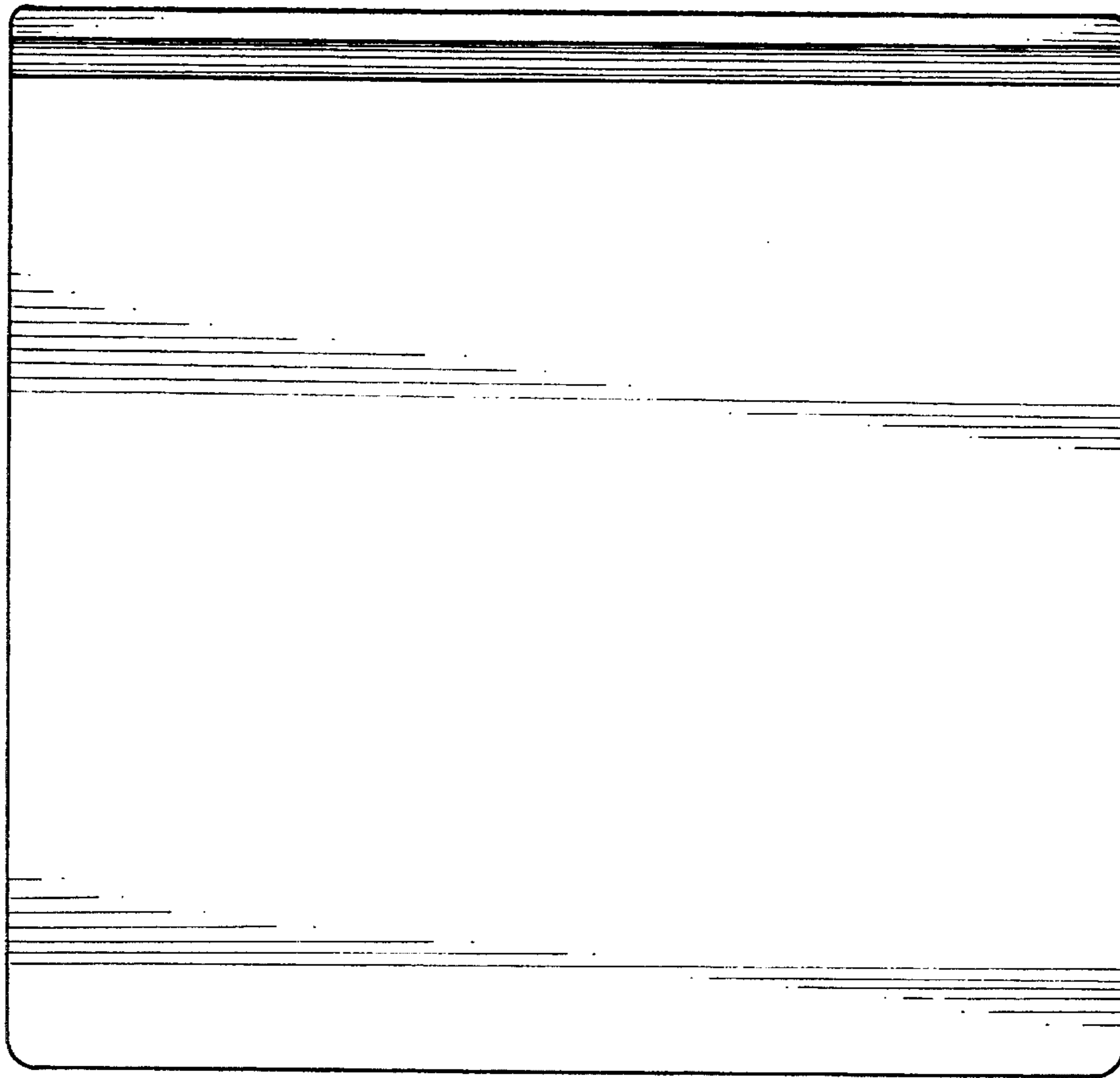

FIG. 3

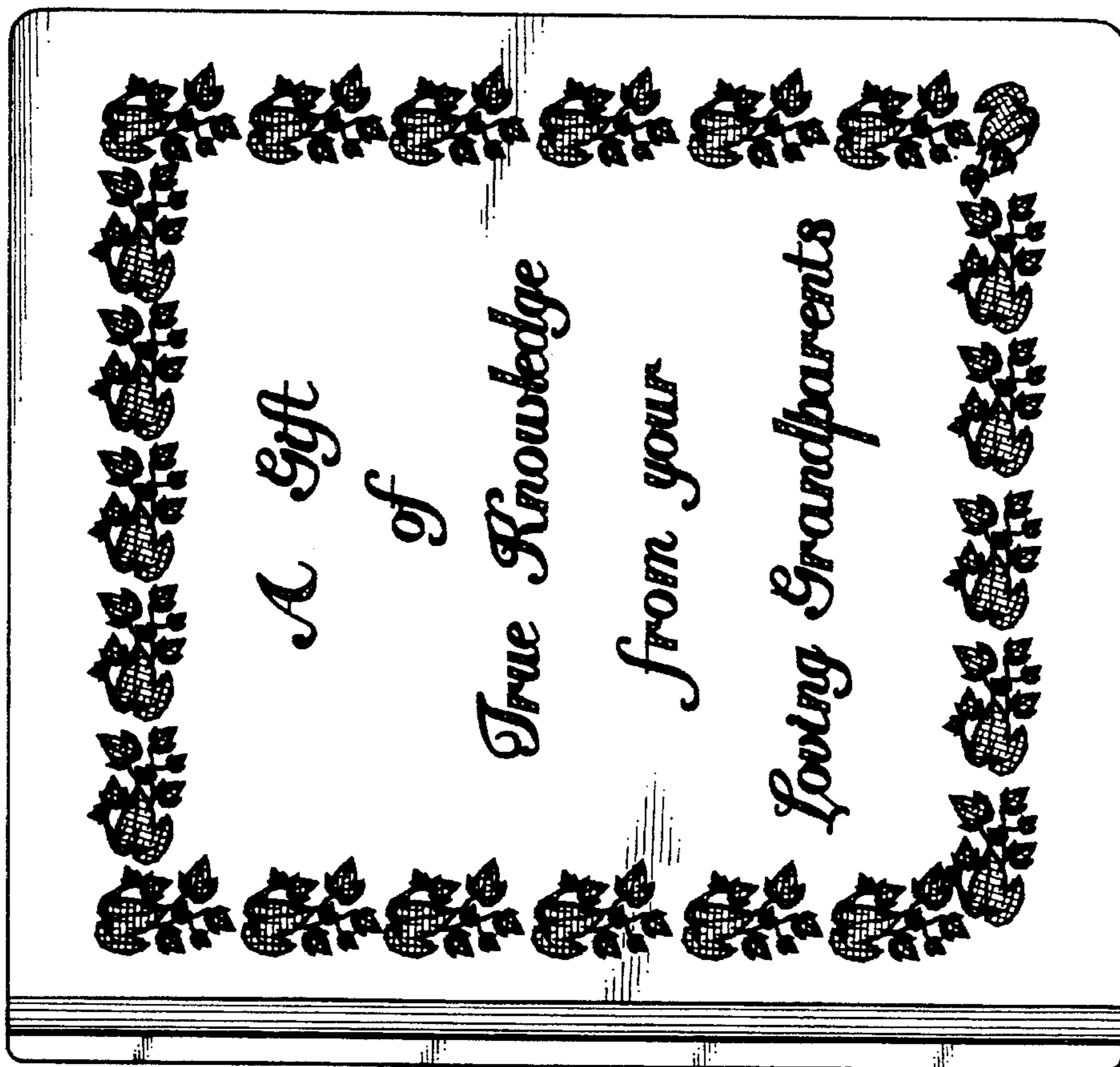

FIG. 2

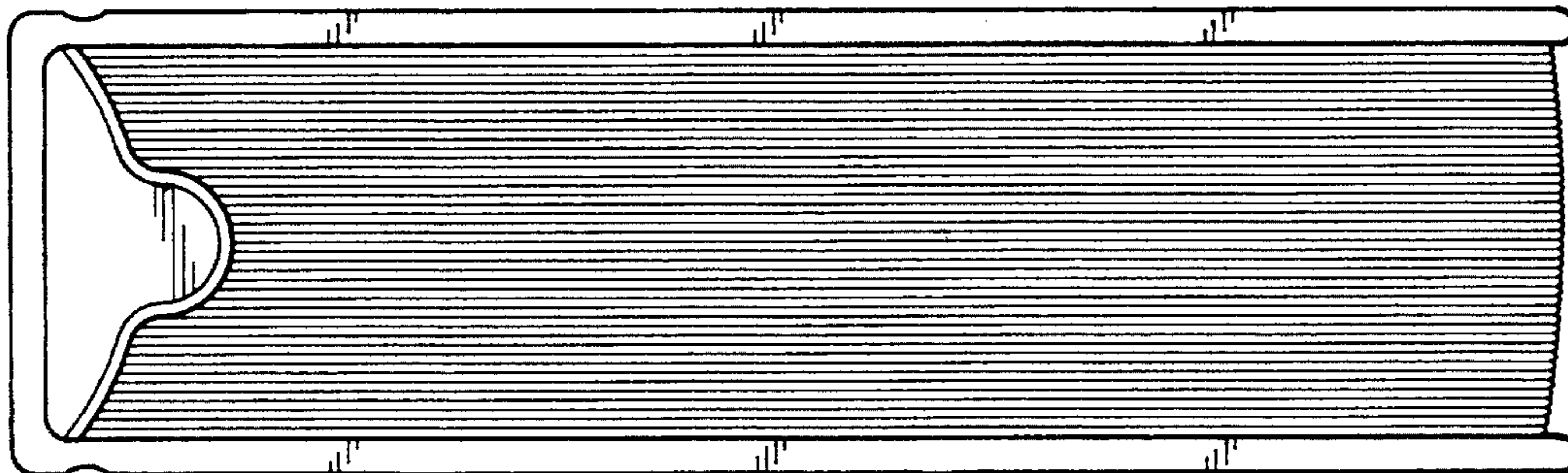

FIG. 4

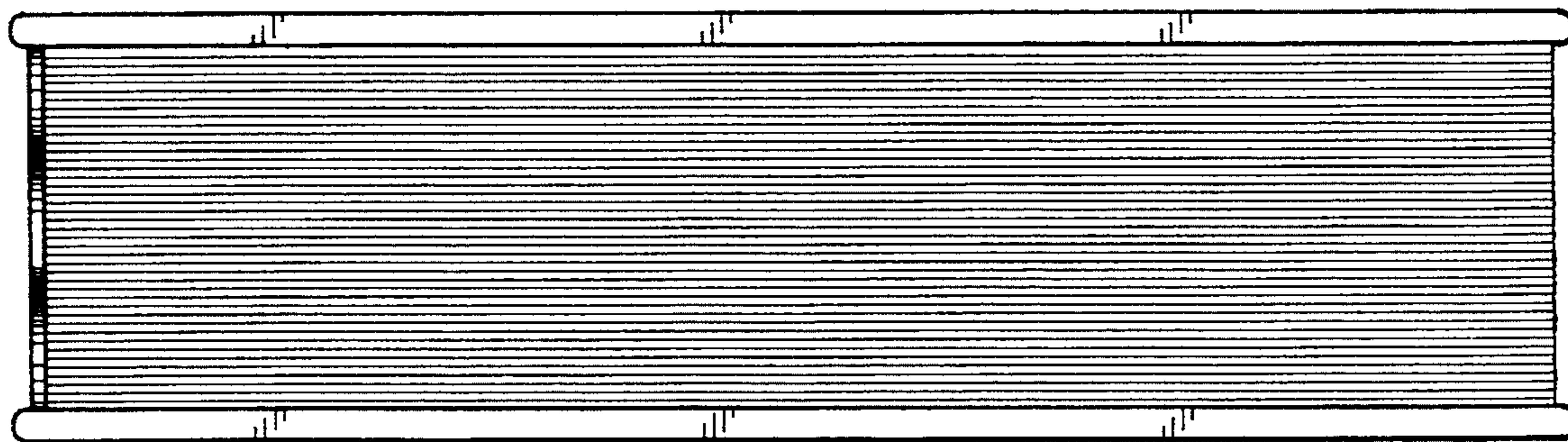

FIG. 5

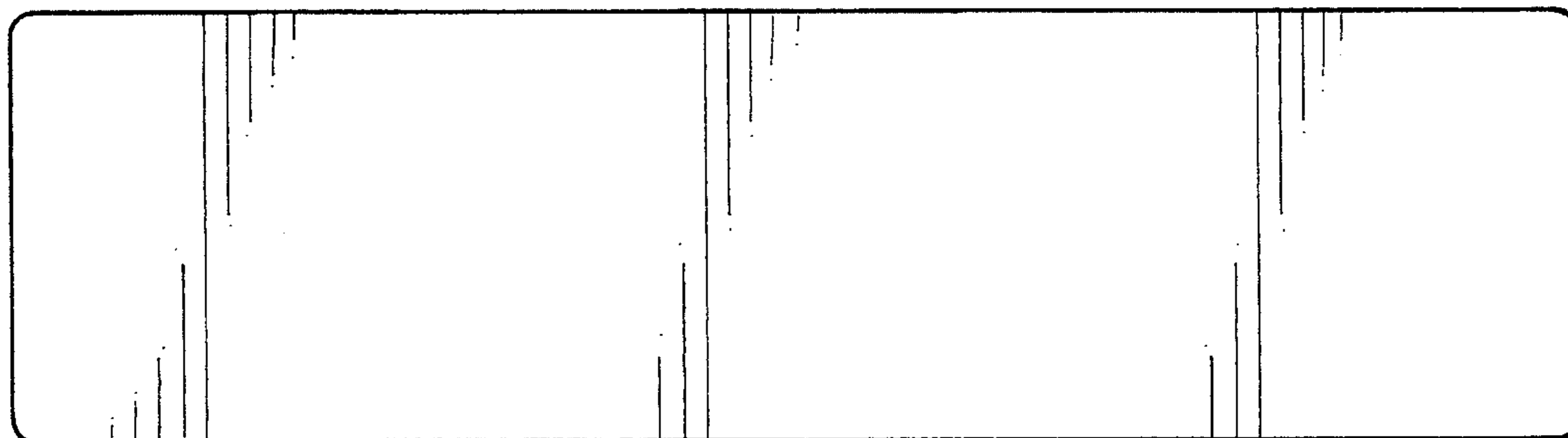

FIG. 6

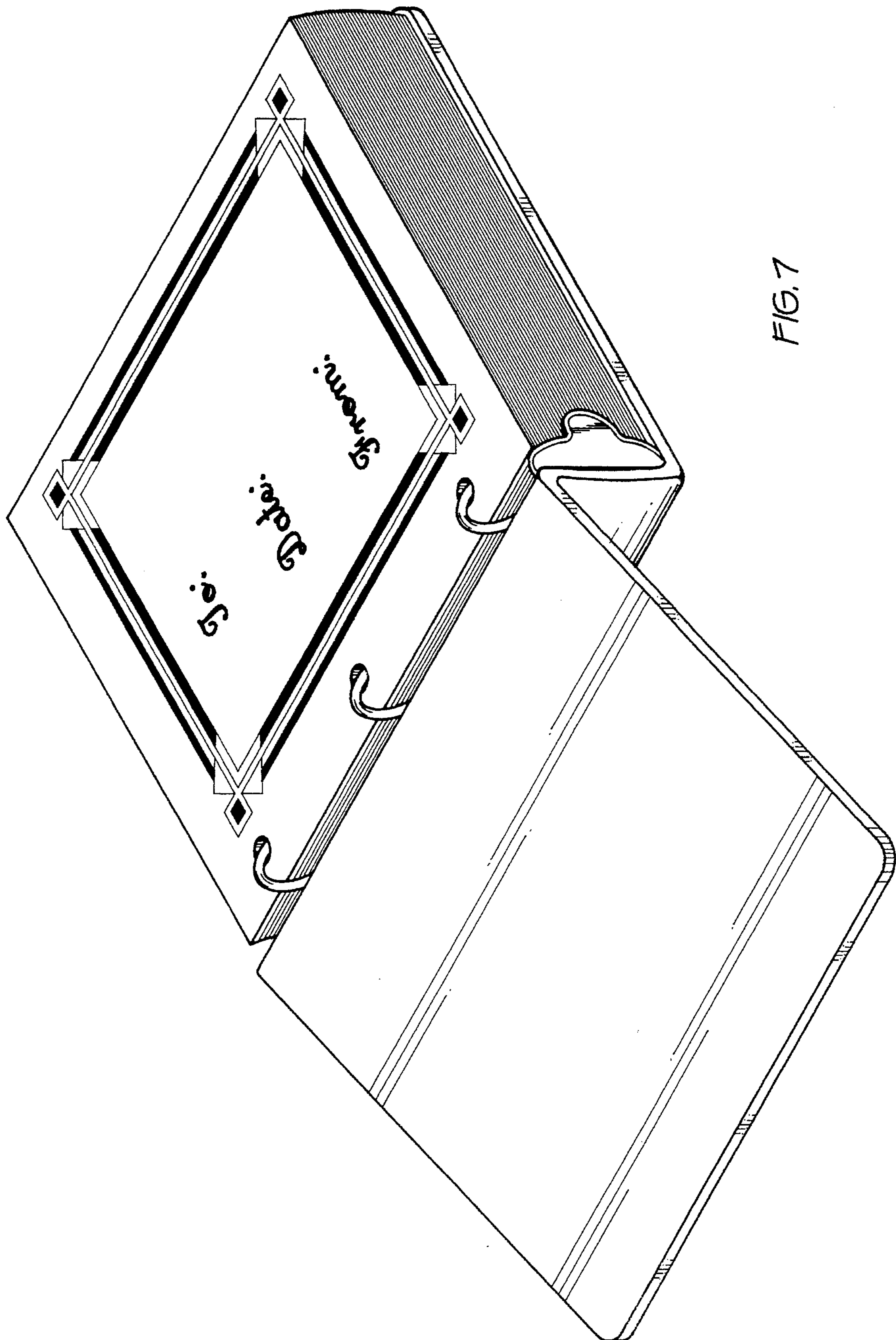

FIG. 7