



US00D368625S

# United States Patent [19] Rüttimann

[11] Patent Number: **Des. 368,625**  
[45] Date of Patent: **\*\*Apr. 9, 1996**

[54] **STAND FOR A KITCHEN FOOD MIXER**

[75] Inventor: **Max Rüttimann**, Märstatten,  
Switzerland

[73] Assignee: **ESGE AG**, Mettlen, Switzerland

[\*\*] Term: **14 Years**

[21] Appl. No.: **16,497**

[22] Filed: **Dec. 16, 1994**

[30] **Foreign Application Priority Data**

Jul. 21, 1993 [WO] WIPO ..... D026754

[52] U.S. Cl. .... **D7/412**

[58] Field of Search ..... D7/412, 376-386,  
D7/637, 641; 312/280, 206-208, 236, 237,  
328, 351, 290; 206/373, 349

[56] **References Cited**

### U.S. PATENT DOCUMENTS

D. 141,958 8/1945 Glass ..... D7/637  
D. 201,145 5/1965 Hall ..... D7/637

D. 204,479 4/1966 Cassidy ..... D7/637  
D. 215,872 11/1969 Price et al. .... D7/637  
D. 278,506 4/1985 Kafka ..... D7/376  
D. 287,810 1/1987 Osit ..... D7/376 X

*Primary Examiner*—Alan P. Douglas  
*Assistant Examiner*—Caron D. Veynar  
*Attorney, Agent, or Firm*—Frishauf, Holtz, Goodman,  
Langer & Chick

### [57] CLAIM

The ornamental design for a stand for a kitchen food mixer,  
as shown.

### DESCRIPTION

FIG. 1 is a front—right perspective view;  
FIG. 2 is a rear perspective view, taken from the top;  
FIG. 3 is a top view;  
FIG. 4 is a front view;  
FIG. 5 is a left side view;  
FIG. 6 is a right side view;  
FIG. 7 is a rear view; and,  
FIG. 8 is a bottom view.

**1 Claim, 5 Drawing Sheets**

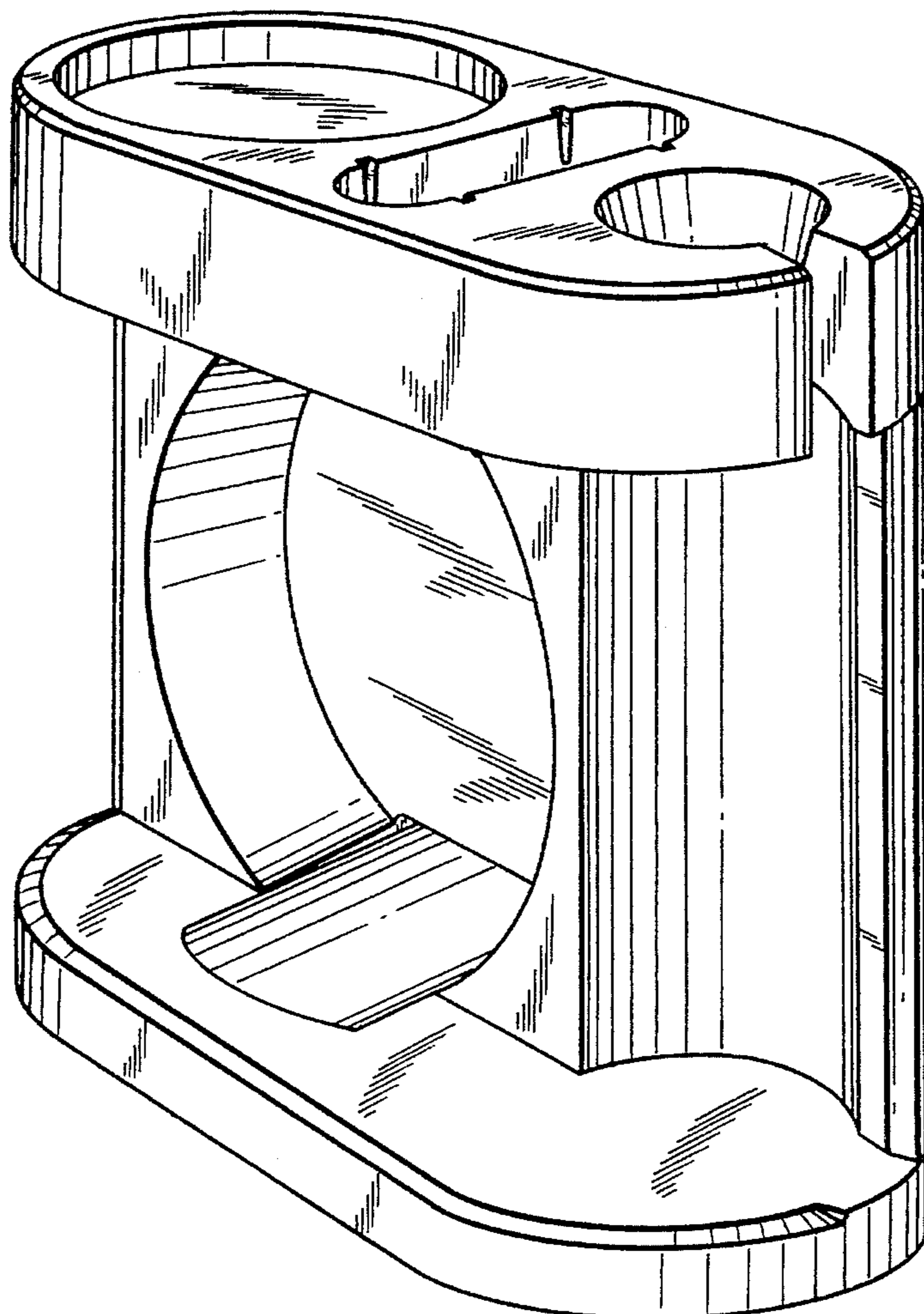

FIG. 1

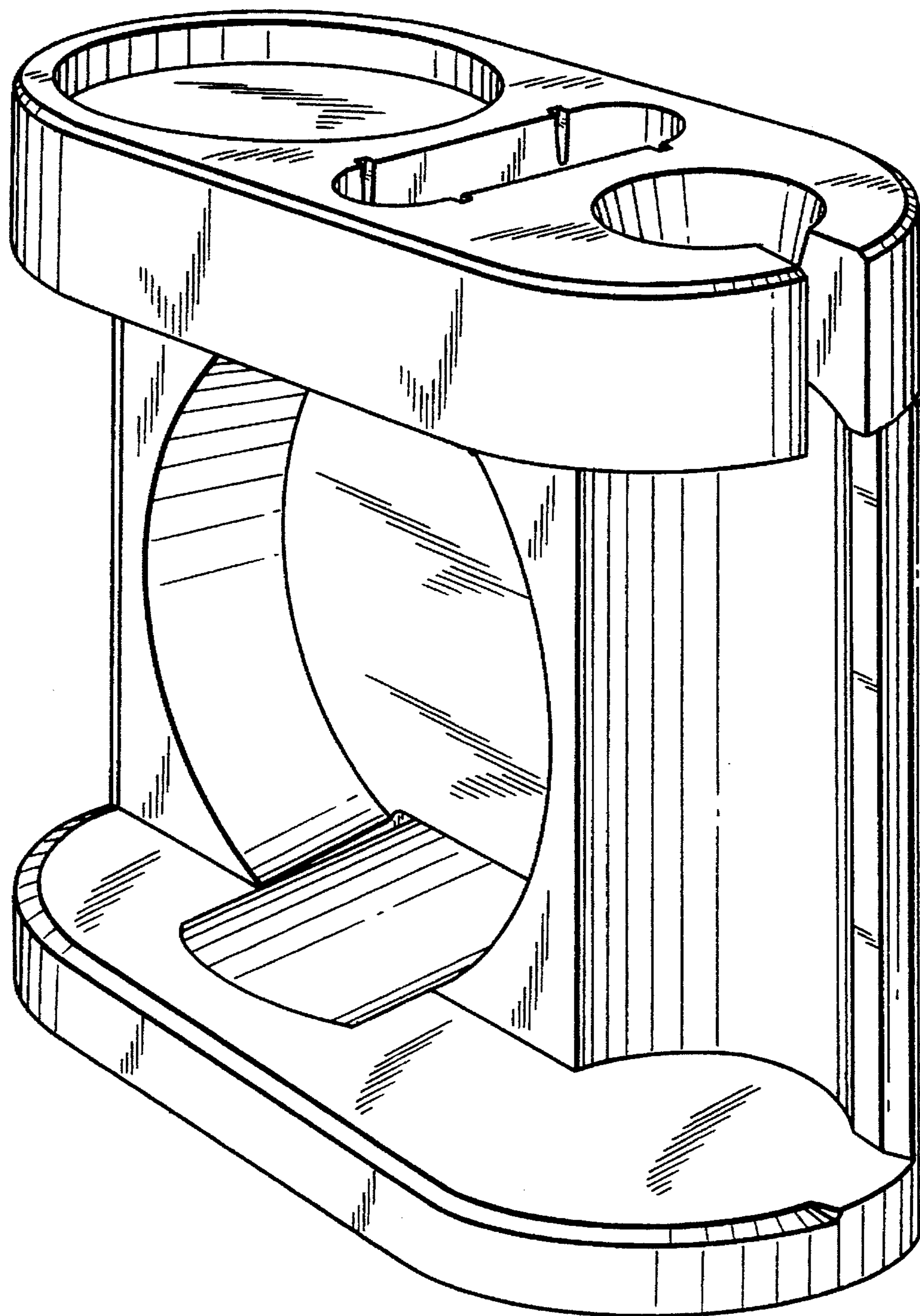
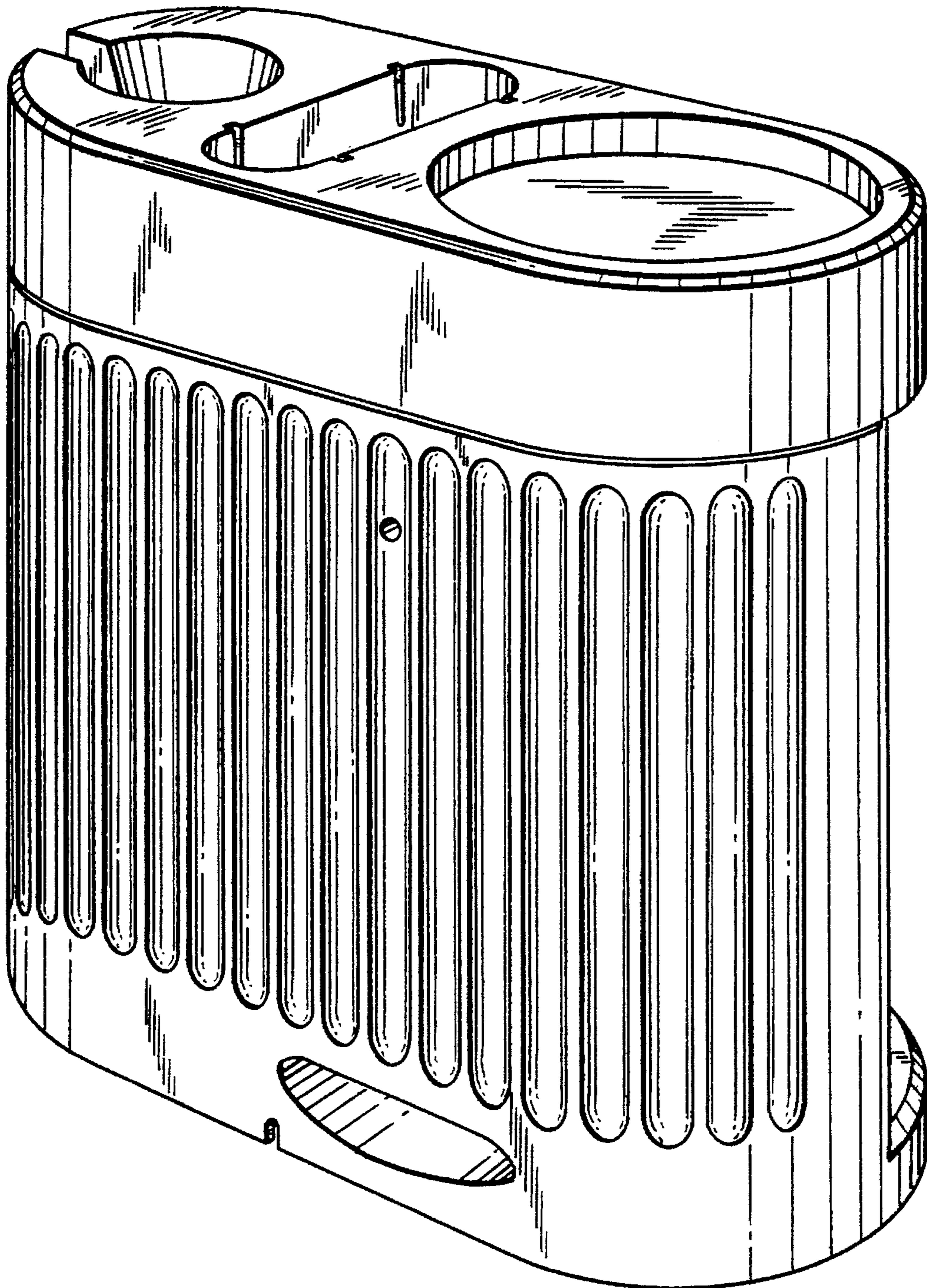

FIG. 2



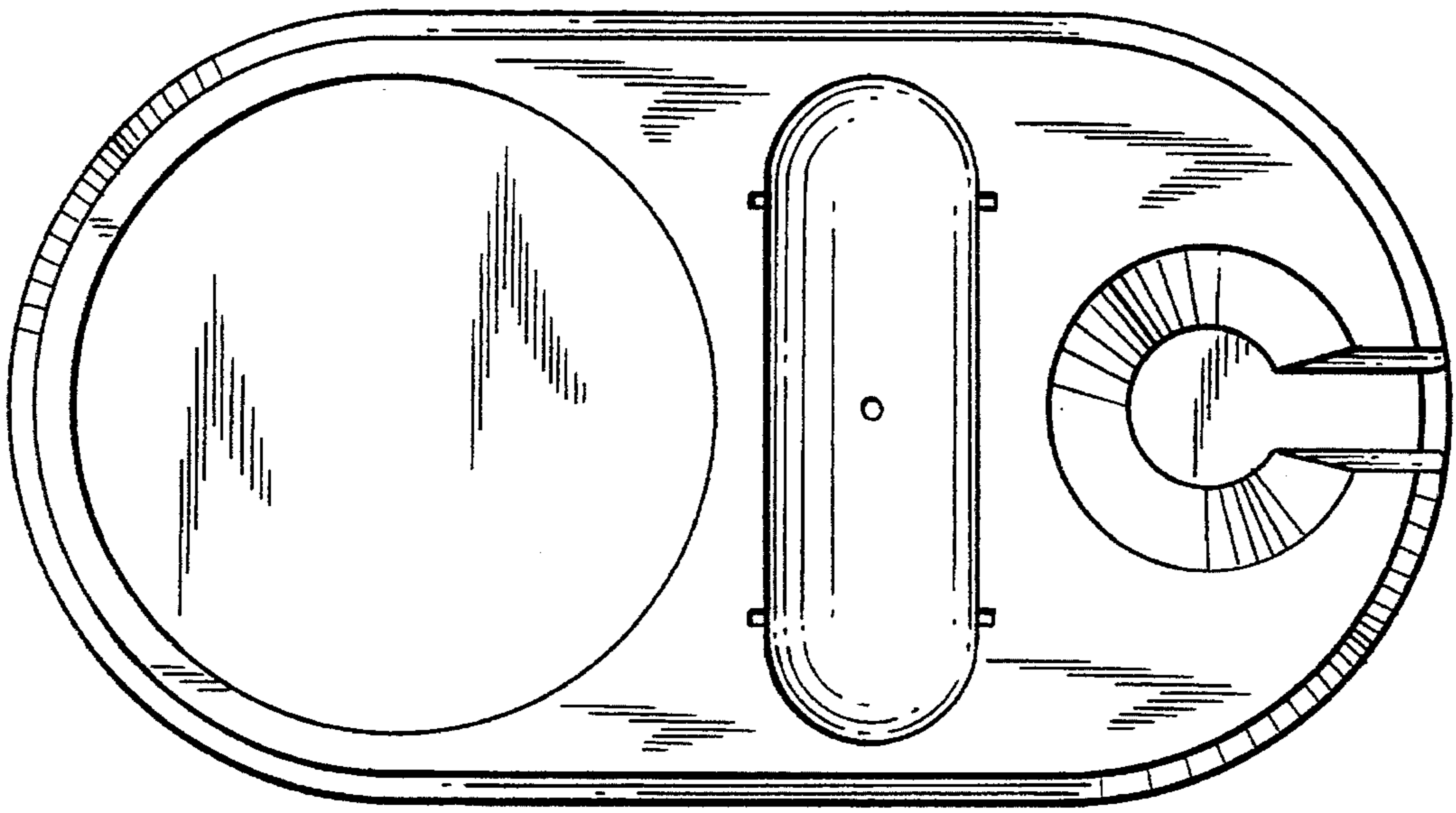
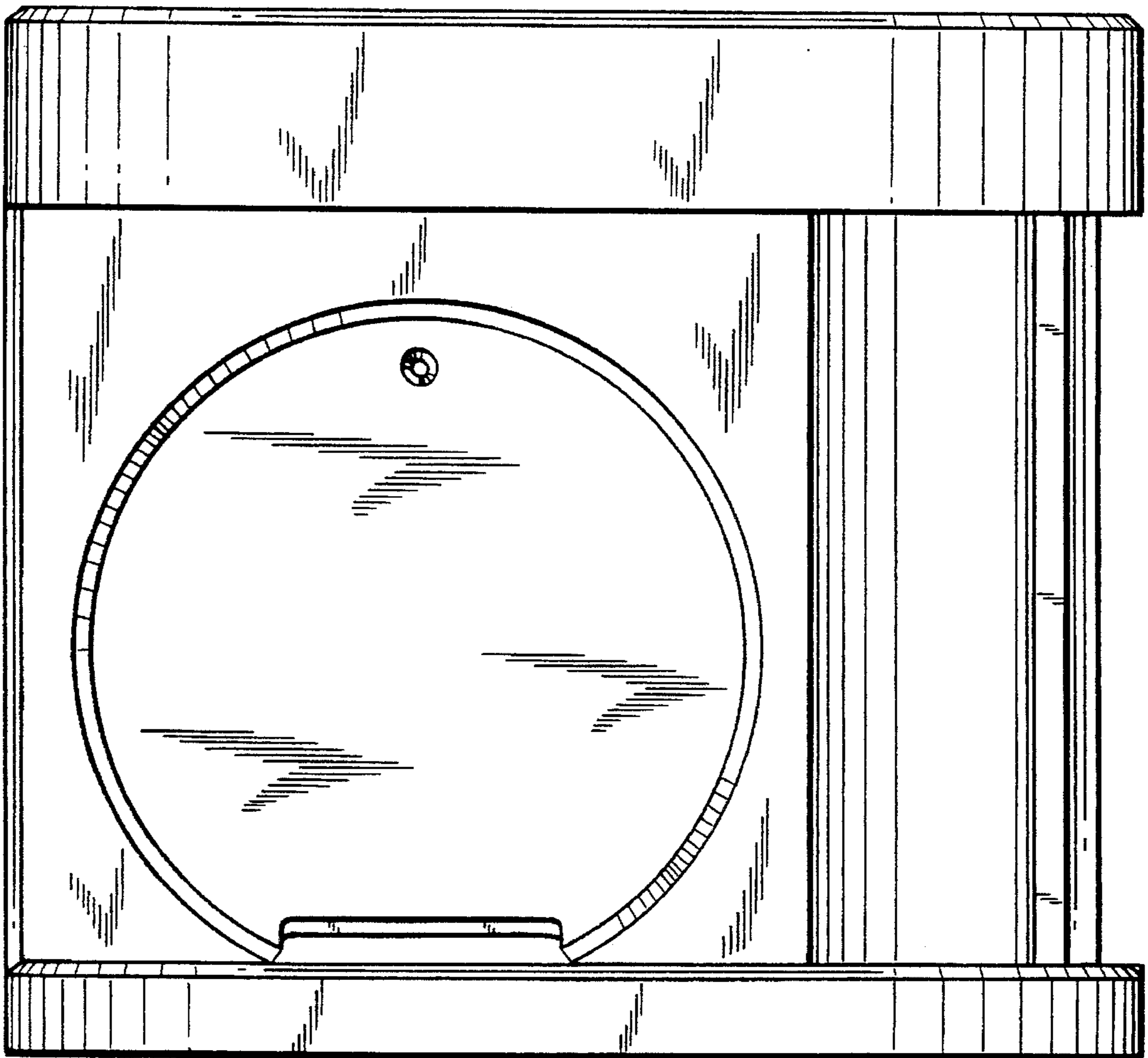

FIG. 3

FIG. 4



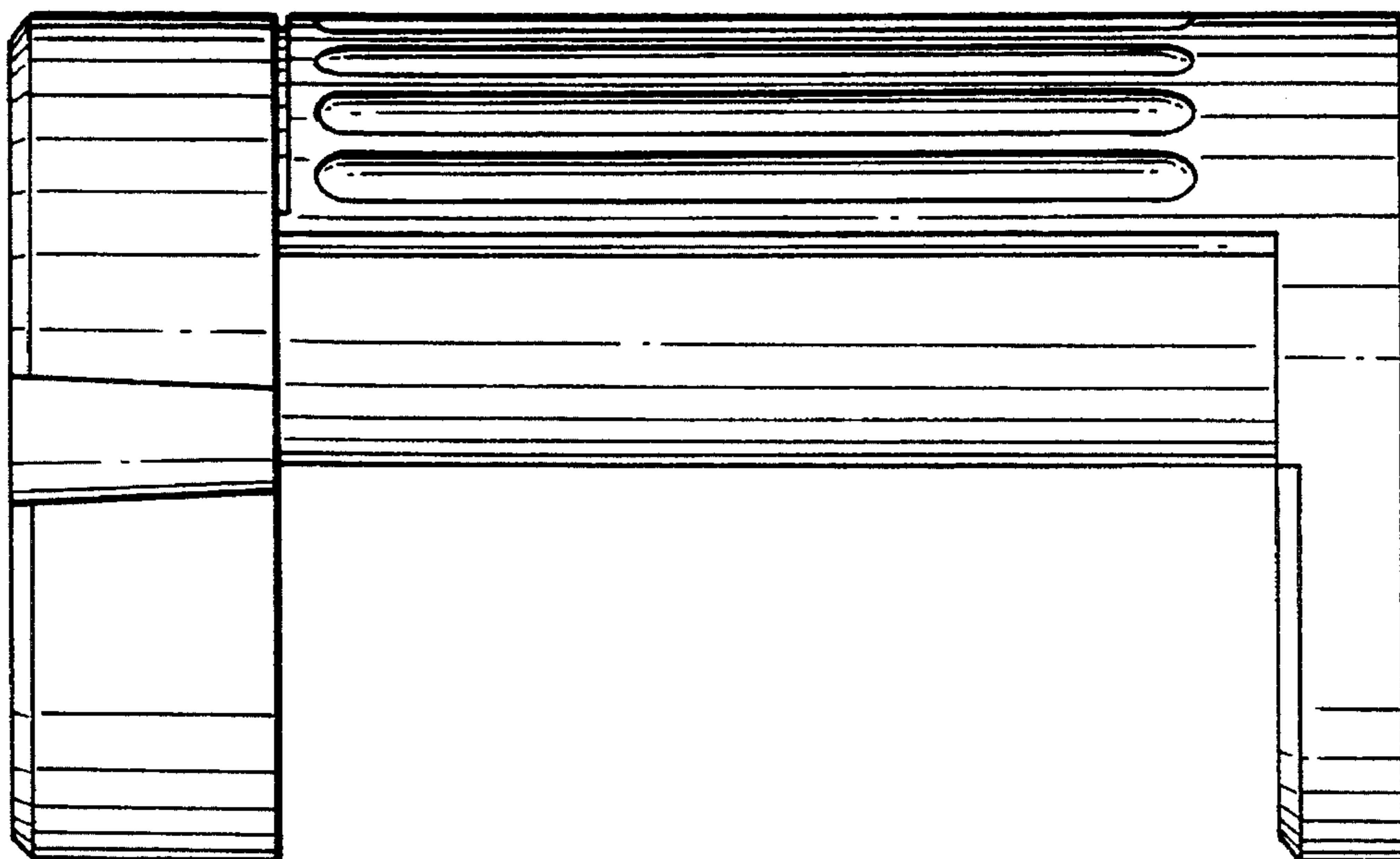

FIG. 6

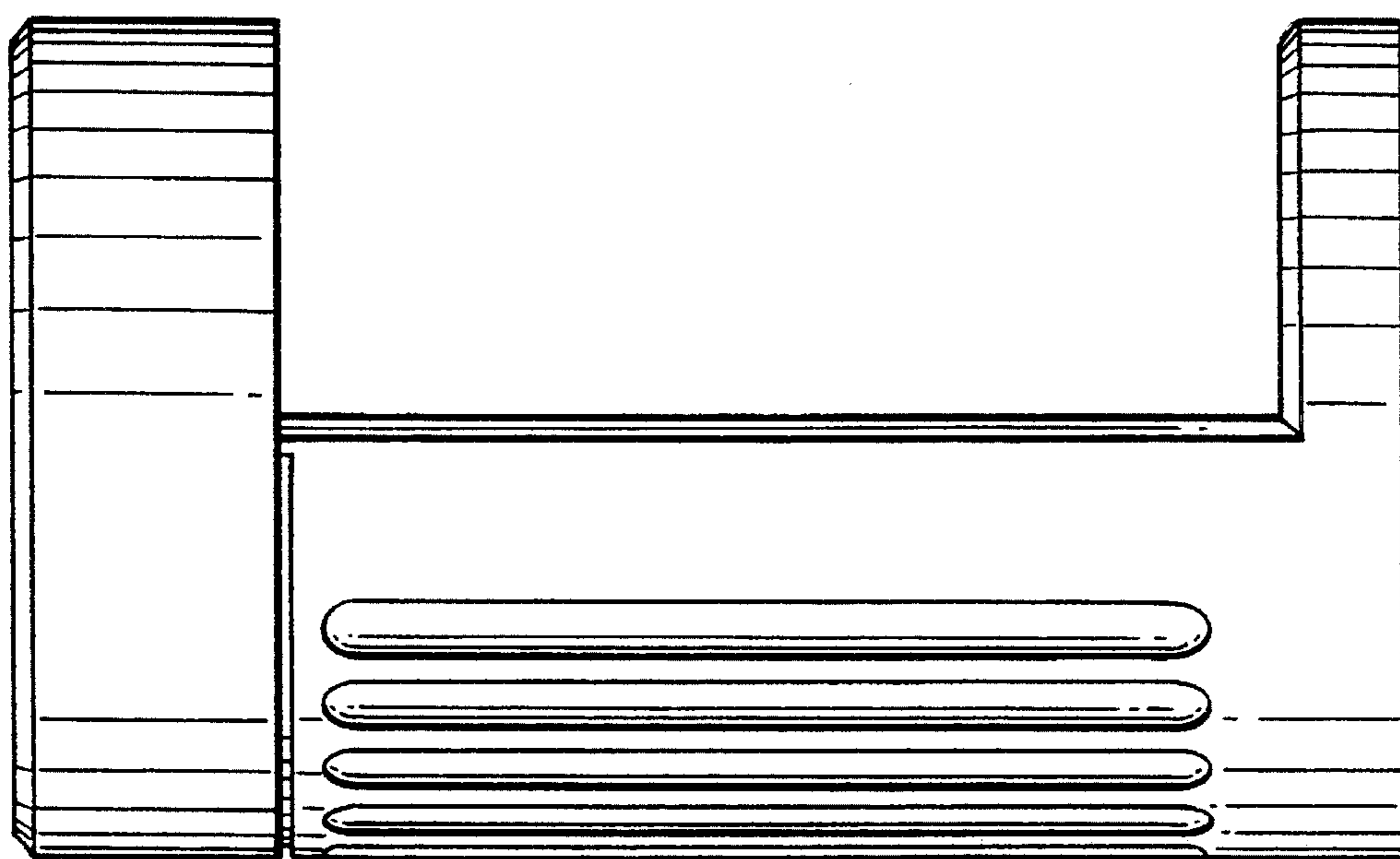

FIG. 5

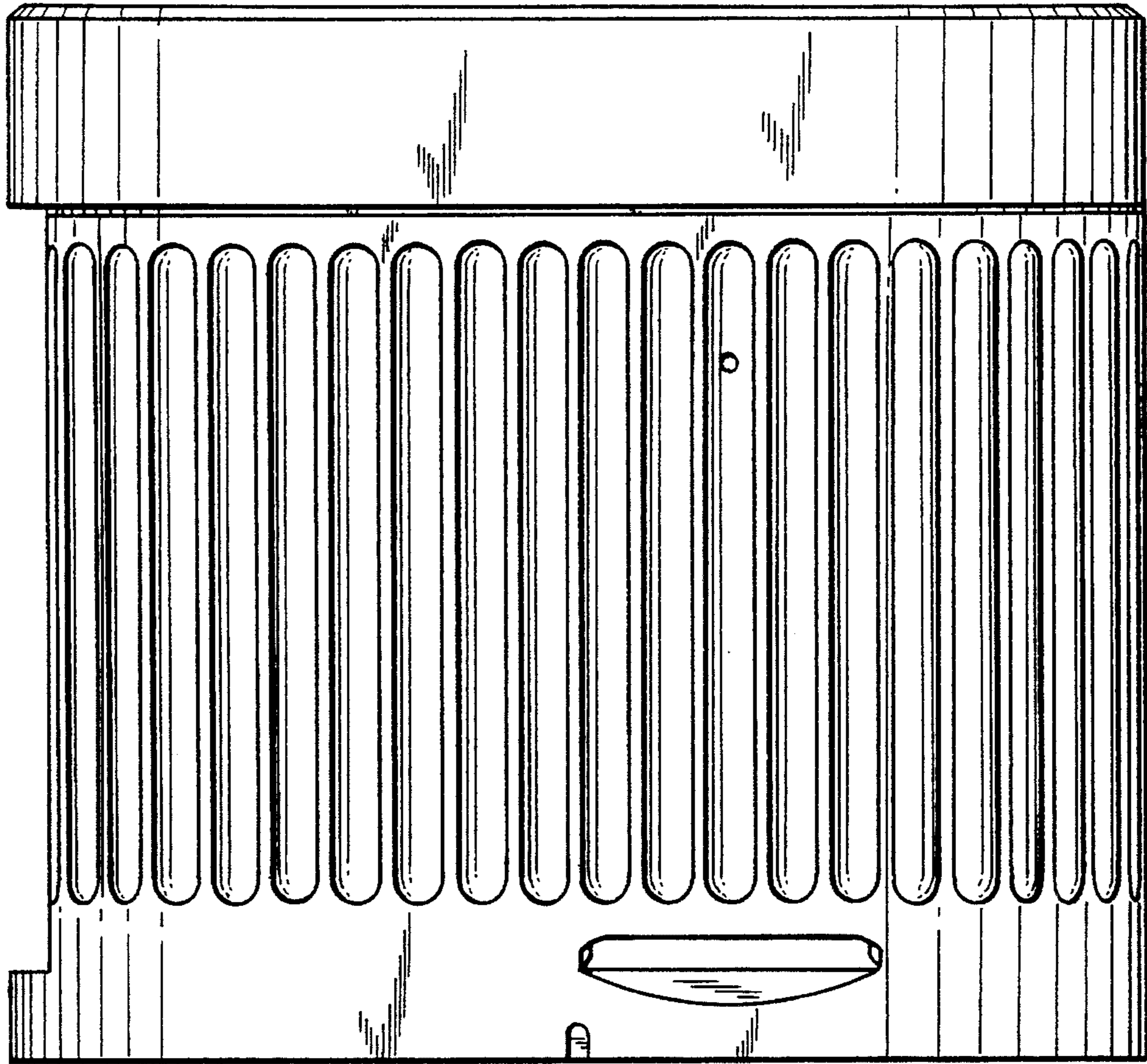

FIG. 7

FIG. 8

