



US00D368482S

# United States Patent [19]

[11] Patent Number: **Des. 368,482**

**Bone**

[45] Date of Patent: **\*\*Apr. 2, 1996**

[54] **COMBINED REFRIGERATOR AND MICROWAVE OVEN**

Sweets General Building—Renovation 1994 Catalog File vol. 13 Dwyer p. 6, wet bar.

[76] Inventor: **Charles A. Bone**, 235 Sandringham Ct., Knoxville, Tenn. 37922

*Primary Examiner*—Sandra L. Morris  
*Attorney, Agent, or Firm*—Michael E. McKee

[\*\*] Term: **14 Years**

[57] **CLAIM**

[21] Appl. No.: **37,637**

The ornamental design for a combined refrigerator and microwave oven, as shown and described.

[22] Filed: **Apr. 18, 1995**

[52] U.S. Cl. .... **D15/81; D7/351**

**DESCRIPTION**

[58] **Field of Search** ..... D7/350-351; D6/470-472, D6/397, 432; D15/79-91; 62/246-252, 371, 444, 445, 457.1; 312/114, 116, 128, 236, 237

FIG. 1 is an enlarged perspective view of a combined refrigerator and microwave oven, showing my new design, the door of the storage compartment is shown in a closed position;

[56] **References Cited**

FIG. 2 is a front elevational view thereof;

**U.S. PATENT DOCUMENTS**

FIG. 3 is a right side elevational view thereof, the opposite side being a mirror image;

D. 252,730	8/1979	Mazurosky	.....	D15/81
D. 286,882	11/1986	Hong	.....	D15/81
D. 300,898	5/1989	Kido et al.	.....	D7/351
D. 324,466	3/1992	Yamagami et al.	.....	D7/351

FIG. 4 is a rear elevational view thereof;

FIG. 5 is a top plan view thereof;

**FOREIGN PATENT DOCUMENTS**

4194575	7/1992	Japan	.....	62/246
---------	--------	-------	-------	--------

FIG. 6 is an enlarged perspective view thereof, the door of the storage compartment is shown in an opened position;

FIG. 7 is a front elevational view of another embodiment of a combined refrigerator and microwave oven; and,

FIG. 8 is a right side view thereof, the opposite side being a mirror image.

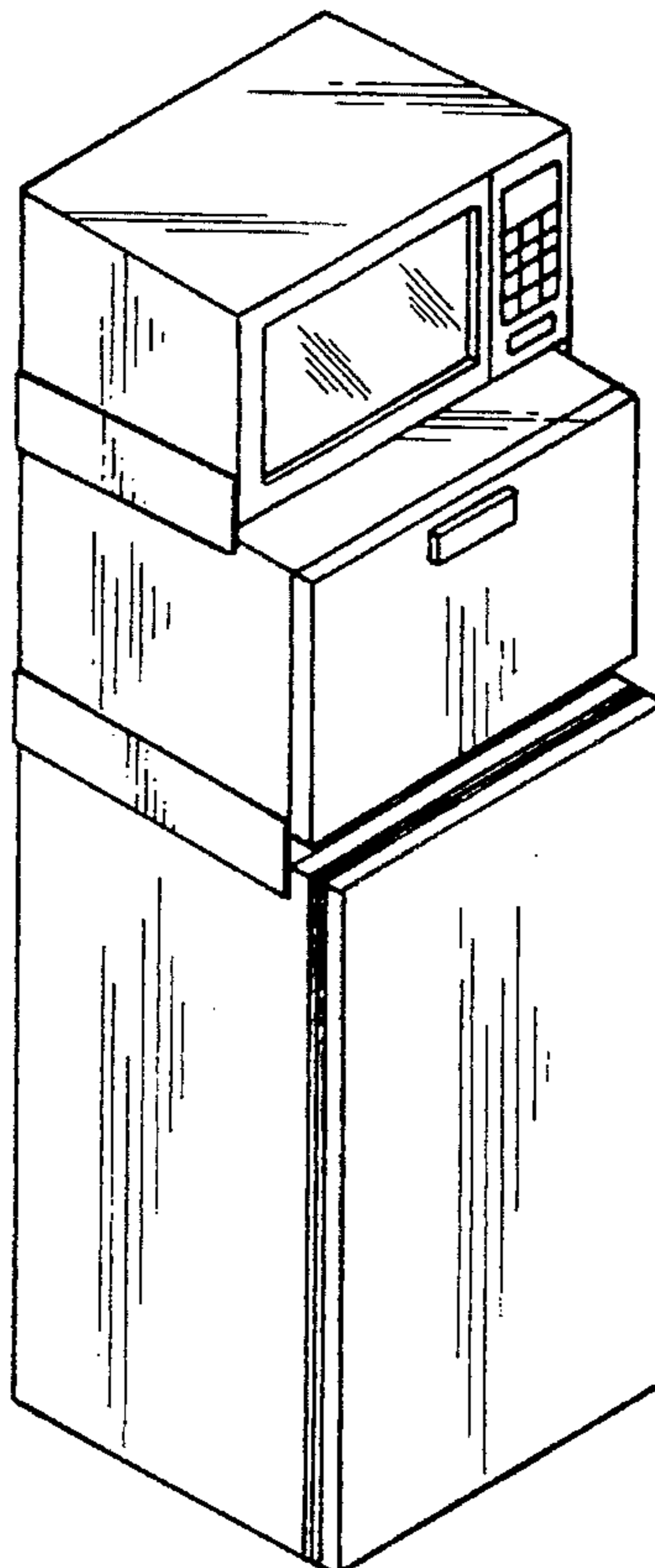
**OTHER PUBLICATIONS**

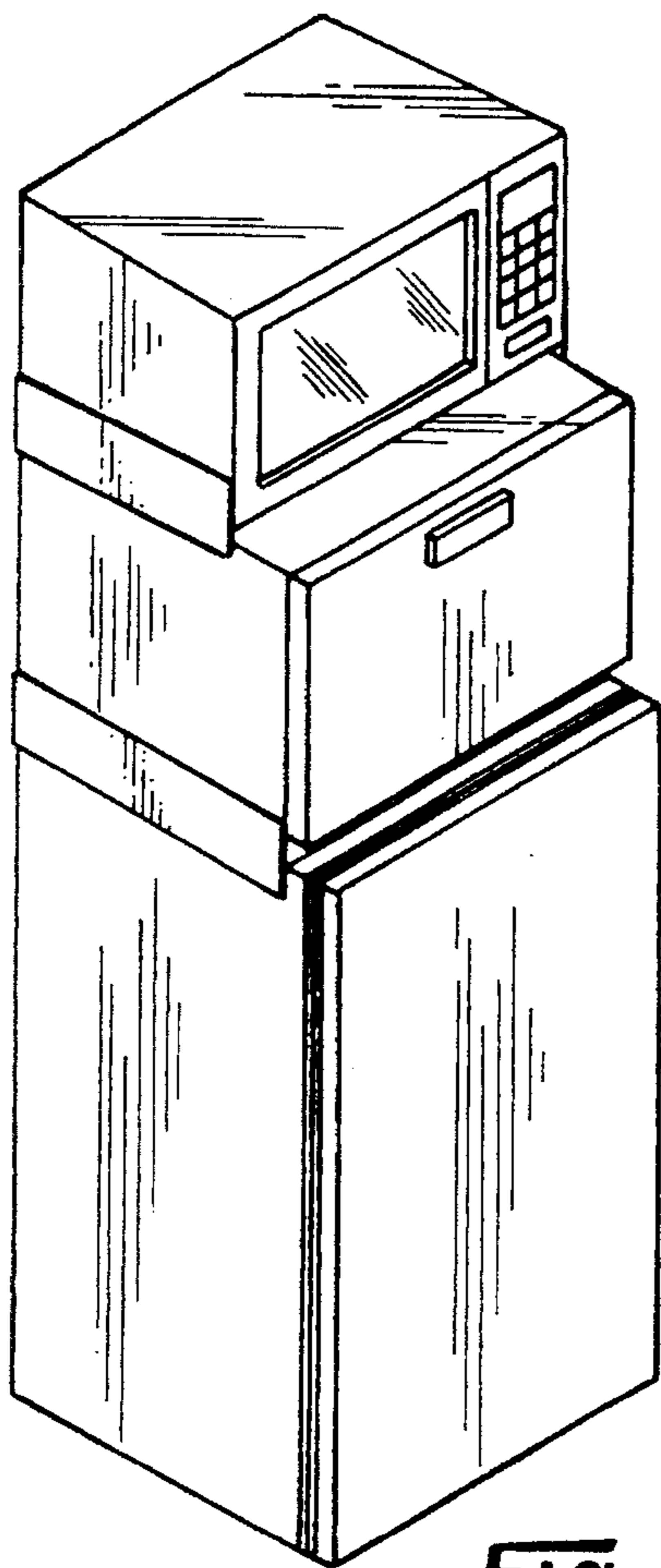
Montgomery Ward Spring Summer 1985 Catalog p. 185 compact kitchen "K".

The bottom view of the design is plain.

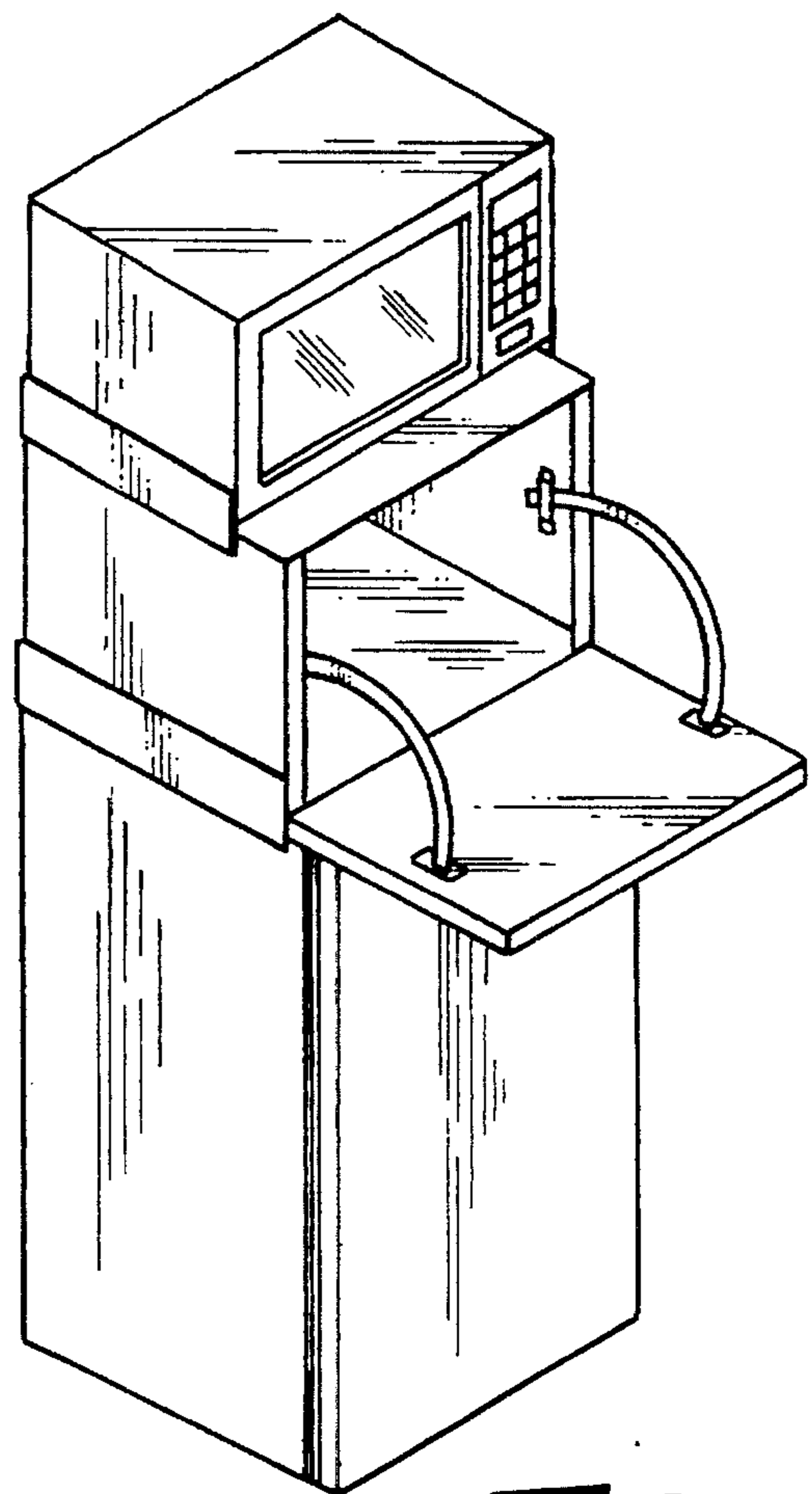
Sweets General Building & Renovation 1994 Catalog File vol. 13 Cervitor, p. 8, RE-30.

**1 Claim, 2 Drawing Sheets**

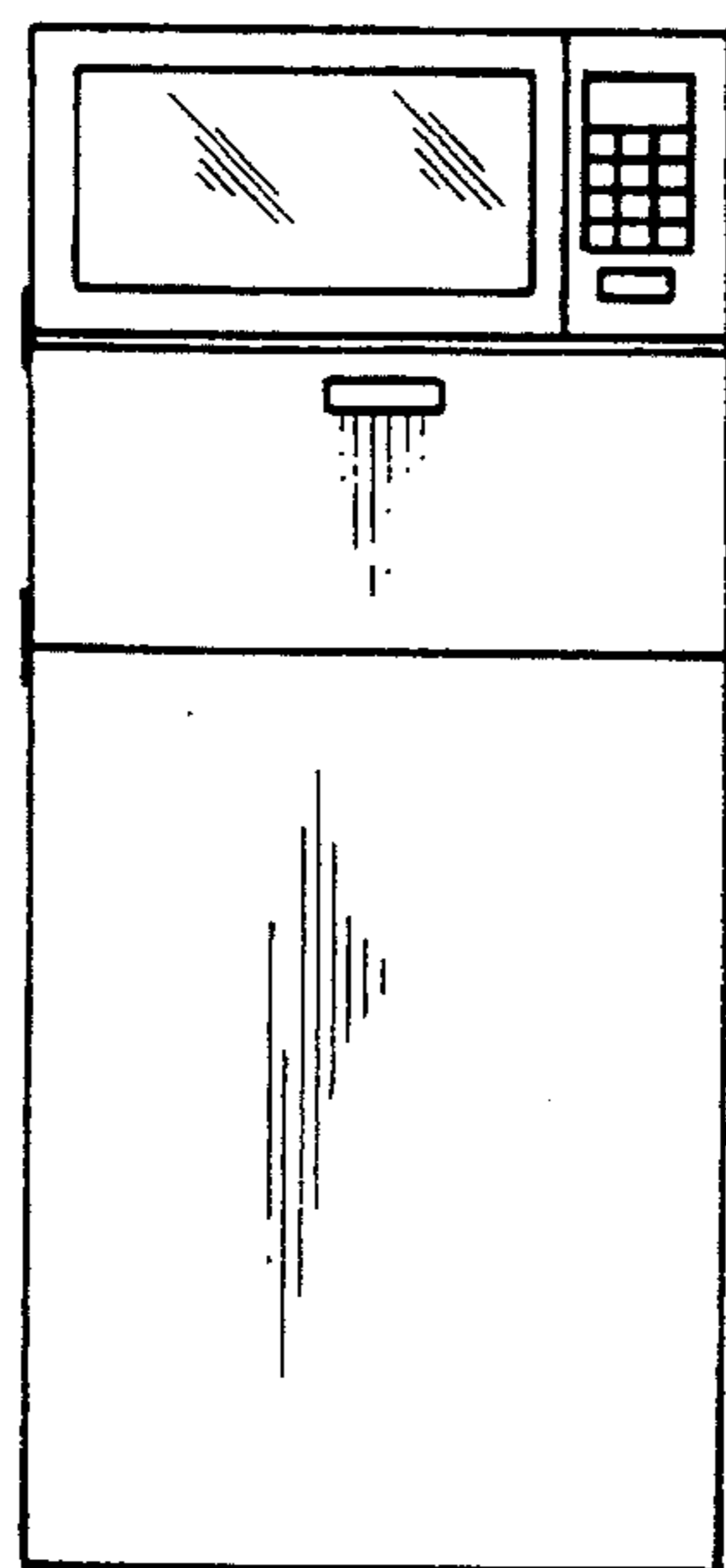




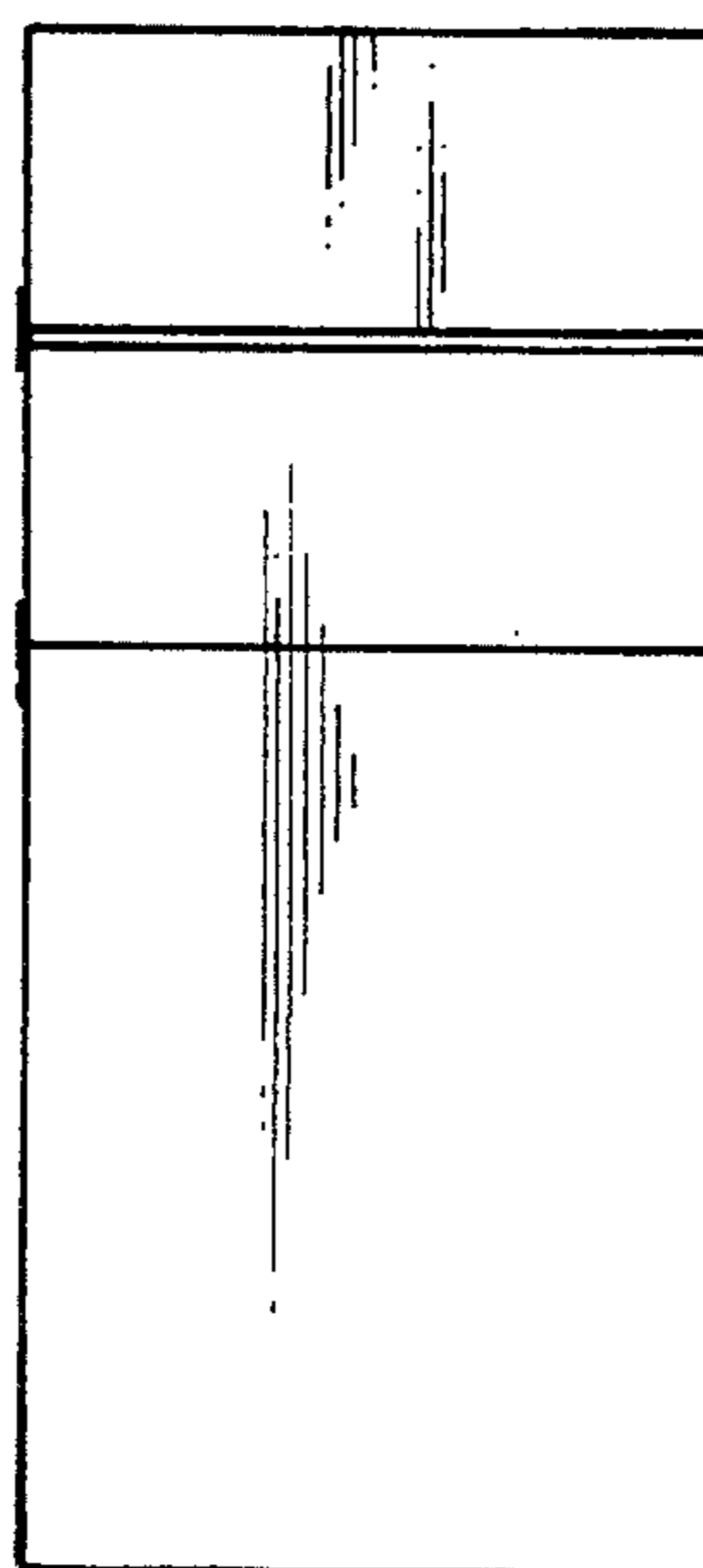
**Fig. 1**



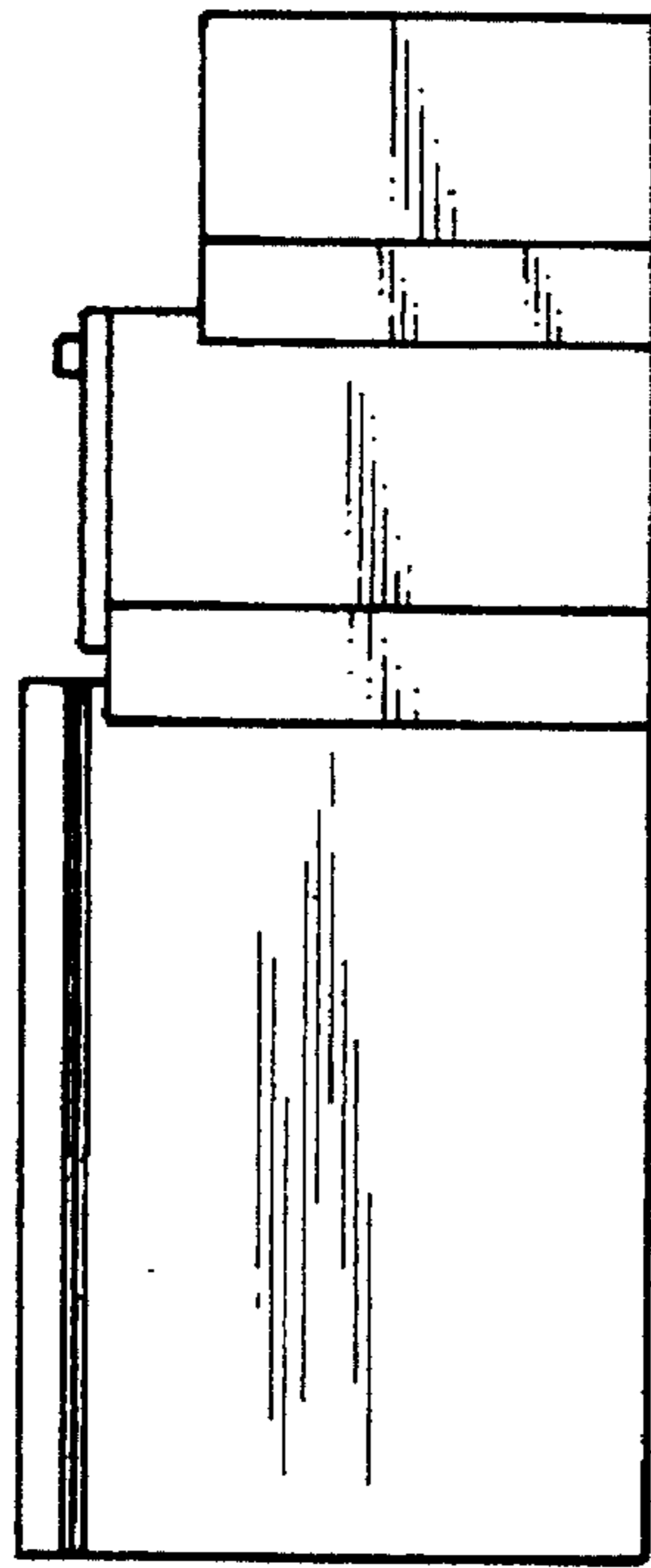
**Fig. 6**



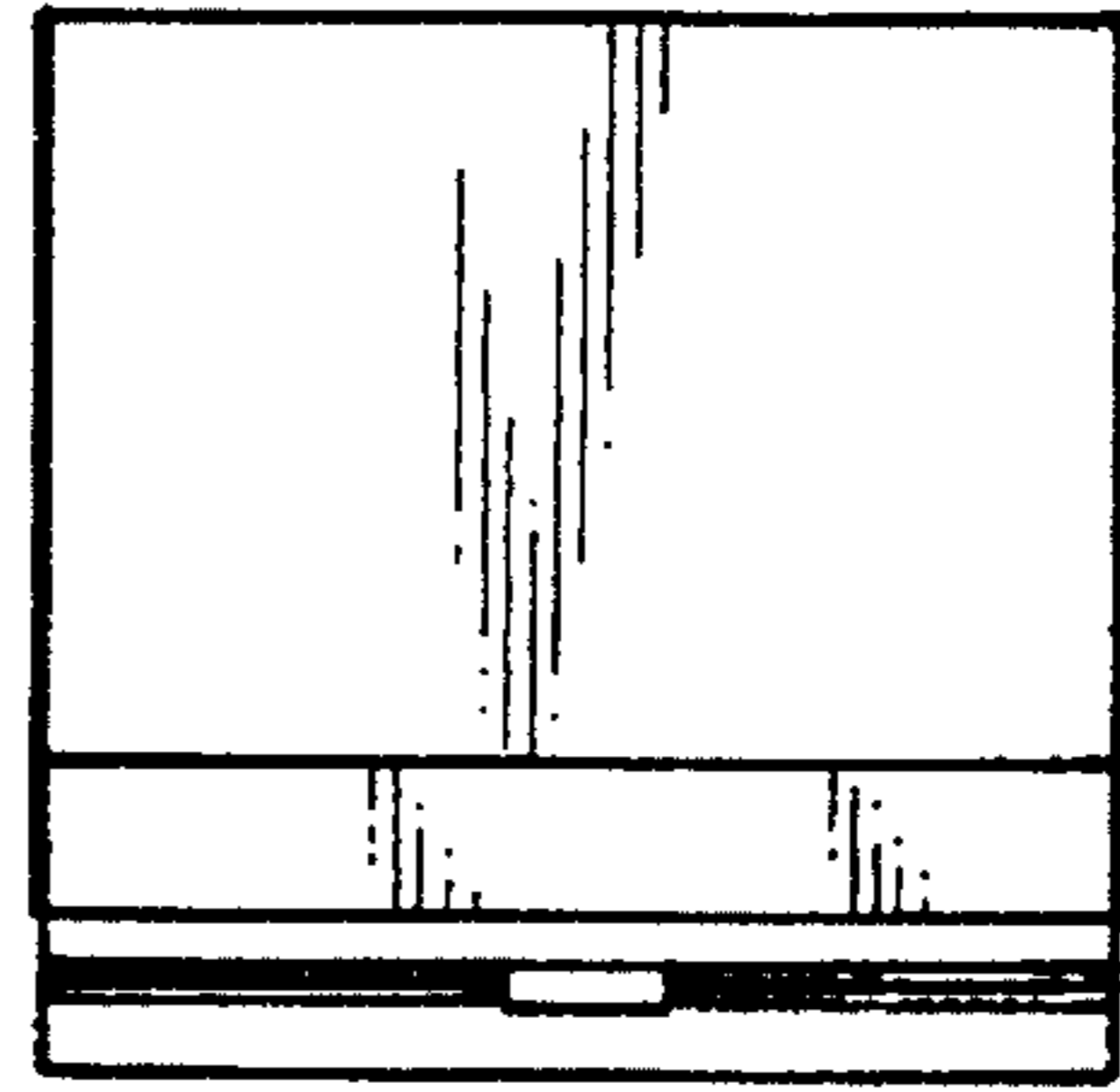
**Fig. 2**



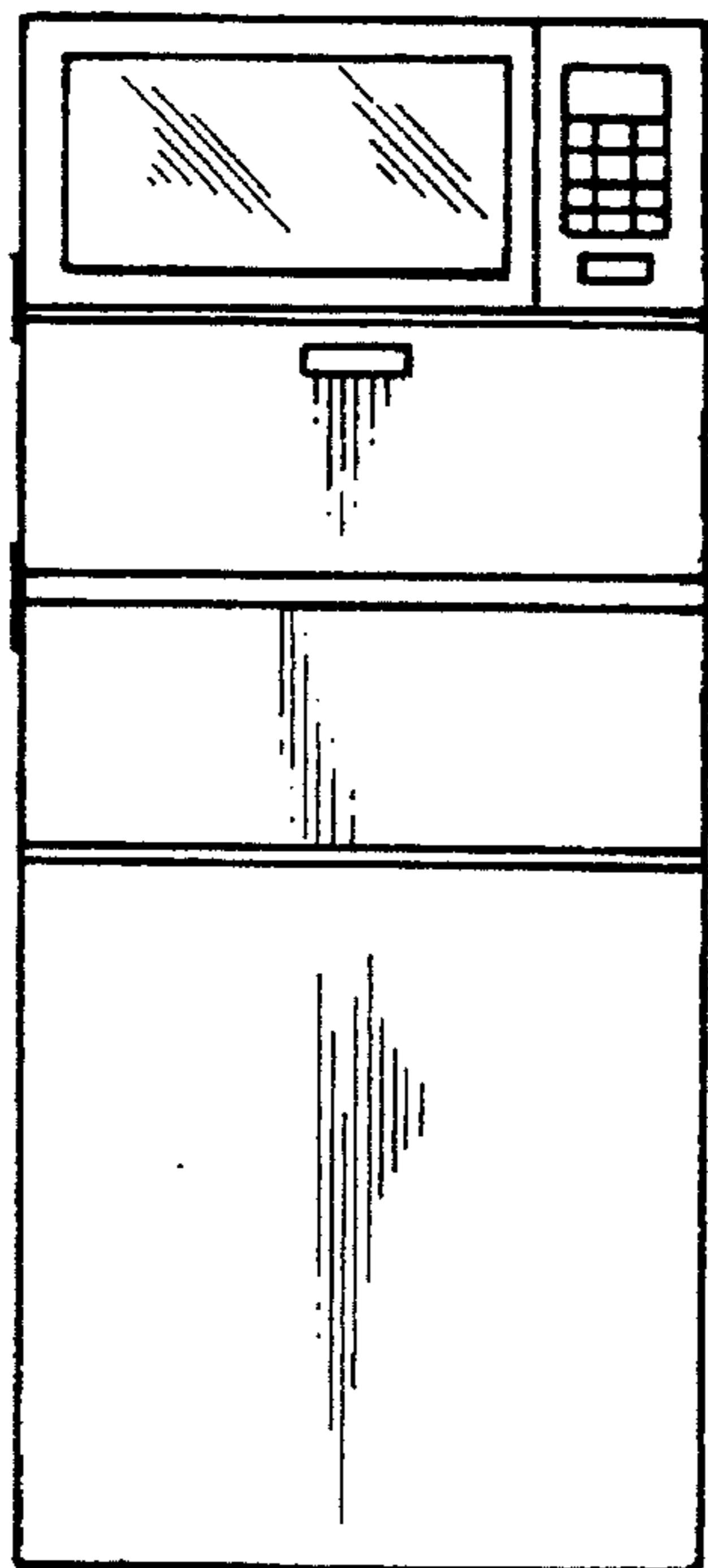
**Fig. 4**



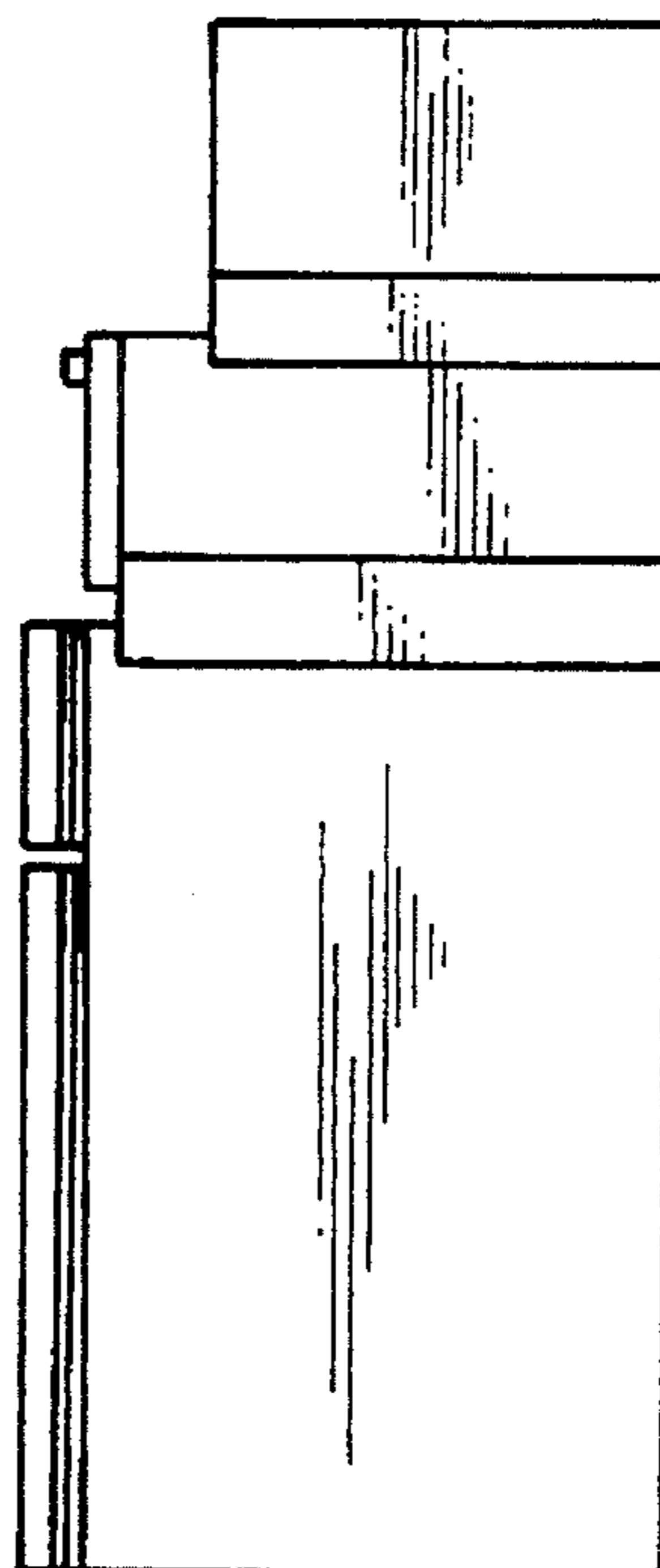
**Fig. 3**



**Fig. 5**



**Fig. 7**



**Fig. 8**