



US00D368463S

United States Patent [19]

[11] Patent Number: **Des. 368,463**

Kazenelson et al.

[45] Date of Patent: ****Apr. 2, 1996**

[54] **ACCESSORY MOUNTING FIXTURE FOR MOTOR VEHICLES**

[75] Inventors: **Kenneth A. Kazenelson**, San Juan Capistrano; **Craig H. Hertz**, Danville; **Fasha F. Mahjoor**, Rolling Hills Estate, all of Calif.

[73] Assignee: **Nebulex, Inc.**, Rolling Hills Estate, Calif.

[**] Term: **14 Years**

[21] Appl. No.: **30,524**

[22] Filed: **Nov. 1, 1994**

[52] U.S. Cl. **D12/190**

[58] Field of Search **D12/190, 197; 428/31; 248/503**

[56] **References Cited**

U.S. PATENT DOCUMENTS

D. 171,305	1/1954	Ormas, Jr.	D12/197
D. 242,786	12/1976	McAvin	D12/197 X
D. 290,620	6/1987	Elmer .	
4,599,253	7/1986	Bree	428/31 X
4,891,252	1/1990	Kaiser, Jr.	428/31
4,988,065	1/1991	Leban et al.	428/31 X
5,002,251	3/1991	Kranenberg	428/31 X
5,084,994	2/1992	Elmer .	
5,262,210	11/1993	Sellers et al.	D12/197 X

FOREIGN PATENT DOCUMENTS

0117840	9/1984	European Pat. Off.	428/31
---------	--------	-------------------------	--------

Primary Examiner—Alan P. Douglas
Assistant Examiner—Cathron B. Matta
Attorney, Agent, or Firm—Knobbe Martens Olson & Bear

[57] **CLAIM**

An ornamental design for an accessory mounting fixture for motor vehicles, as shown and described.

DESCRIPTION

FIG. 1 is a front plan view of the mounting fixture of this invention;
 FIG. 2 is a top plan view of the mounting fixture of FIG. 1;
 FIG. 3 is a right side plan view of the mounting fixture of FIG. 1;
 FIG. 4 is a rear plan view of the mounting fixture of FIG. 1;
 FIG. 5 is a bottom plan view of the mounting fixture of FIG. 1;
 FIG. 6 is a sectional view taken along plane 1—6 of FIG. 2;
 FIG. 7 is a right side plan view of the mounting fixture of FIG. 1 with a football helmet ornament attached thereto as shown in phantom;
 FIG. 8 is a front plan view of the mounting fixture of FIG. 1 with a spherical ornament attached thereto as shown in phantom; and,
 FIG. 9 is a plan view of the mounting fixture of FIG. 1, showing the fixture mounted on a motor vehicle shown in phantom lines and with a football shown in phantom lines mounted to the fixture.
 The broken line showing of a football helmet, a spherical ornament, a football, and a motor vehicle is for illustrative purposes only and forms no part of the claimed design.

1 Claim, 2 Drawing Sheets

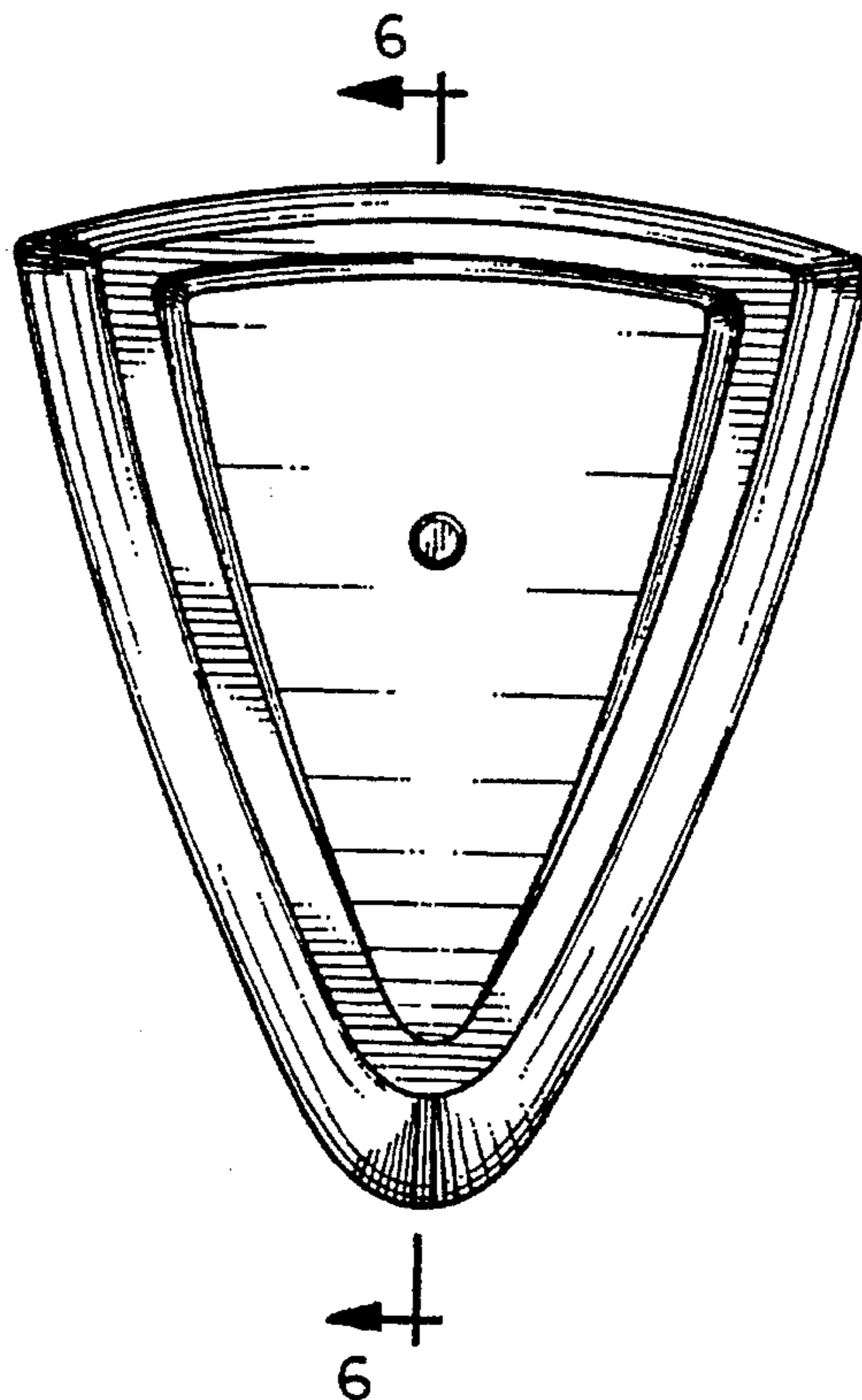

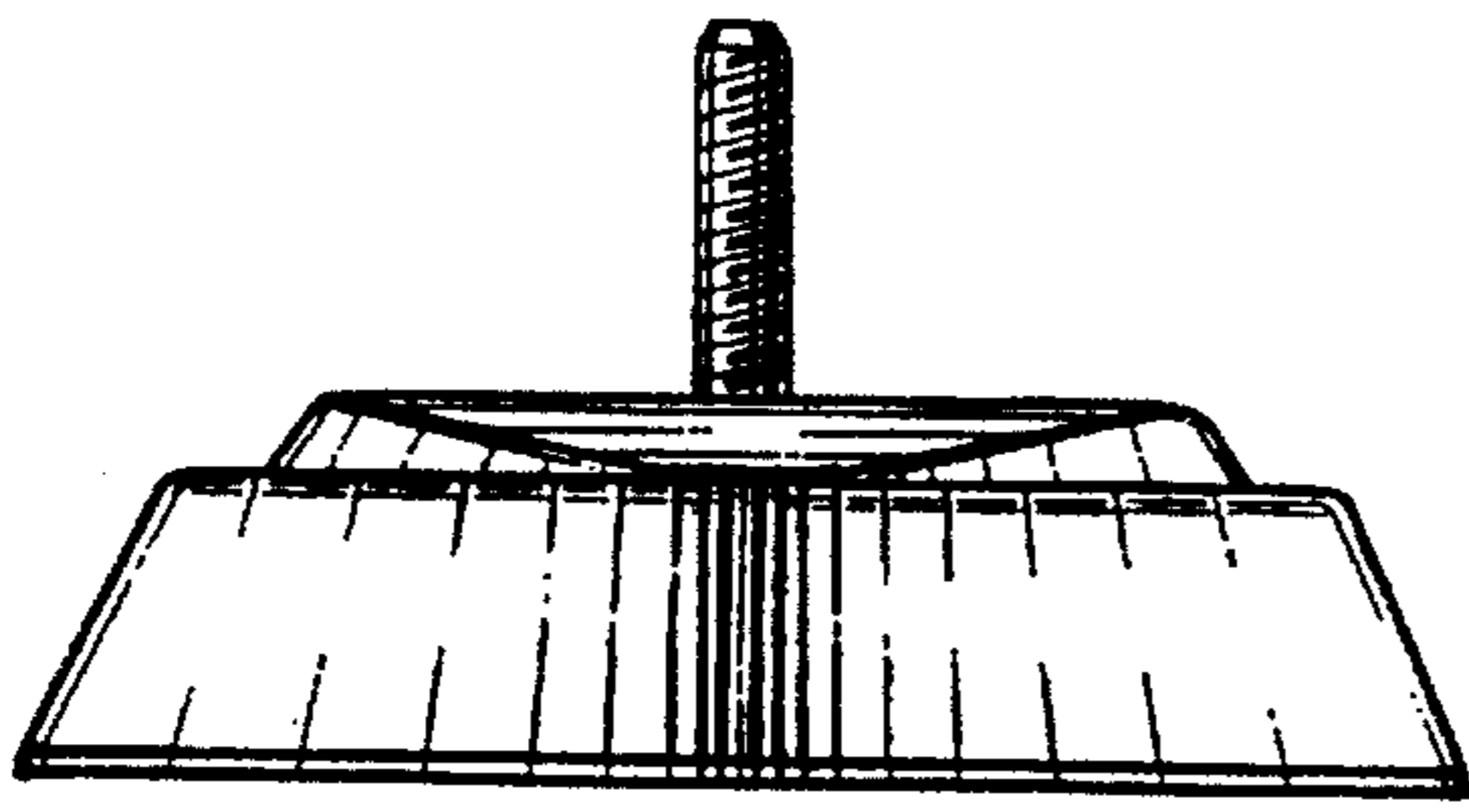

FIG. 1



FIG. 2

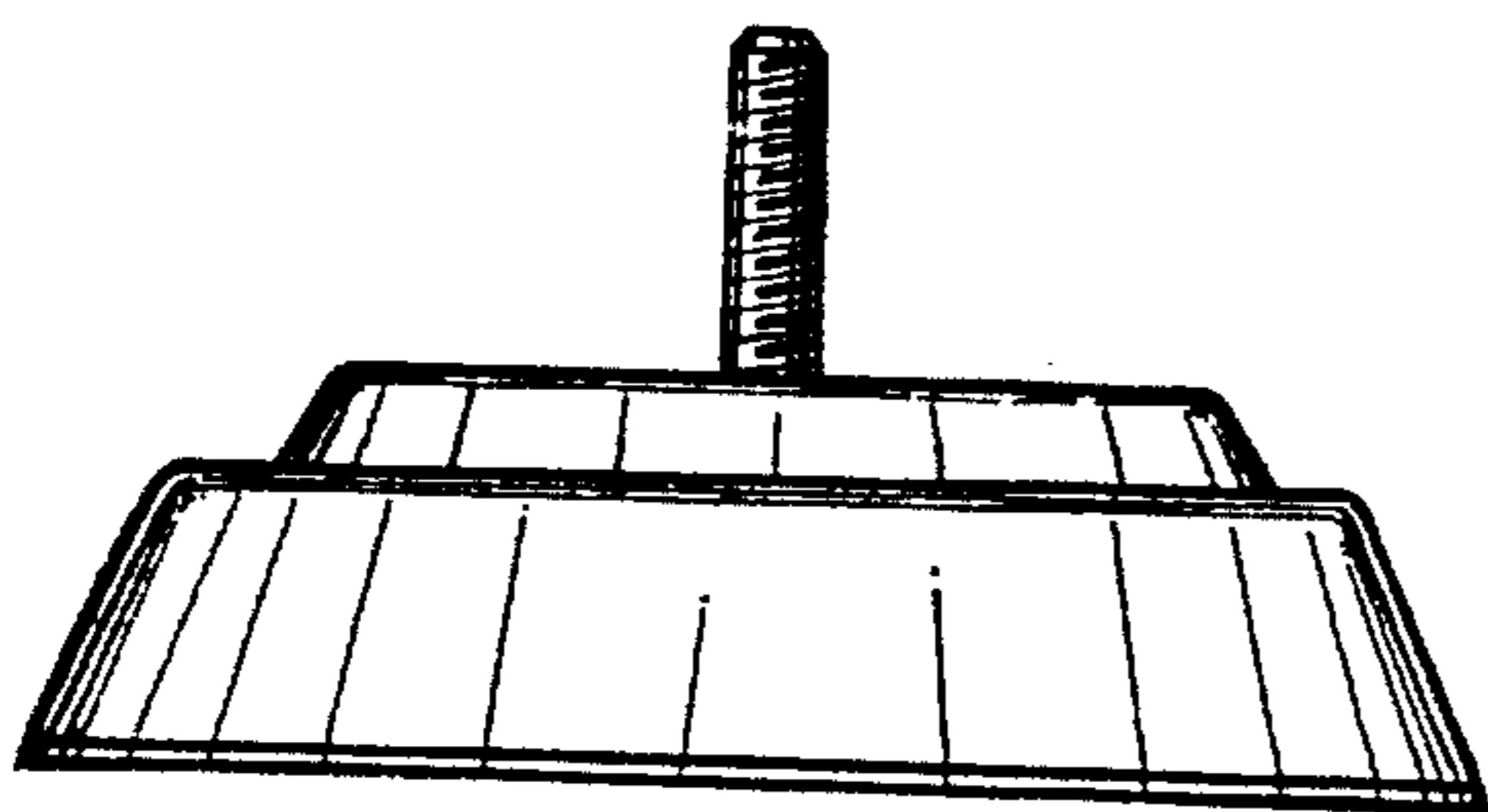
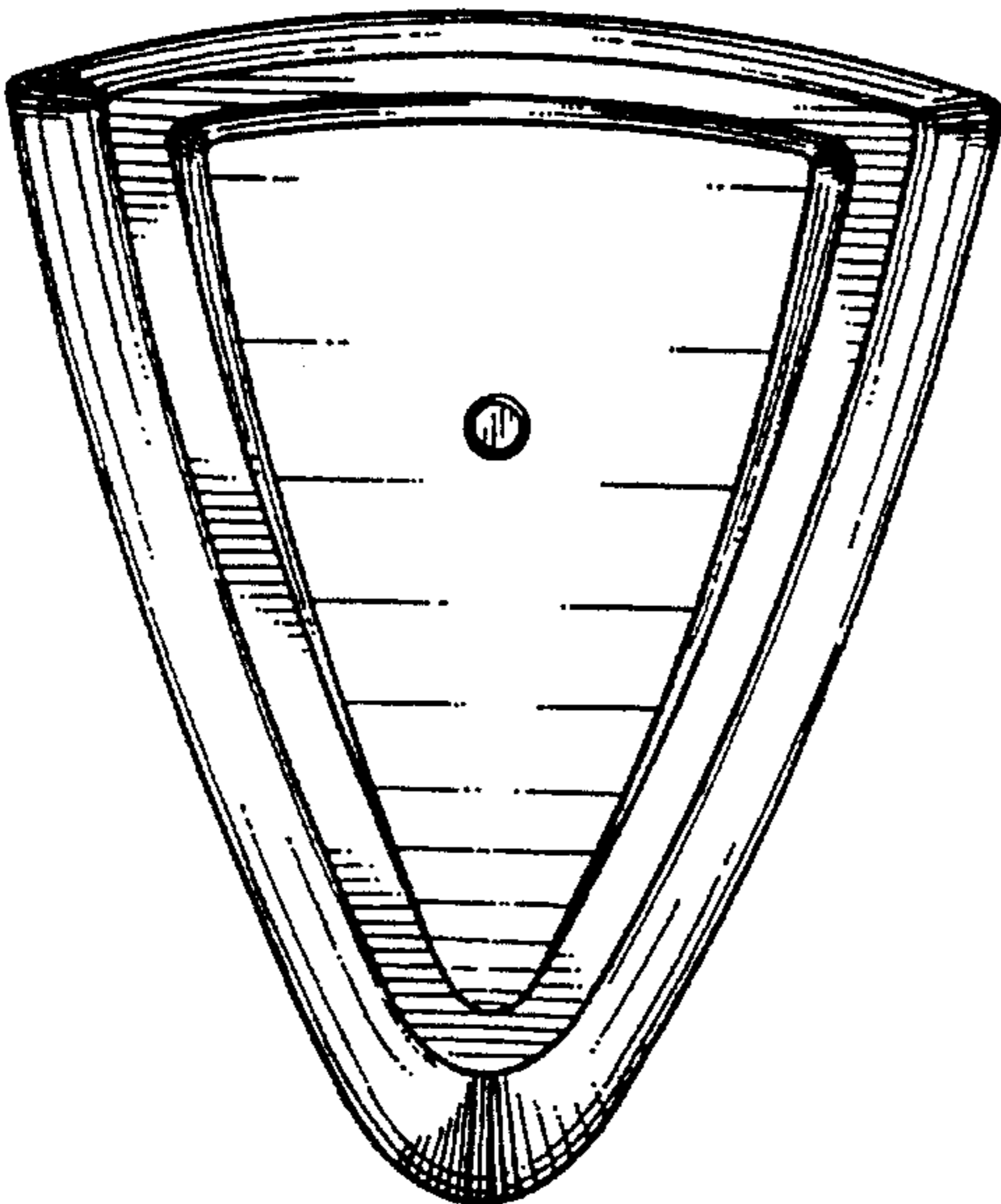

FIG. 4

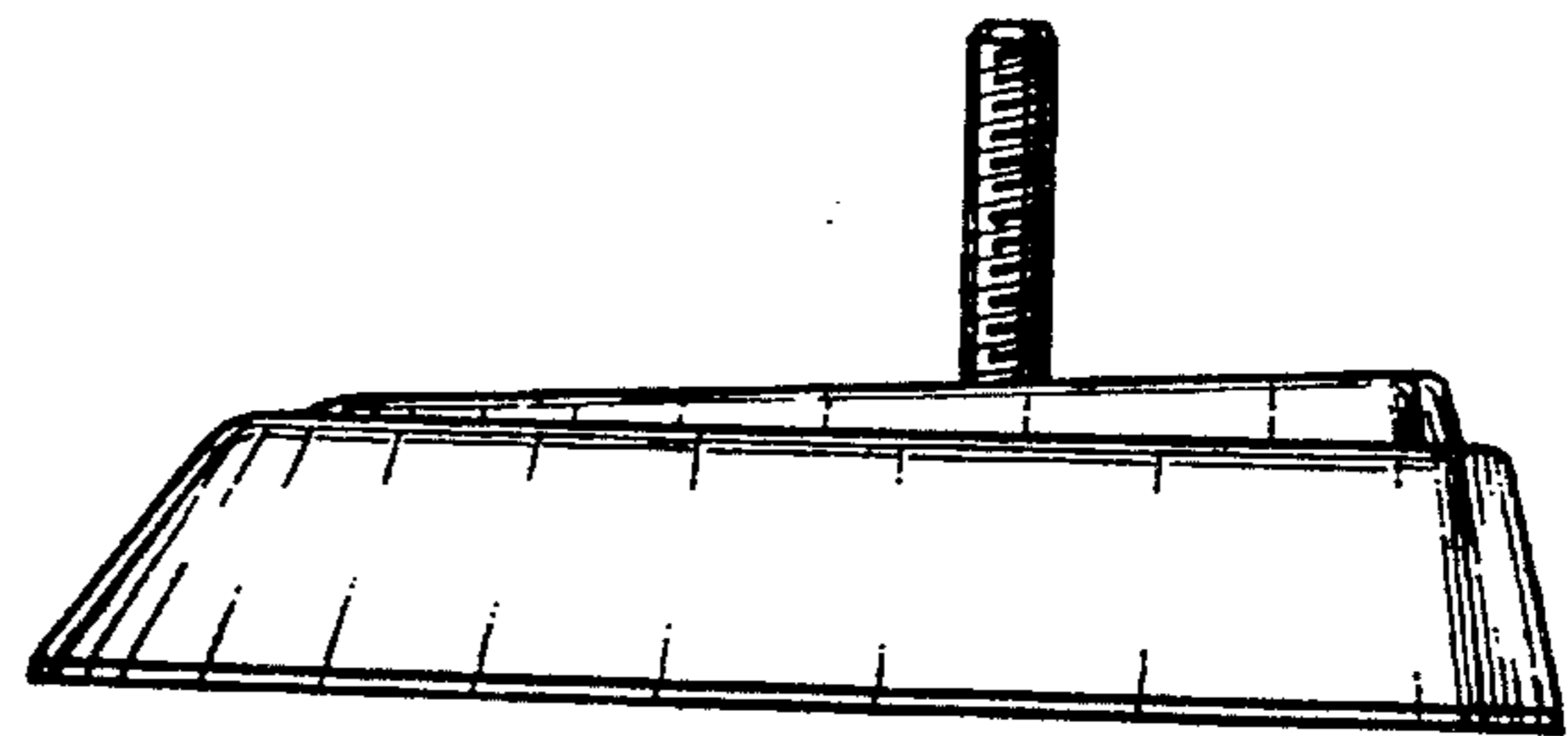

FIG. 3

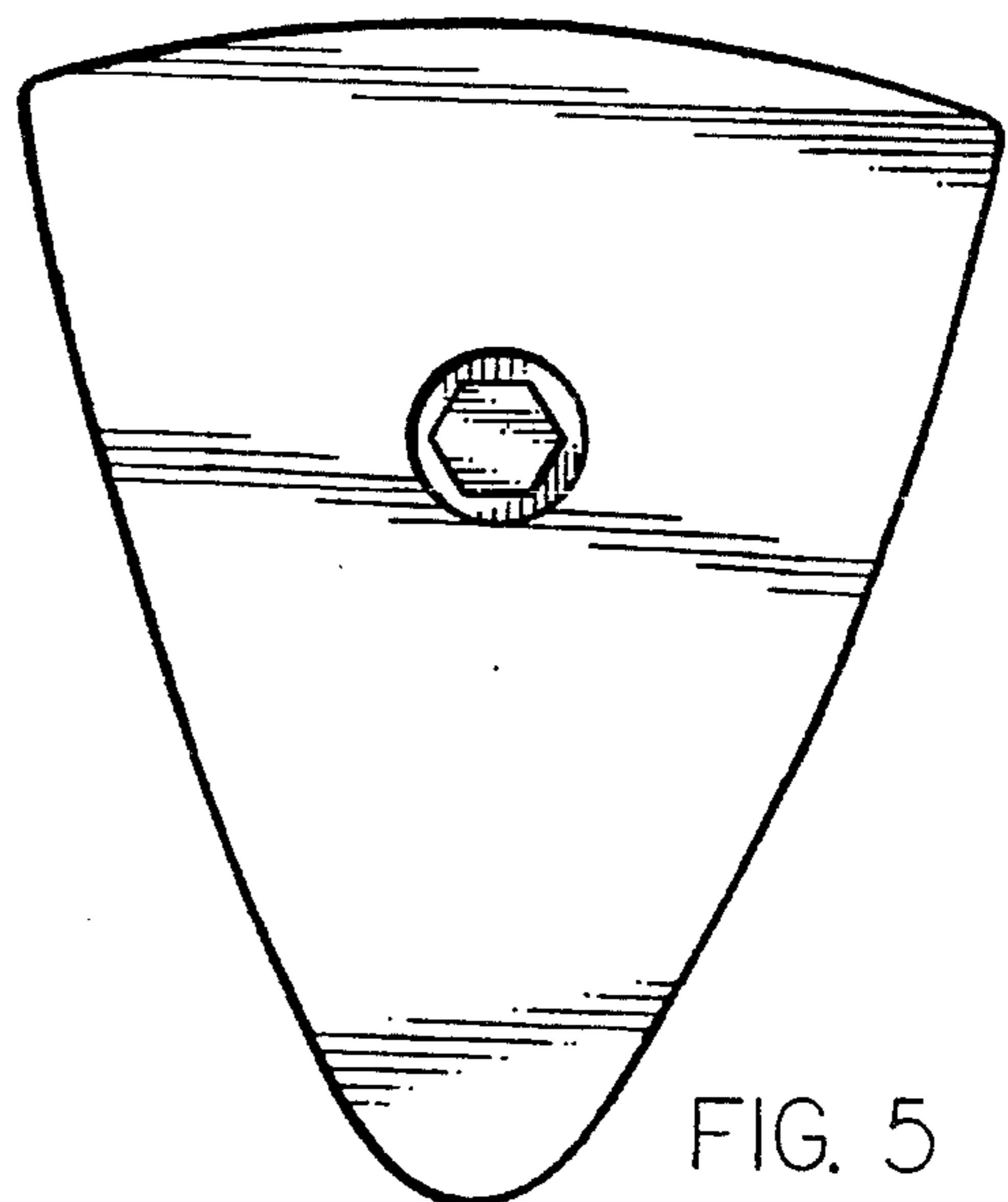

FIG. 5

FIG. 6

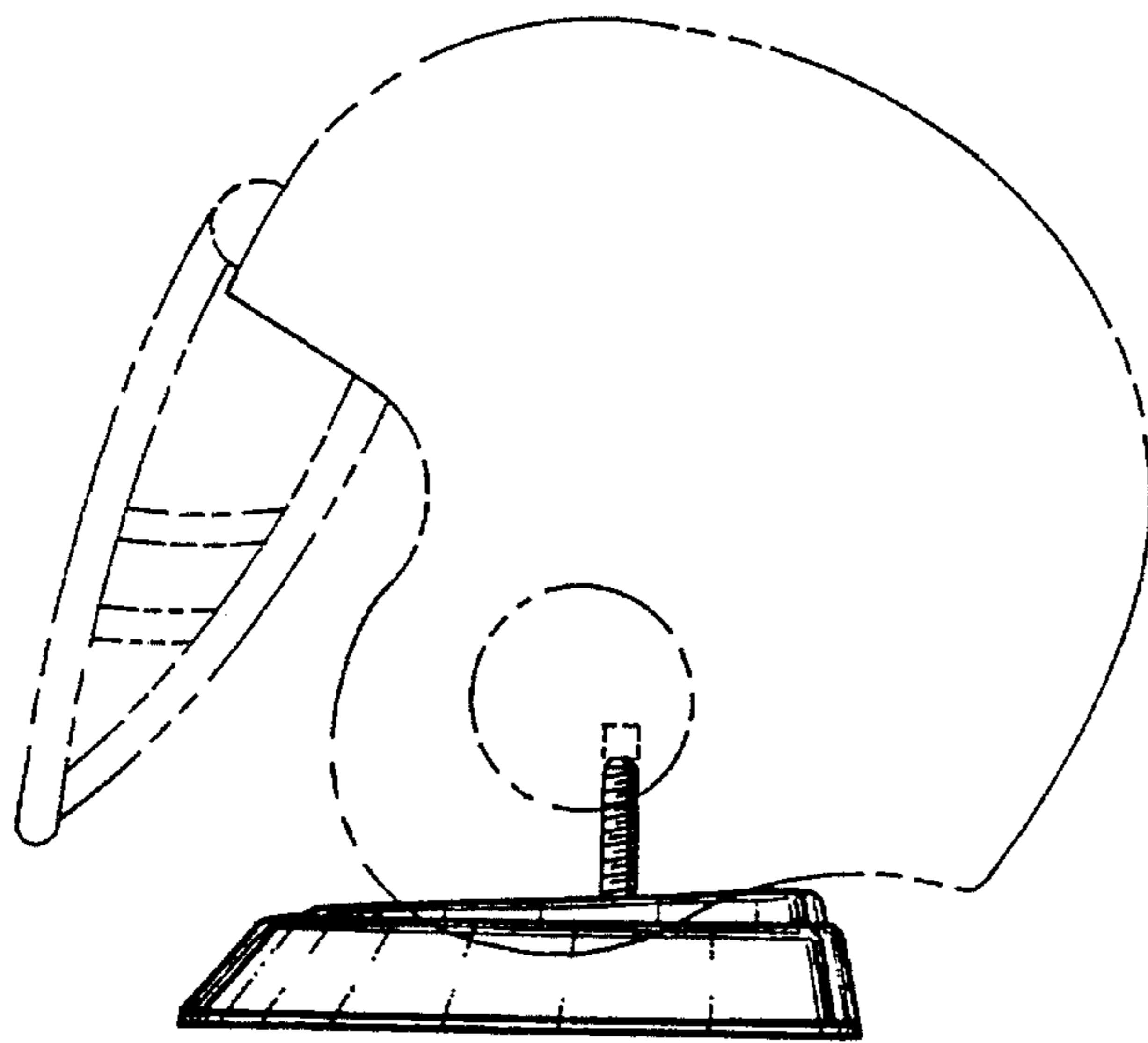
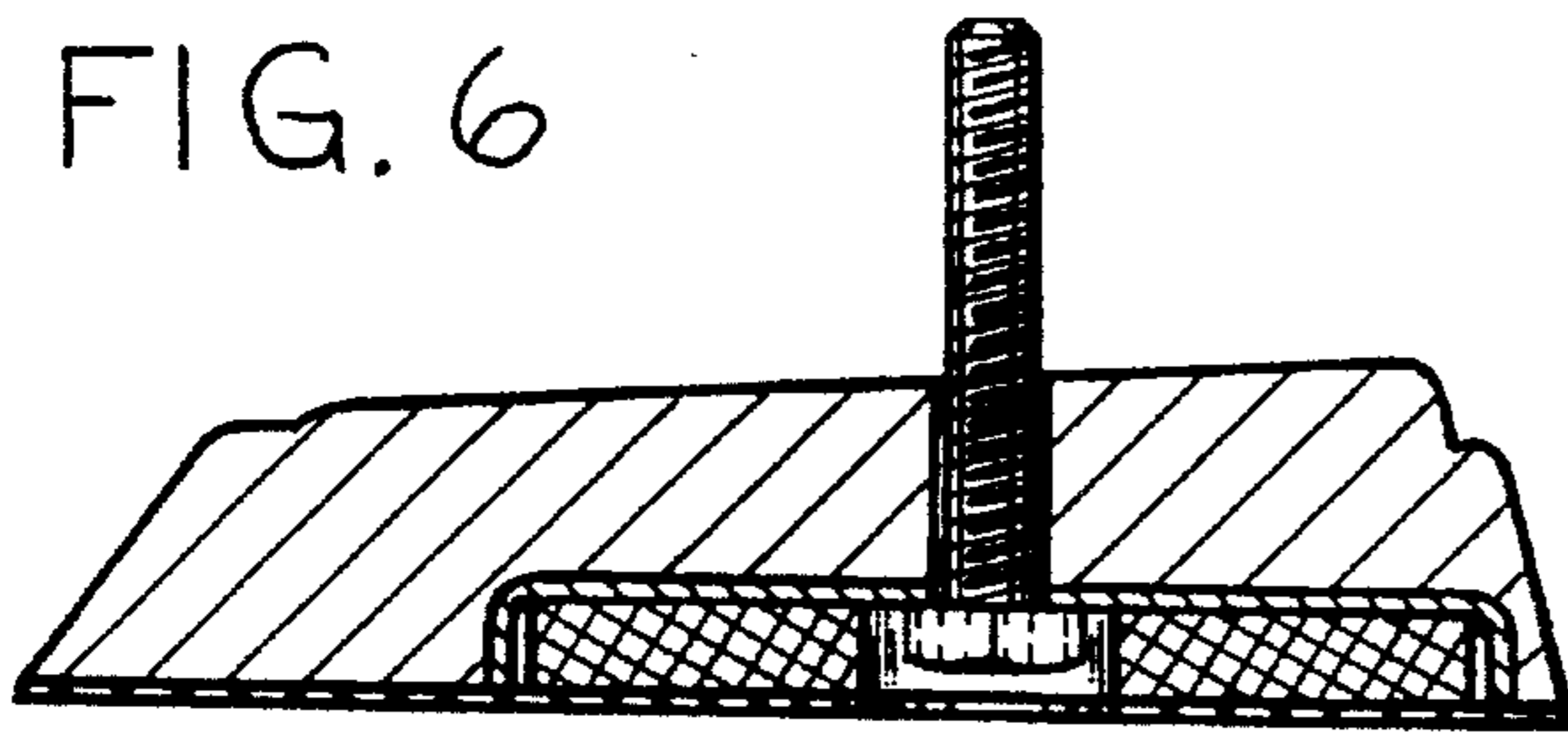

FIG. 7

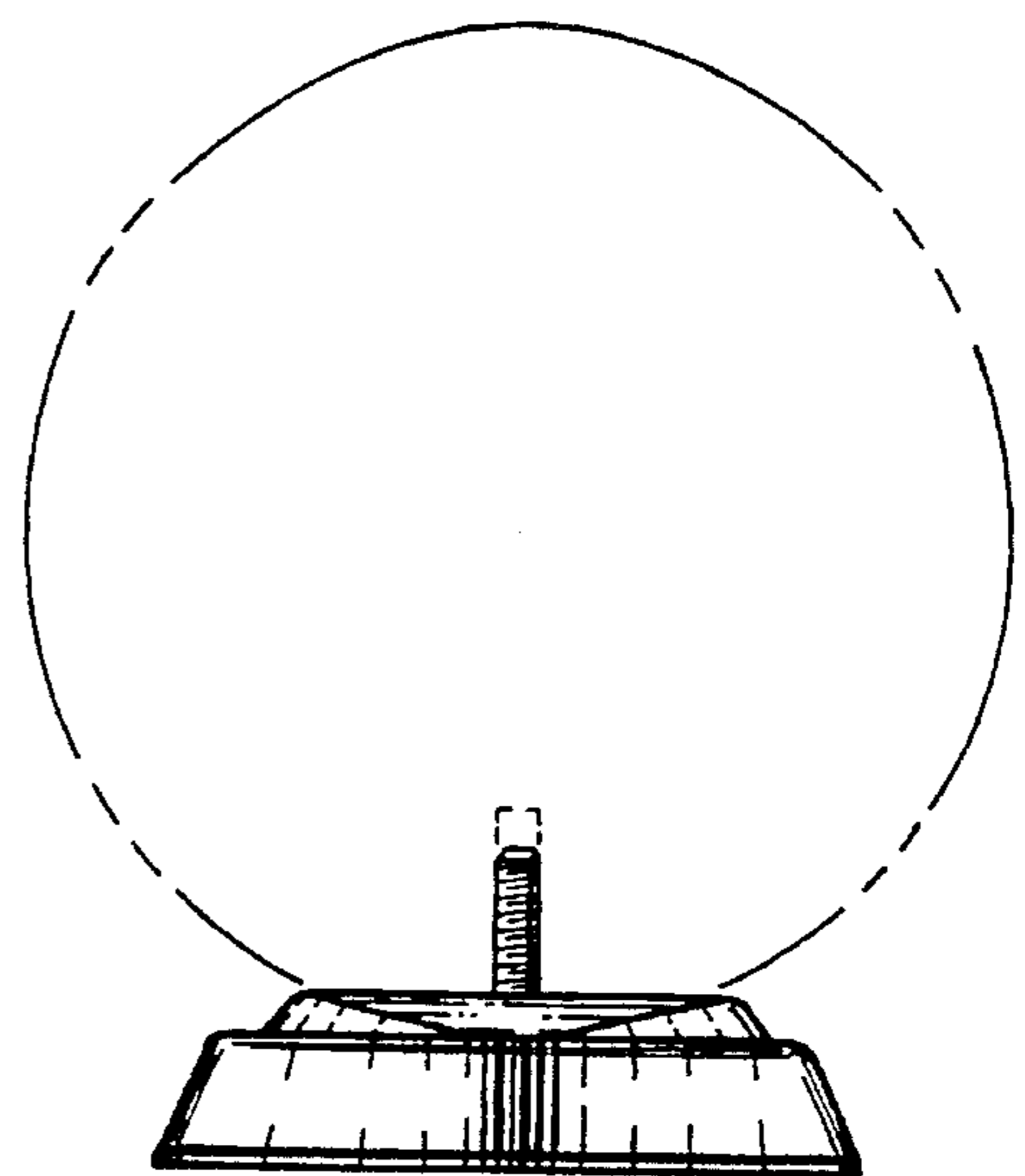

FIG. 8

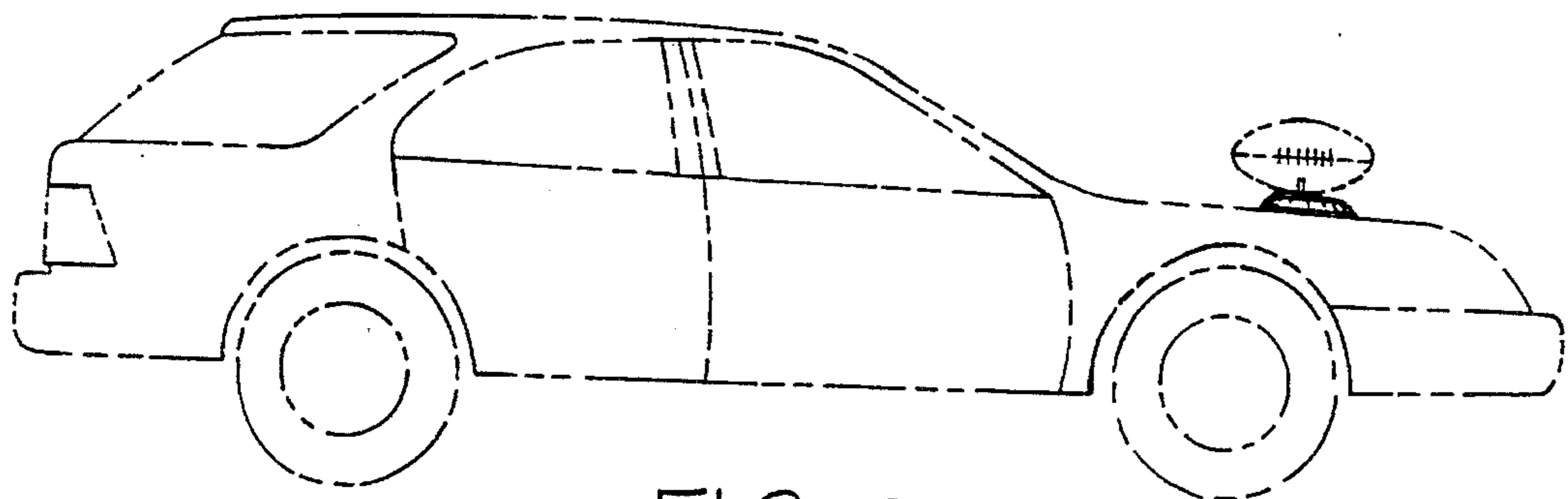

FIG. 9