



US00D368427S

United States Patent [19]

Bicknell et al.

[11] Patent Number: **Des. 368,427**

[45] Date of Patent: ***** Apr. 2, 1996**

[54] **COMBINED ROLL-ON DISPENSER BOTTLE AND CAP**

[75] Inventors: **David Bicknell**, Cambridge; **Martin C. Bunce**; **John Lamb**, both of London, all of United Kingdom

[73] Assignee: **Chesebrough-Pond's USA Co., Division of Conopco, Inc.**, Greenwich, Conn.

[*] Notice: The portion of the term of this patent subsequent to Mar. 26, 2010, has been disclaimed.

[**] Term: **14 Years**

[21] Appl. No.: **26,698**

[22] Filed: **Aug. 3, 1994**

[30] **Foreign Application Priority Data**

Feb. 3, 1994 [GB] United Kingdom 2036770

[52] U.S. Cl. **D9/338**; D9/529; D9/539

[58] Field of Search D9/338, 530, 529, D9/539; 215/1 R, 1 C; 401/209, 213, 214, 215

[56] **References Cited**

U.S. PATENT DOCUMENTS

D. 230,568 5/1974 Byrne D9/529 X

D. 317,118	5/1991	Crawford	D9/338
D. 330,860	11/1992	Gatrost	D9/338 X
D. 333,780	3/1993	Jones et al.	D9/338
D. 346,112	4/1994	Alcindor	D9/338
4,221,495	9/1980	Braun et al.	401/213
4,588,320	5/1986	Weinstein	401/213

Primary Examiner—Ted Shooman
Assistant Examiner—Cheri Cohen
Attorney, Agent, or Firm—Milton L. Honig

[57] **CLAIM**

The ornamental design for a combined roll-on dispenser bottle and cap, as shown and described.

DESCRIPTION

FIG. 1 is a reduced perspective view of a combined roll-on dispenser bottle and cap showing our new design;

FIG. 2 is a rear elevational view thereof, the front view being the same;

FIG. 3 is a bottom plan view thereof;

FIG. 4 is a side elevational view from the right hand side thereof, the left hand side view being the same;

FIG. 5 is a front elevational view thereof, with the cap removed for clarity of illustration; and,

FIG. 6 is a top plan view of FIG. 1.

1 Claim, 2 Drawing Sheets

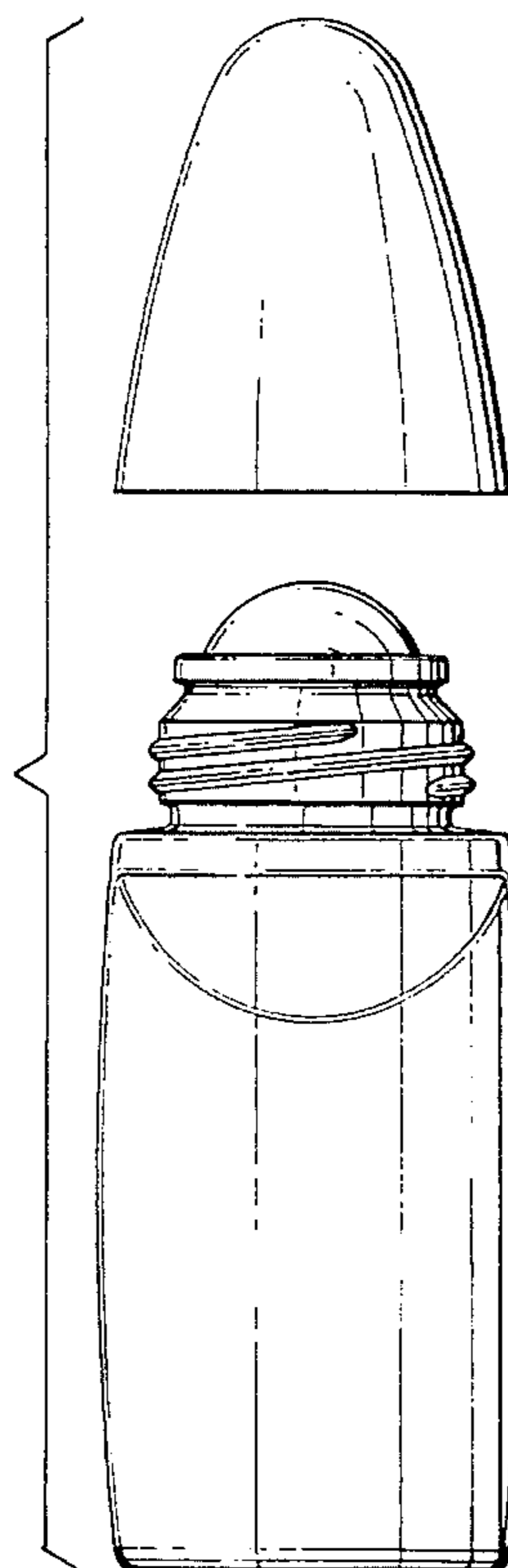
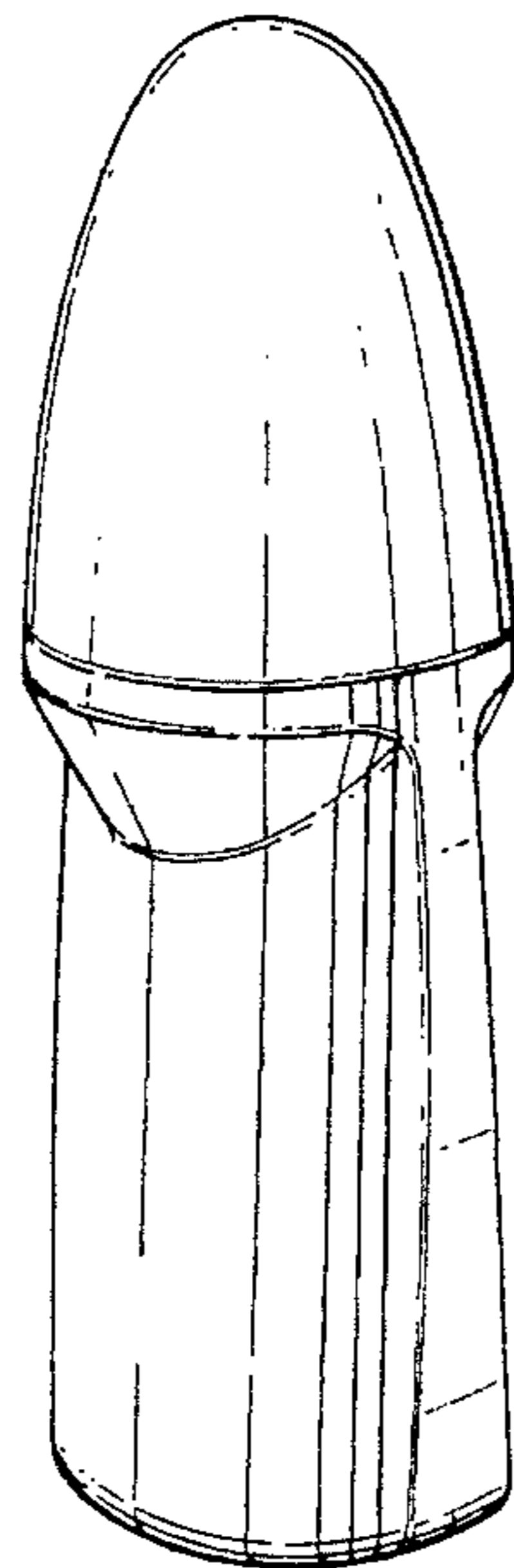

Fig. 1.

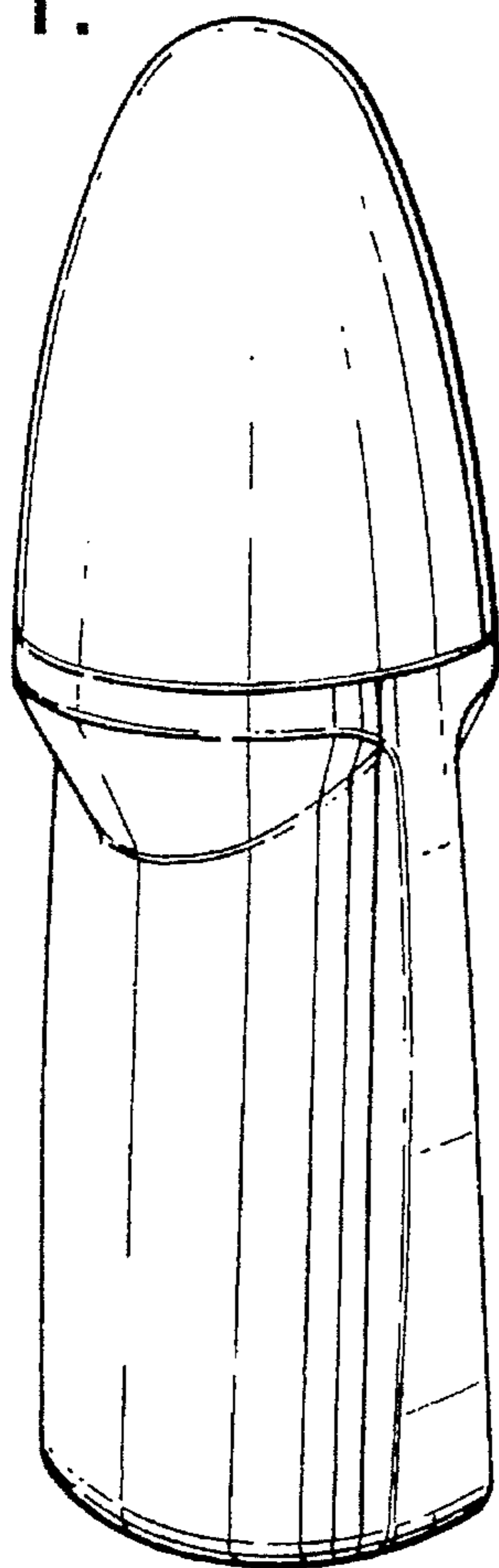

Fig. 2.

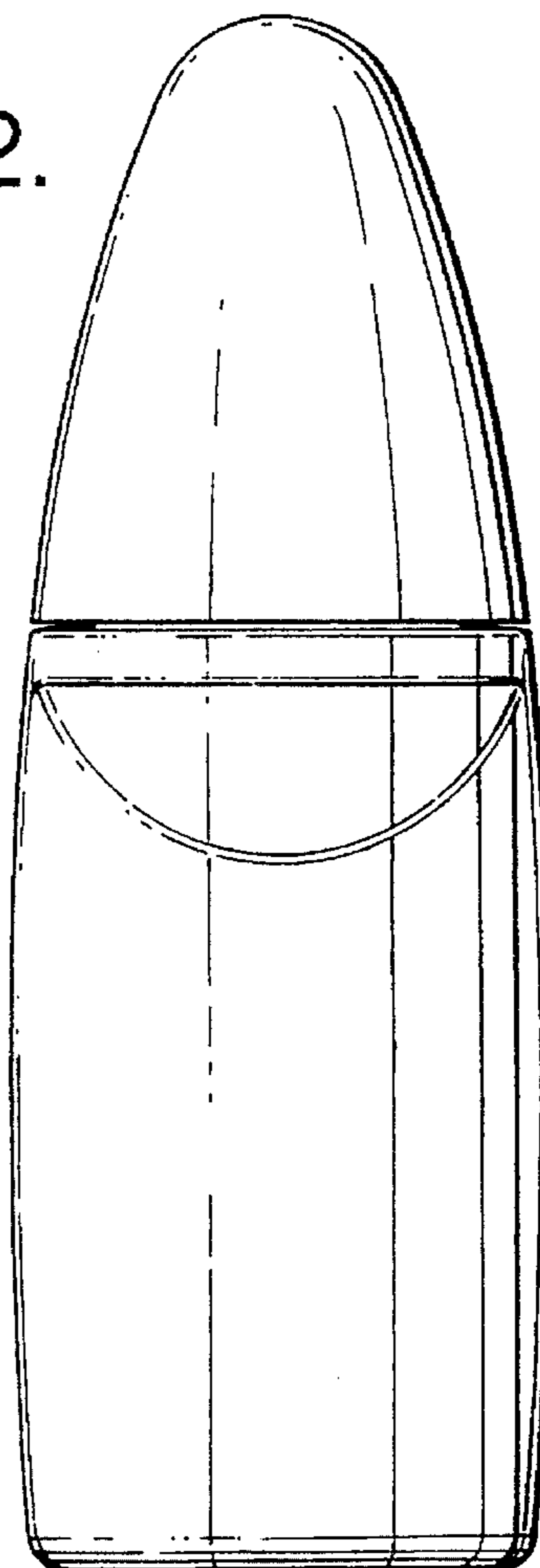
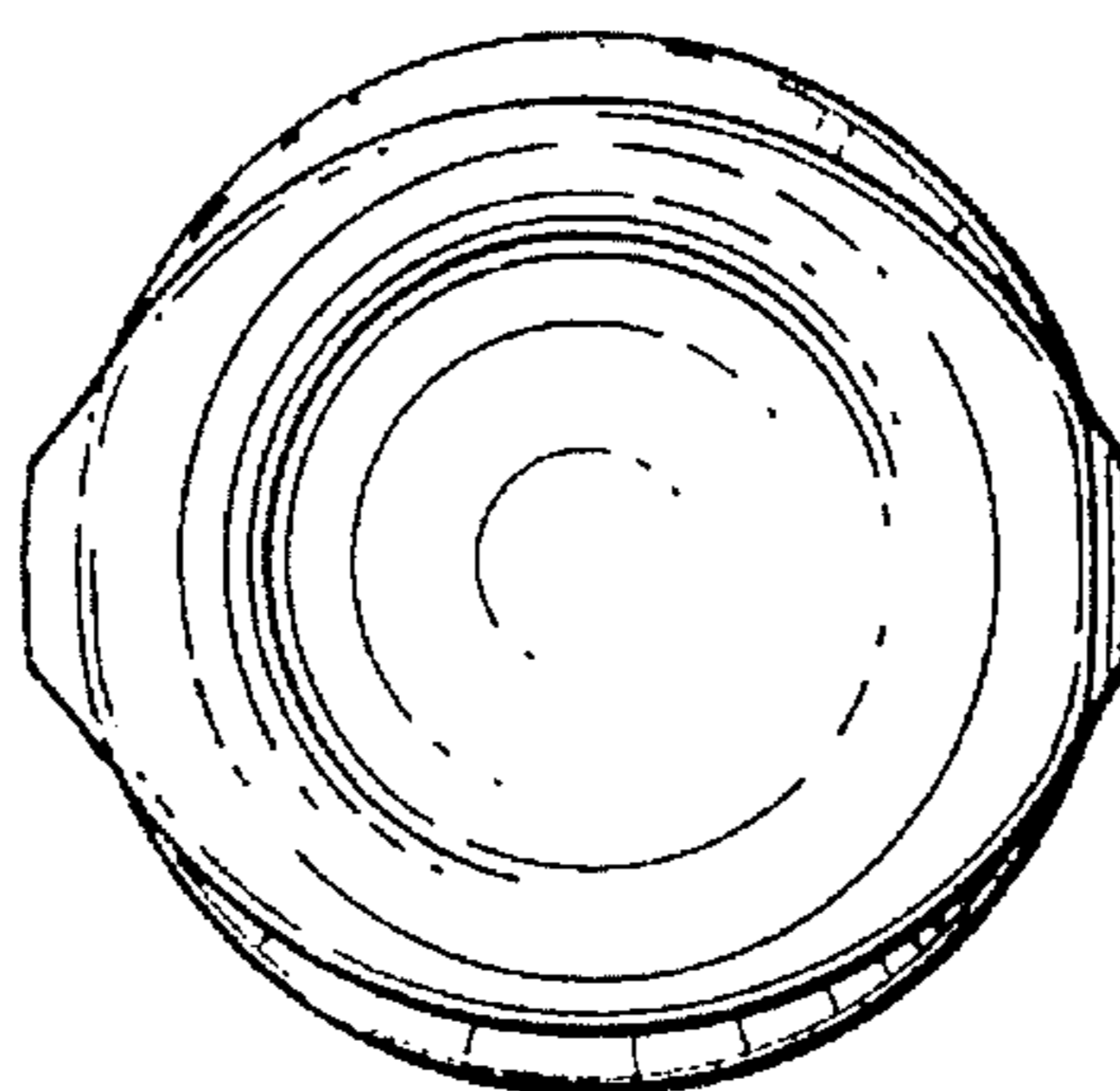

Fig. 3.



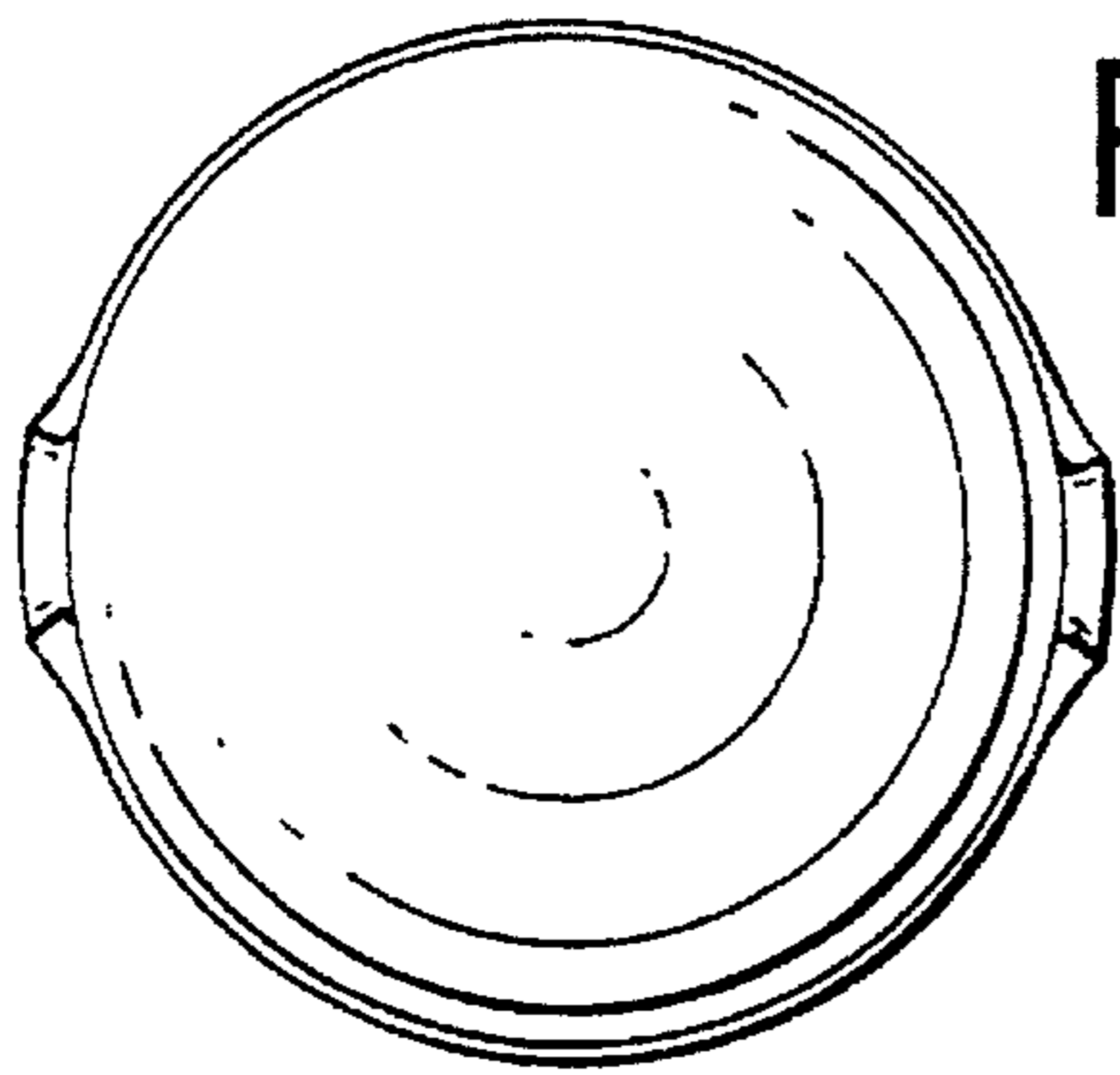

Fig.6.

Fig.5.

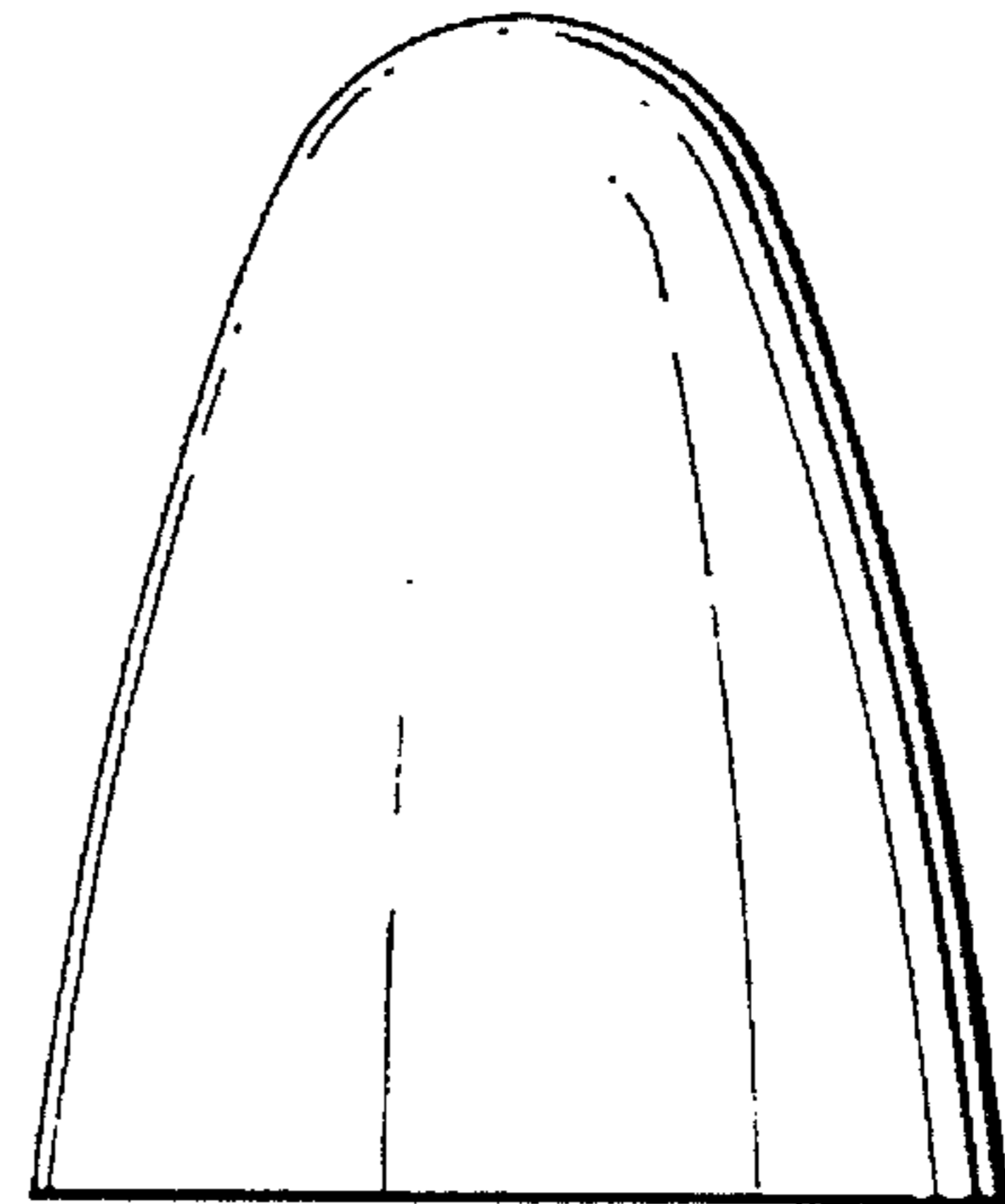

Fig.4.

