



US00D368392S

United States Patent [19]

[11] Patent Number: **Des. 368,392**

Brunner et al.

[45] Date of Patent: ****Apr. 2, 1996**

[54] **NIGHT STAND**

[75] Inventors: **Merlin A. Brunner**, Appleton; **Harvey J. Draheim**, Weyauwega, both of Wis.

[73] Assignee: **Simmons Juvenile Products Company, Inc.**, New London, Wis.

[**] Term: **14 Years**

[21] Appl. No.: **23,452**

[22] Filed: **May 25, 1994**

[52] U.S. Cl. **D6/436**

[58] Field of Search D6/396, 432-448,
D6/449, 454; 312/233, 352

[56] **References Cited**

PUBLICATIONS

"The Moosehead Collection", Mar. 1973, p. 21, Item No. 408, Night Stand.

"Ikea" Catalog, p. 166, Item No. 3, Bedside Table.

"Ethan Allen Treasury", 1988, p. 142, Item No. 19-5306, Night Table.

"Sterling House Collections", Sterlingworth Corp., May 1973, Item No. 5085, Night Stand.

Simmons Juvenile Products Company, Inc. 1990 Catalog: Nite Stand No. 4702.

Primary Examiner—Alan P. Douglas
Assistant Examiner—Cathron B. Matta
Attorney, Agent, or Firm—Hoffmann & Baron

[57] **CLAIM**

The ornamental design for a night stand, as shown and described.

DESCRIPTION

FIG. 1 is a front perspective view of a night stand showing our new design;

FIG. 2 is a top plan view thereof;

FIG. 3 is a front elevation view thereof;

FIG. 4 is a side elevation view thereof, the opposite side being a mirror image thereof;

FIG. 5 is a rear elevation view thereof;

FIG. 6 is a bottom plan view thereof;

FIG. 7 is an enlarged sectional view taken along line 7—7 of FIG. 3; and,

FIG. 8 is an enlarged sectional view taken along line 8—8 of FIG. 3.

1 Claim, 5 Drawing Sheets

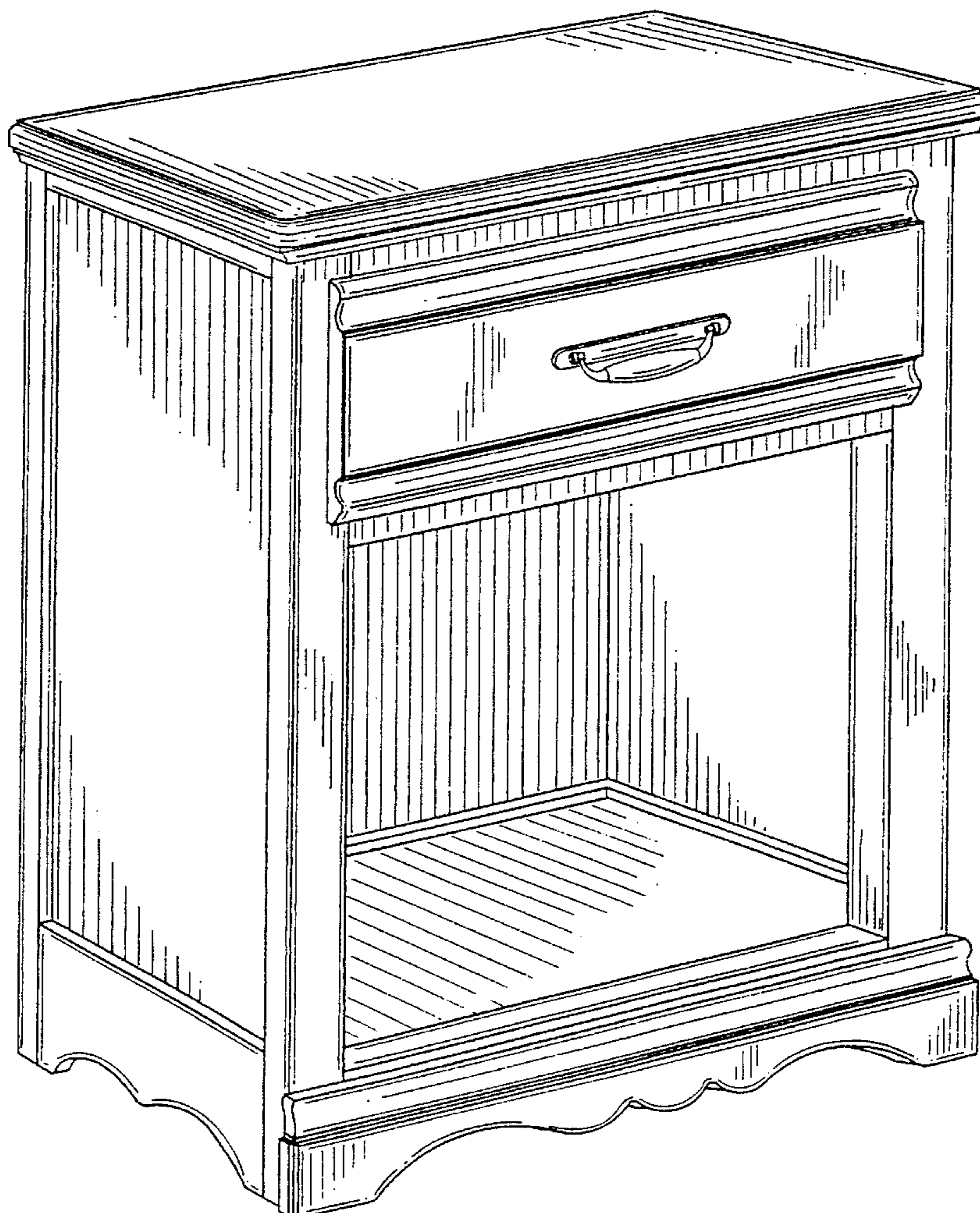

FIG-1

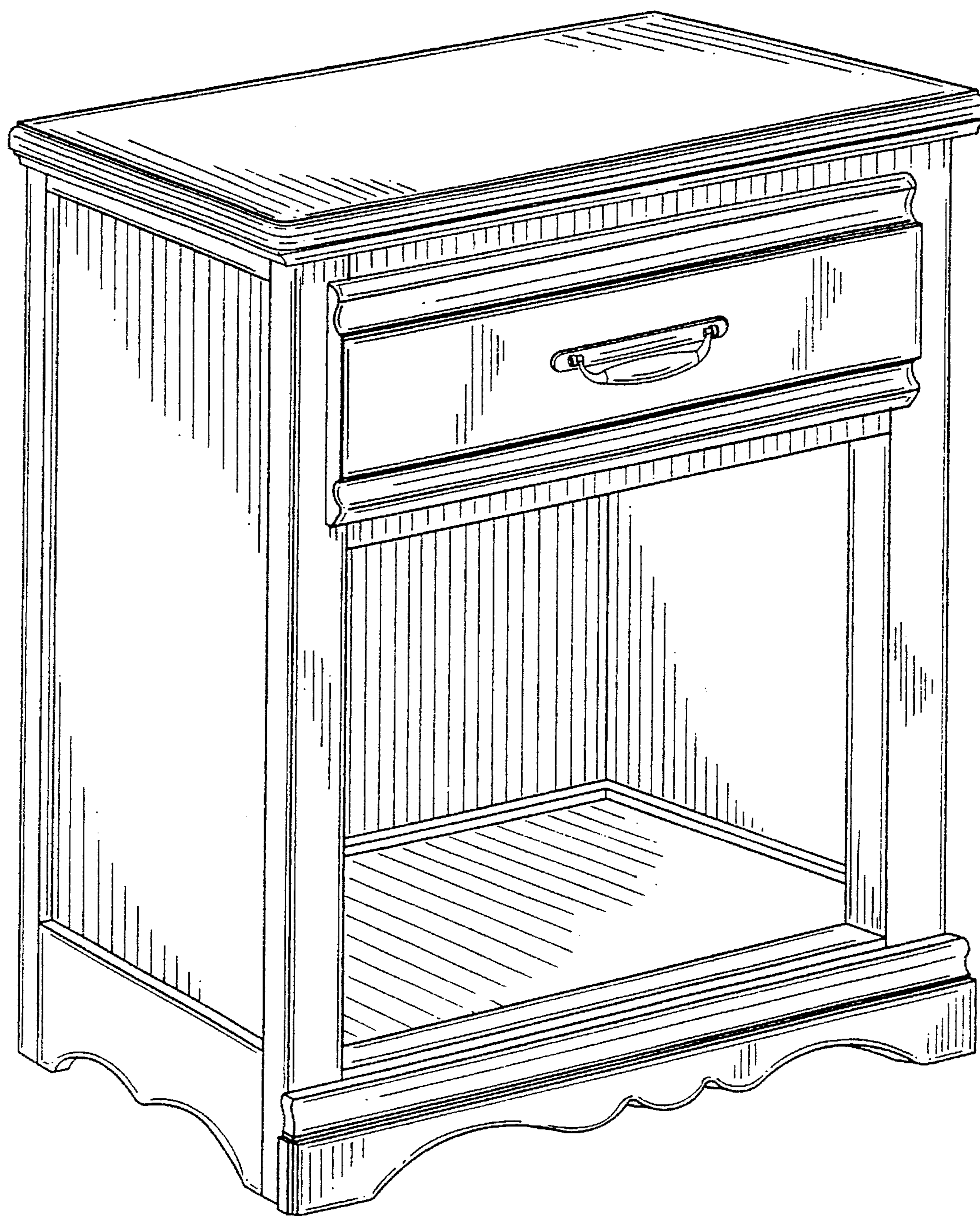

FIG-2

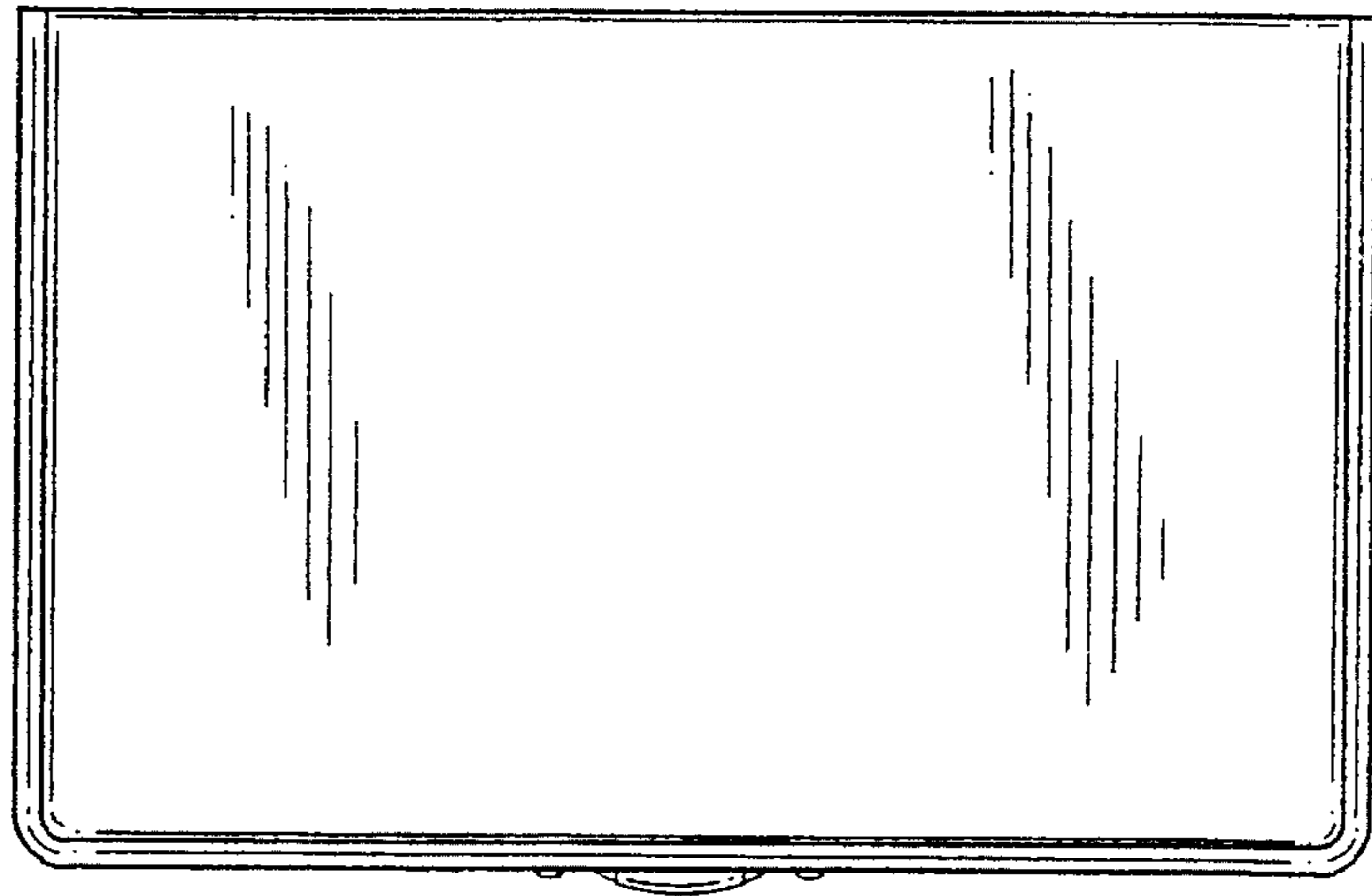

FIG-3

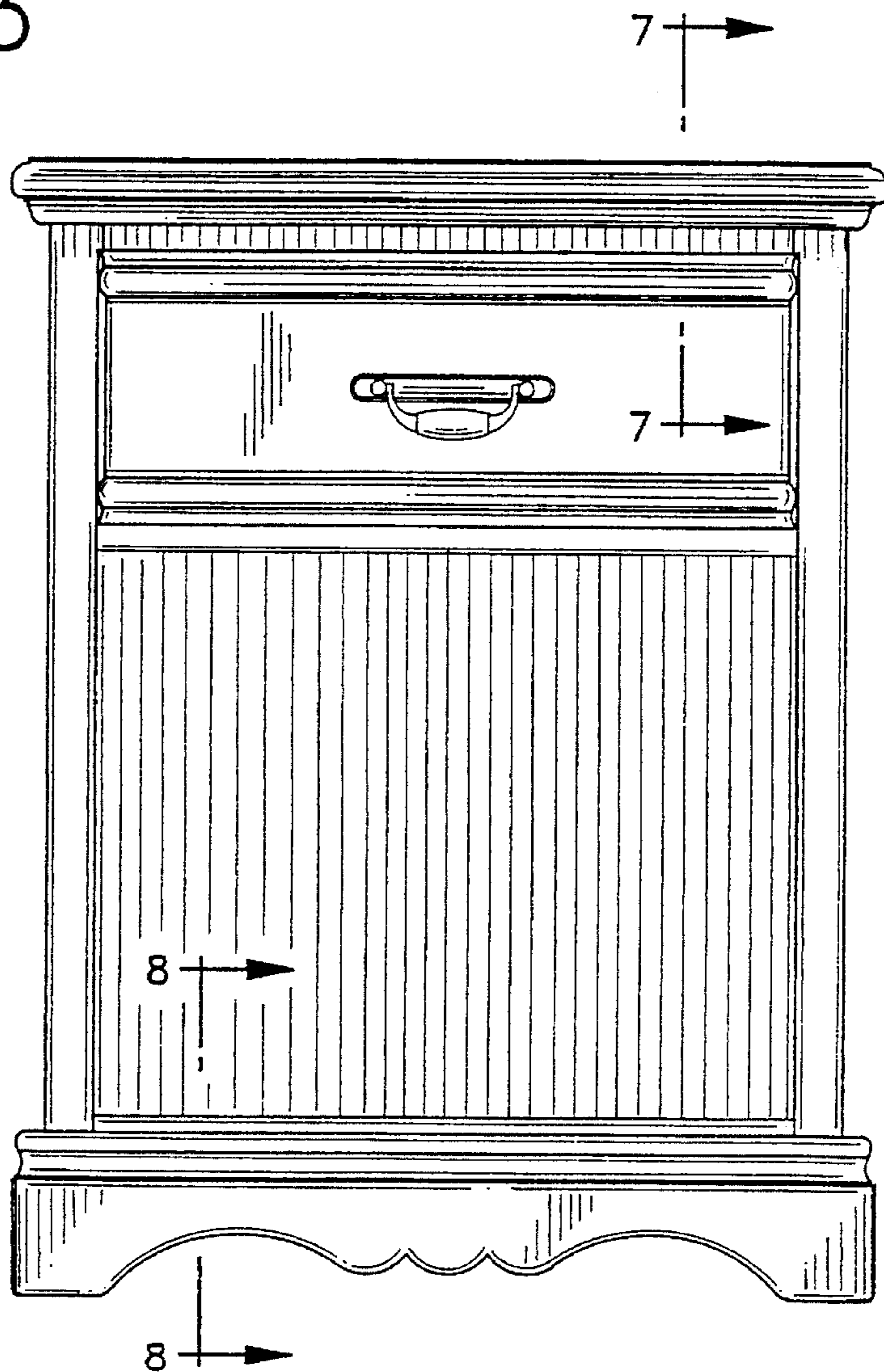

FIG-4

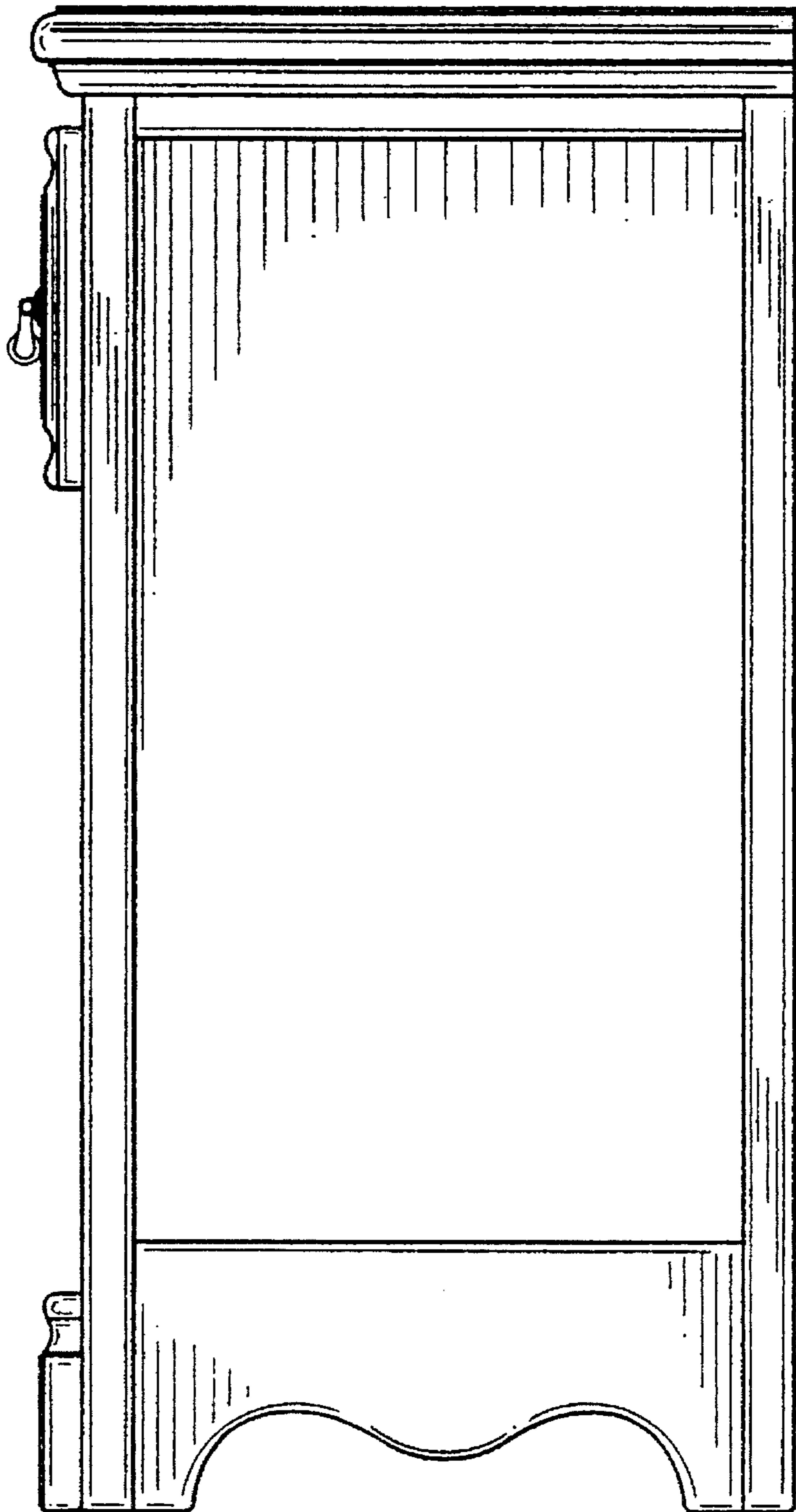

FIG-5

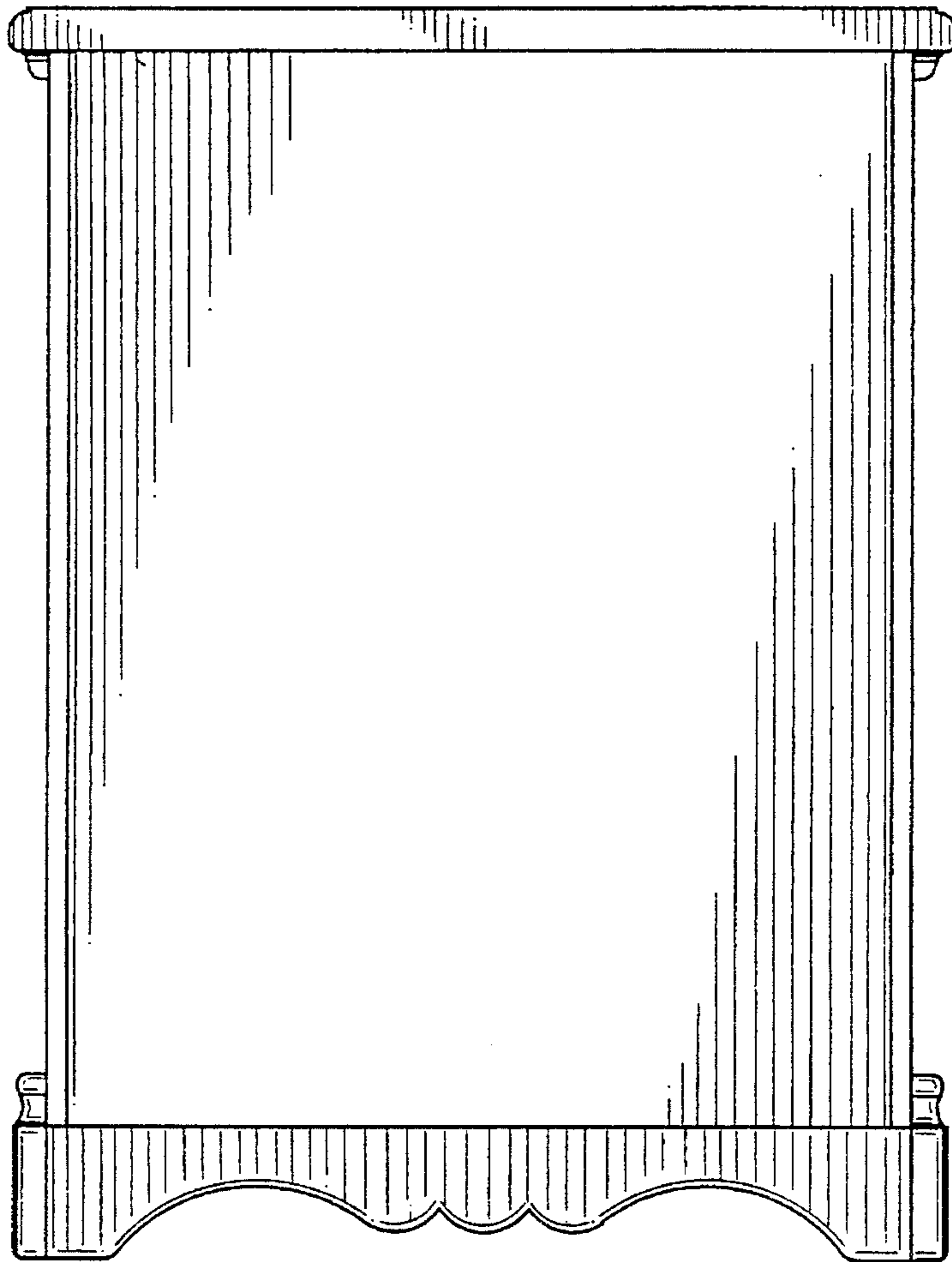

FIG-6

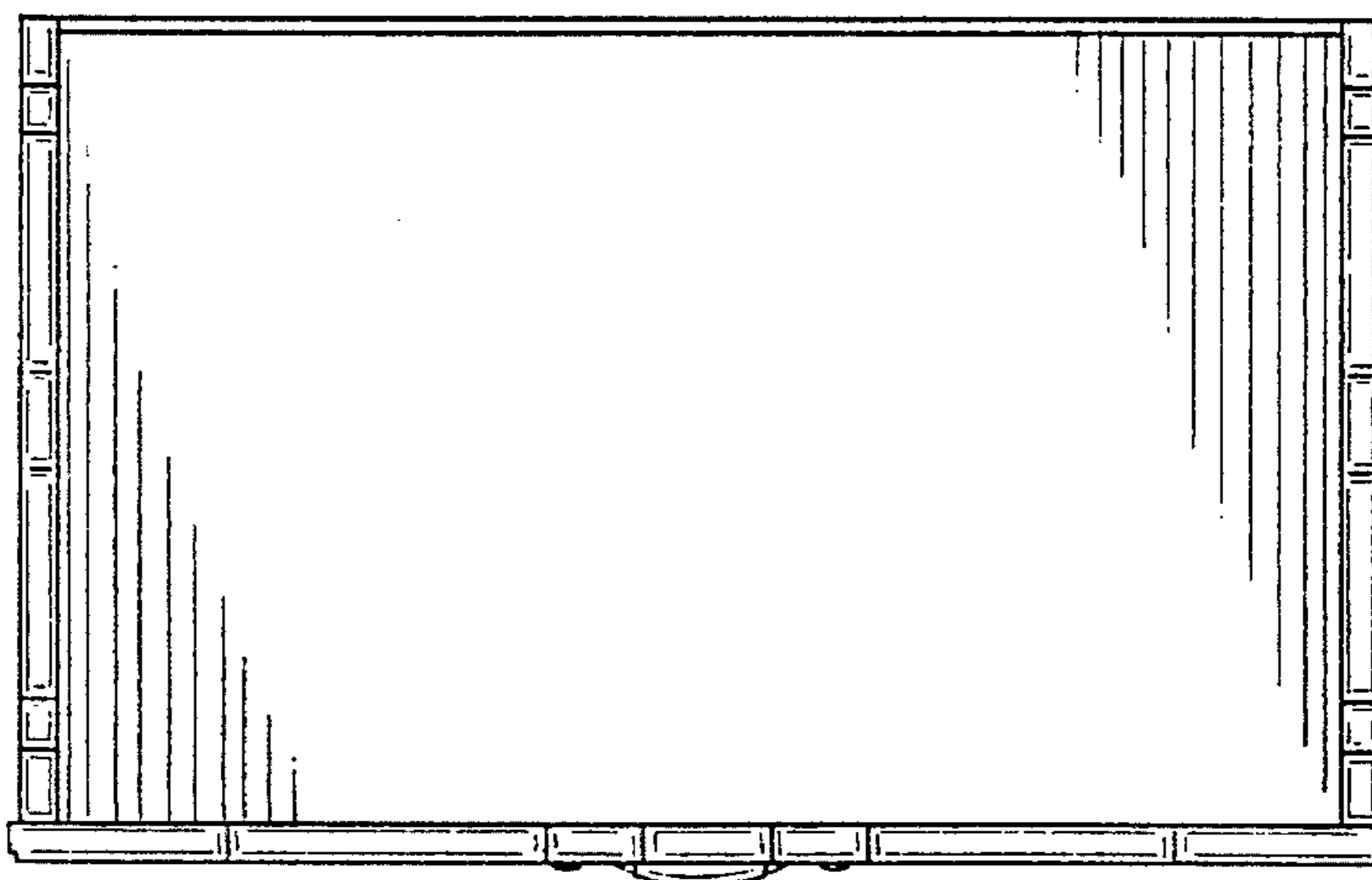

FIG-7

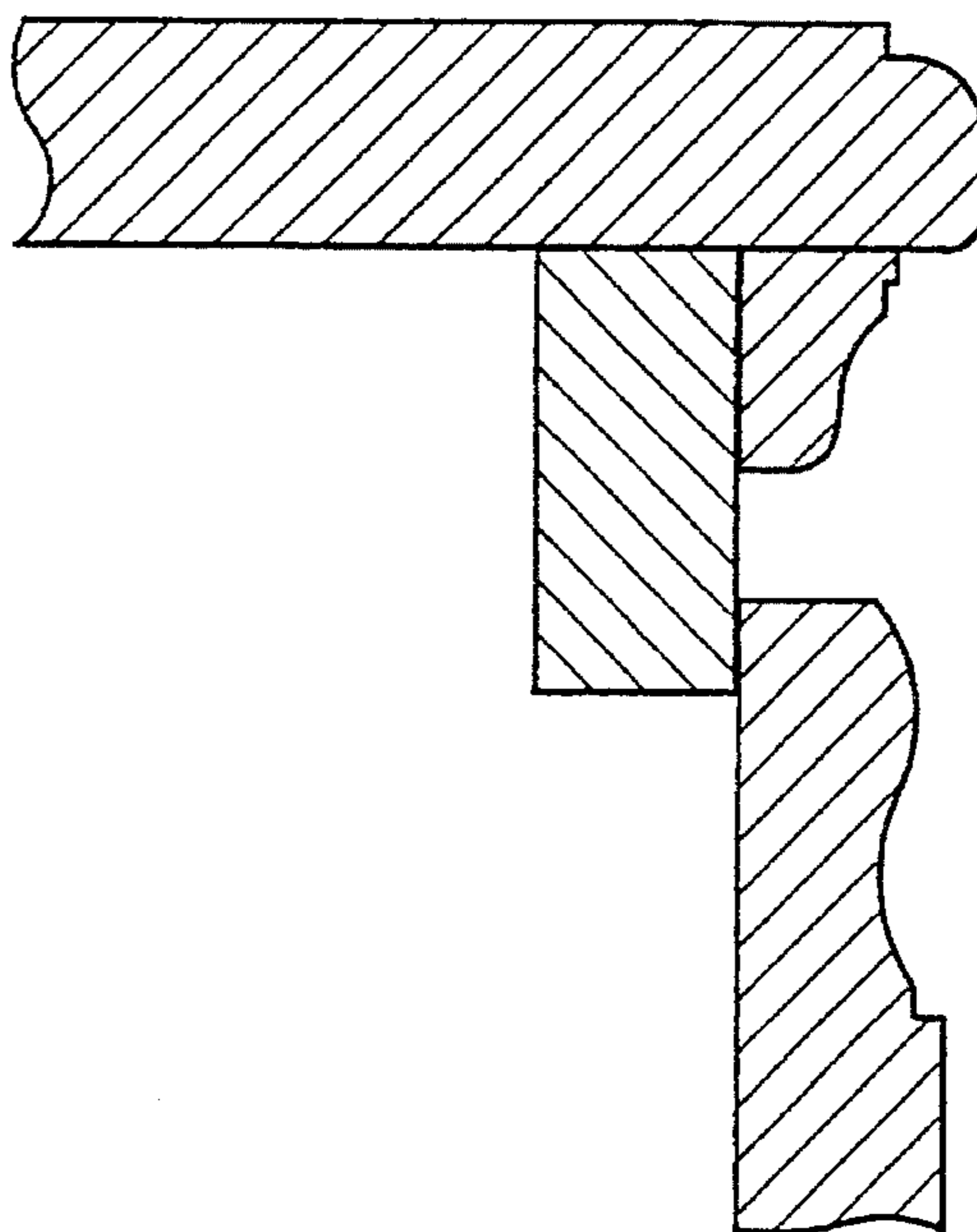

FIG-8

