



US00D368373S

# United States Patent [19]

Shimatsu et al.

[11] Patent Number: **Des. 368,373**

[45] Date of Patent: **\*\*Apr. 2, 1996**

[54] **COMBINED ELECTRIC TOOTHBRUSH AND CHARGING BASE THEREFOR**

[75] Inventors: **Scott T. Shimatsu**, Alhambra; **Cleve A. Graham**, Simi Valley; **Spencer L. Mackay**, Agoura Hills; **Stanfield K. Young**, Cypress, all of Calif.

[73] Assignee: **Bausch & Lomb Incorporated**, Rochester, N.Y.

[\*\*] Term: **14 Years**

[21] Appl. No.: **29,537**

[22] Filed: **Oct. 7, 1994**

[52] U.S. Cl. .... **D4/101**

[58] **Field of Search** ..... D4/101, 104-113, D4/121, 116, 121, 134, 136, 138, 199; D13/107-108; 15/22.1, 22.2, 23-25, 28-29, 105, 159.1, 160, 167.1, 167.2, 186-188; 601/141-142

[56] **References Cited**

**U.S. PATENT DOCUMENTS**

D. 210,349	3/1968	Boldt	.....	D4/101
D. 303,876	10/1989	Clemens et al.	.....	D4/101
D. 318,918	8/1991	Hartwein	.....	D24/111
D. 328,816	8/1992	Cook et al.	.....	D3/39
D. 341,943	12/1993	Si-Hoe	.....	D4/108
D. 342,718	12/1993	Mackay	.....	D13/108
3,489,936	1/1970	Boyles	.....	310/47
3,577,579	5/1971	Duve et al.	.....	15/22
3,954,407	5/1976	Andary et al.	.....	21/83
4,156,620	5/1979	Clemens	.....	134/6
4,274,173	6/1981	Cohen	.....	15/28
4,827,550	5/1989	Graham et al.	.....	15/22
4,845,795	7/1989	Crawford et al.	.....	15/22
4,974,278	12/1990	Hommann	.....	15/22
5,028,413	7/1991	Bianchi et al.	.....	424/52

5,033,617	7/1991	Hartwein et al.	.....	206/362.1
5,054,149	10/1991	Si-Hoe et al.	.....	15/28
5,077,855	1/1992	Ambasz	.....	15/22.1
5,142,723	9/1992	Lustig et al.	.....	15/22.1
5,283,921	2/1994	Ng	.....	15/22.1
5,309,591	5/1994	Hagele et al.	.....	15/22.1

*Primary Examiner*—A. Hugo Word  
*Assistant Examiner*—Lavone D. Tabor  
*Attorney, Agent, or Firm*—Katherine H. McGuire

[57] **CLAIM**

The ornamental design for a combined electric toothbrush and charging base therefor, as shown and described.

**DESCRIPTION**

FIG. 1 is a front elevational view of the electric toothbrush portion of our new design, shown separately for clarity of illustration only;

FIG. 2 is a side elevational view thereof, the opposite side, with the exception of the marking on the first round button shown on the triangular protrusion on the handle, being a mirror image;

FIG. 3 is a rear, elevational view thereof;

FIG. 4 is a top plan view thereof;

FIG. 5 is a bottom plan view thereof;

FIG. 6 is a perspective view of the combined electric toothbrush and charging base embodying our new design;

FIG. 7 is a top plan view of the charging base portion, shown separately for clarity of illustration only;

FIG. 8 is a bottom plan view of FIG. 7;

FIG. 9 is a front elevational view of FIG. 7;

FIG. 10 is a rear elevational view of FIG. 7;

FIG. 11 is an elevational view thereof as seen rotated clockwise 45° from the position of FIG. 10;

FIG. 12 is an elevational view thereof as seen rotated 45° counter-clockwise from the position of FIG. 10; and,

FIG. 13 is a perspective view of FIG. 7.

**1 Claim, 5 Drawing Sheets**

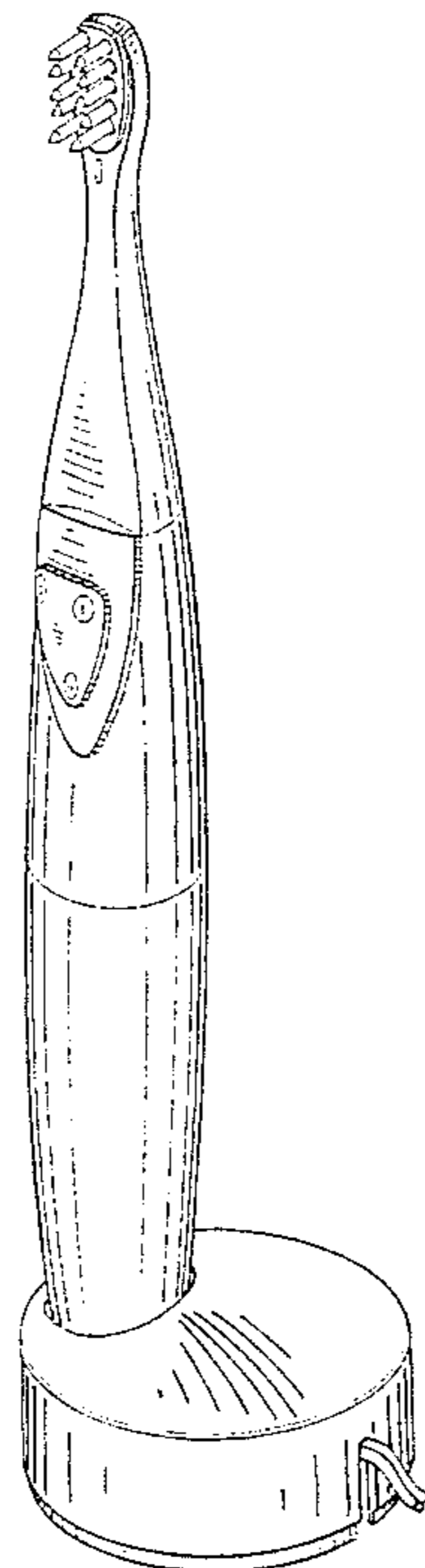

FIG. 1

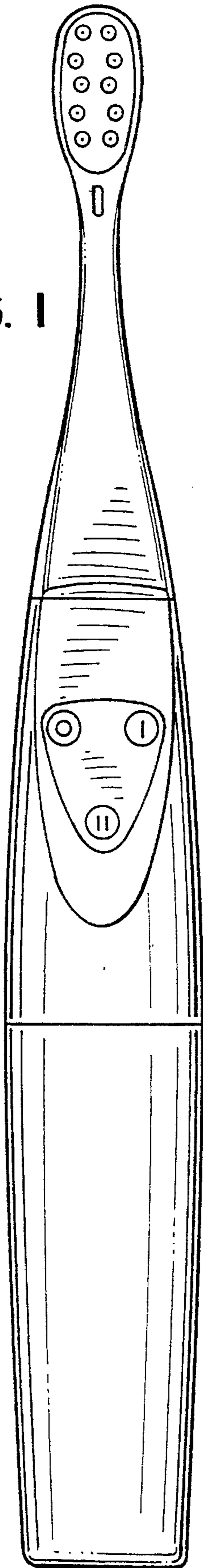
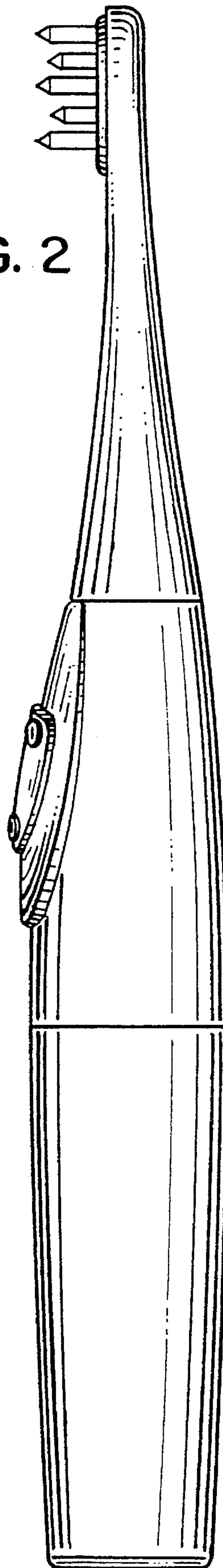

FIG. 2



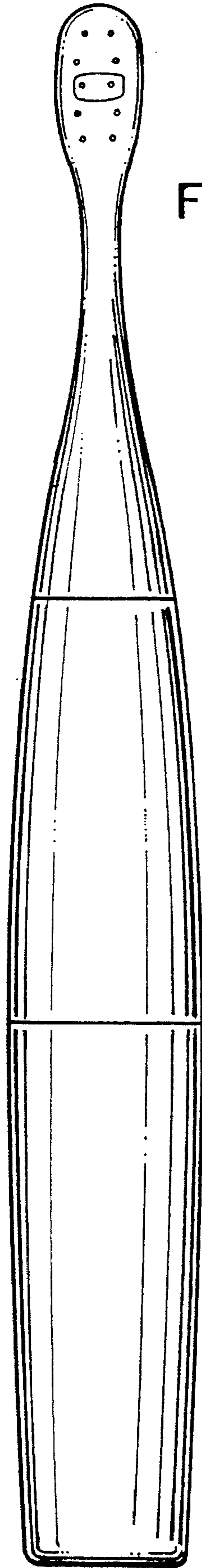

FIG. 3

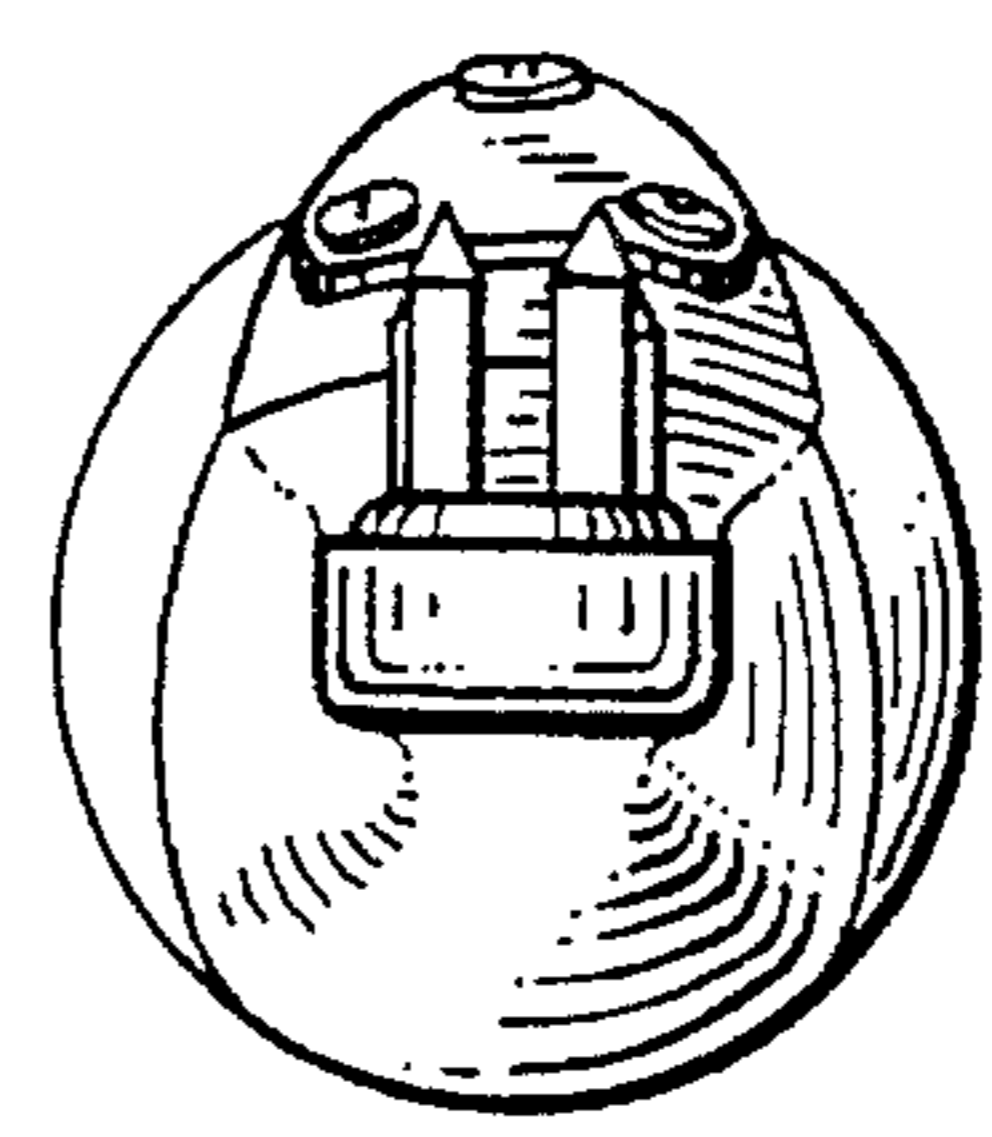

FIG 4

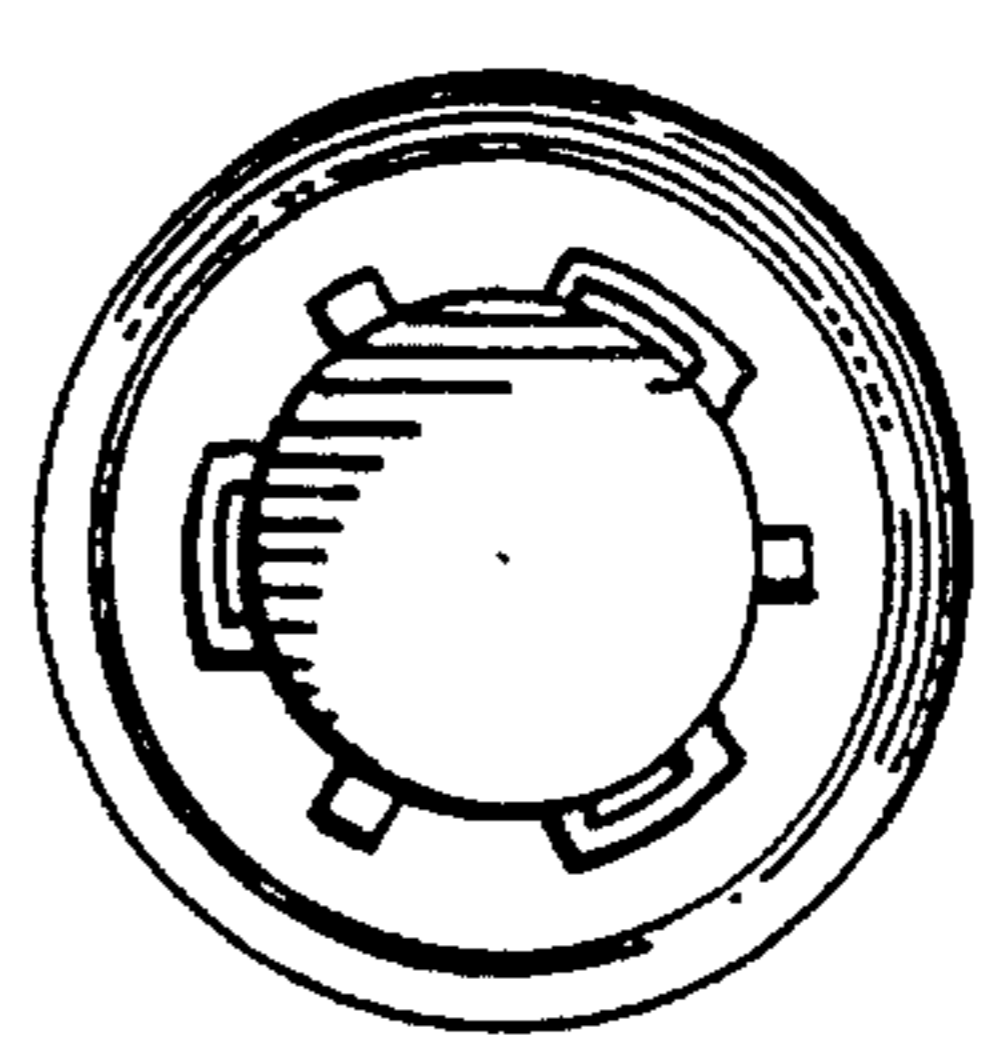

FIG. 5

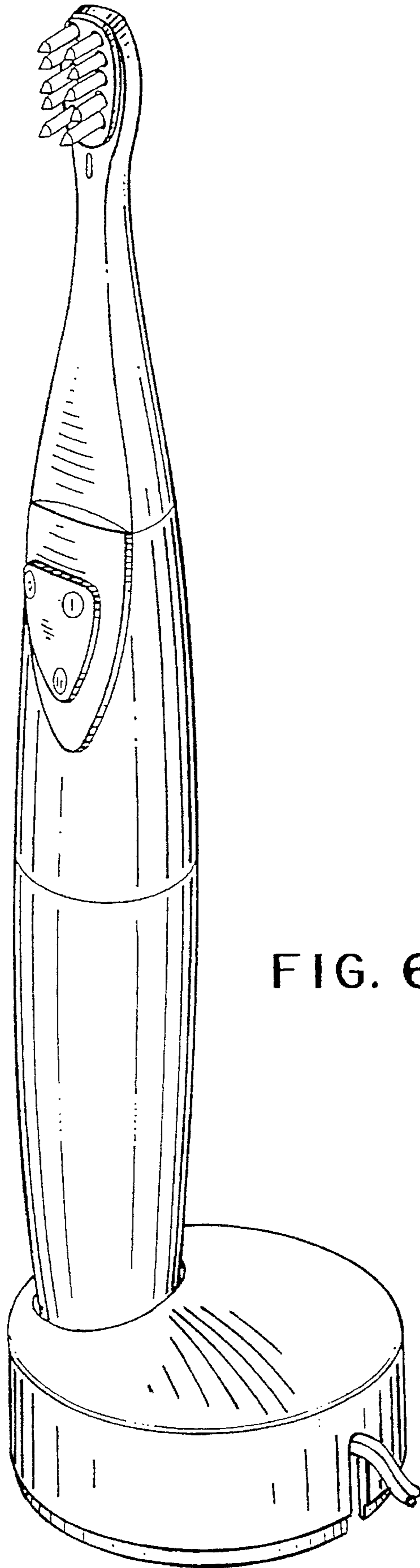

FIG. 6

FIG. 7

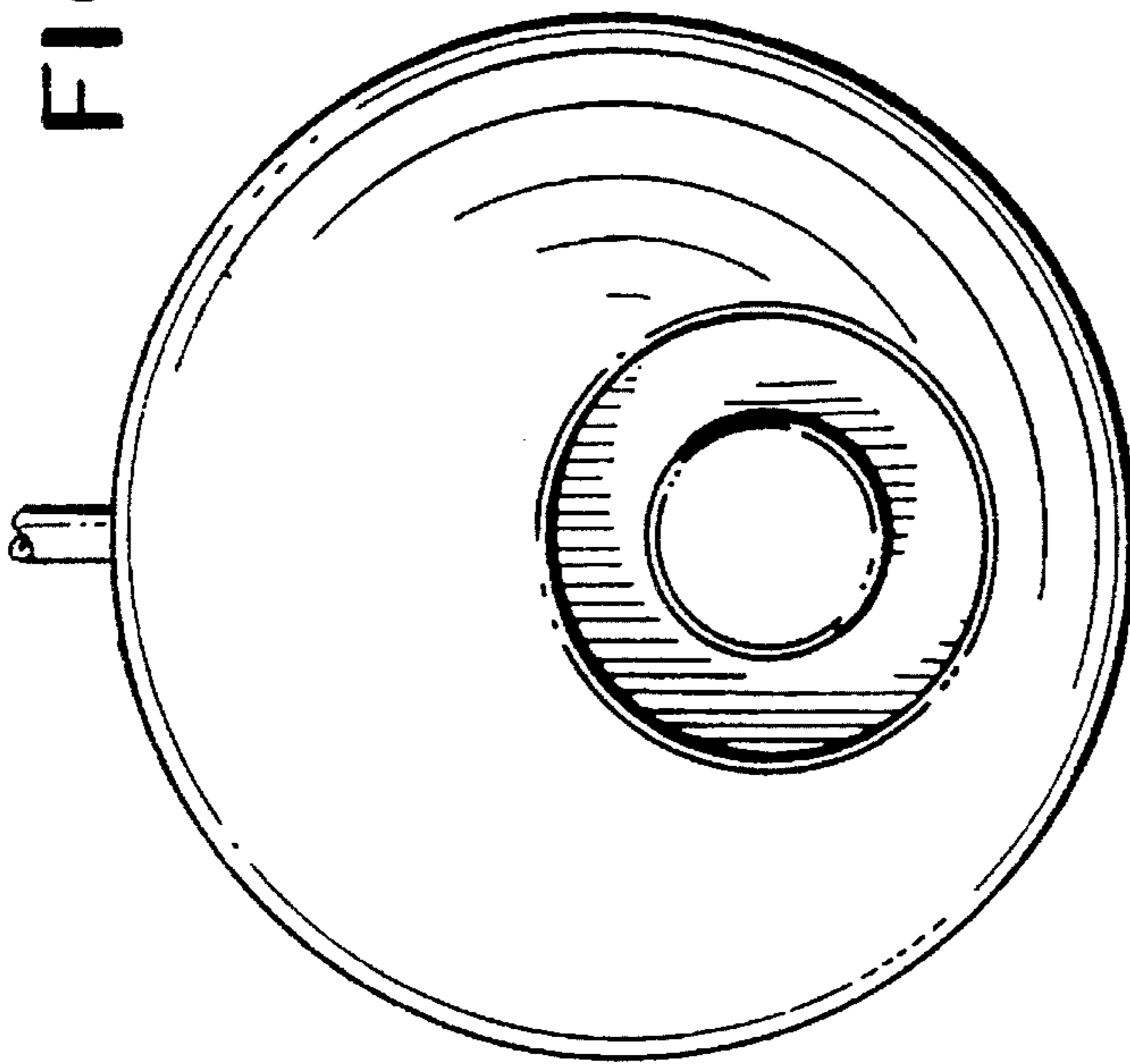

FIG. 8

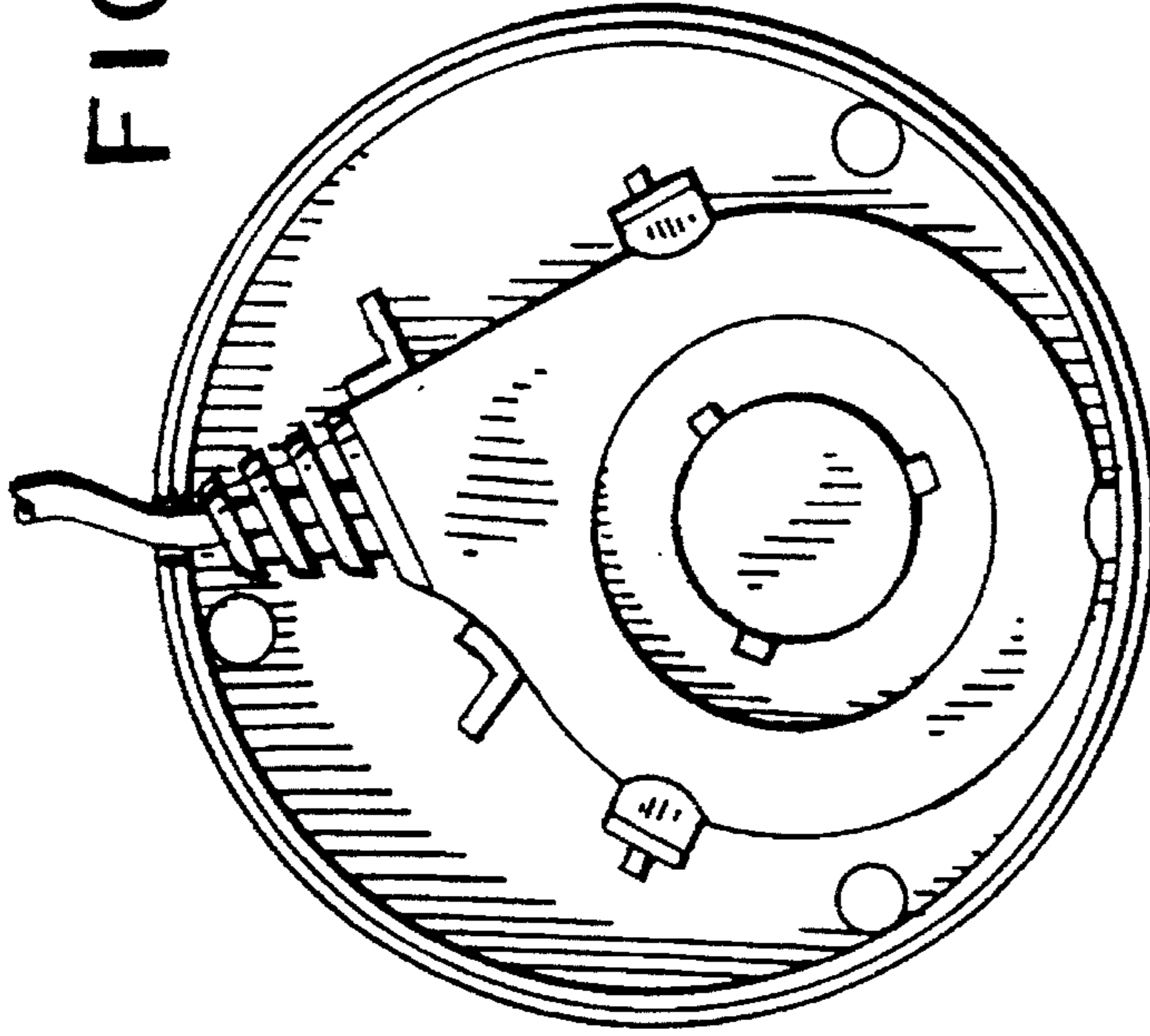

FIG. 9

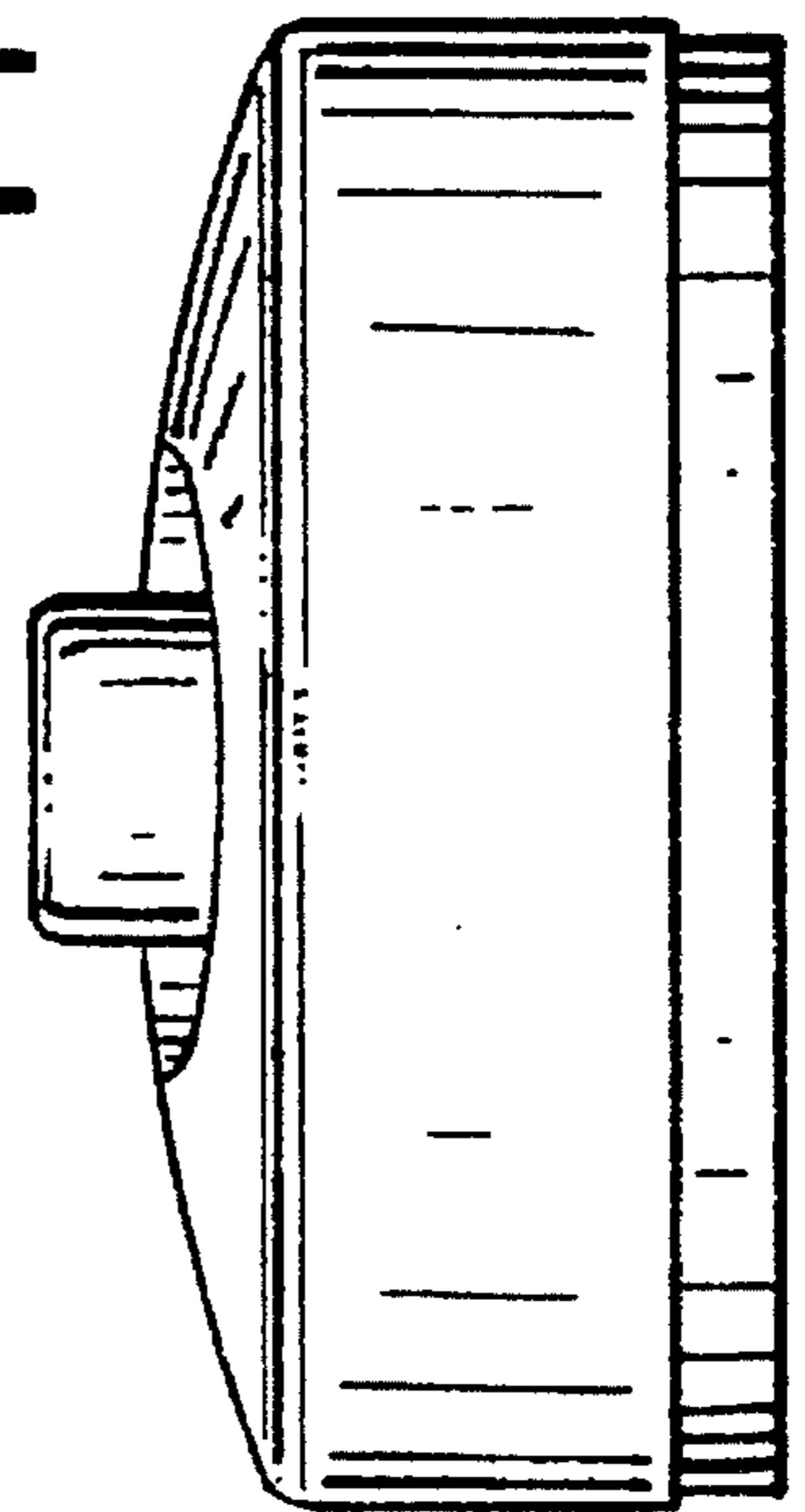
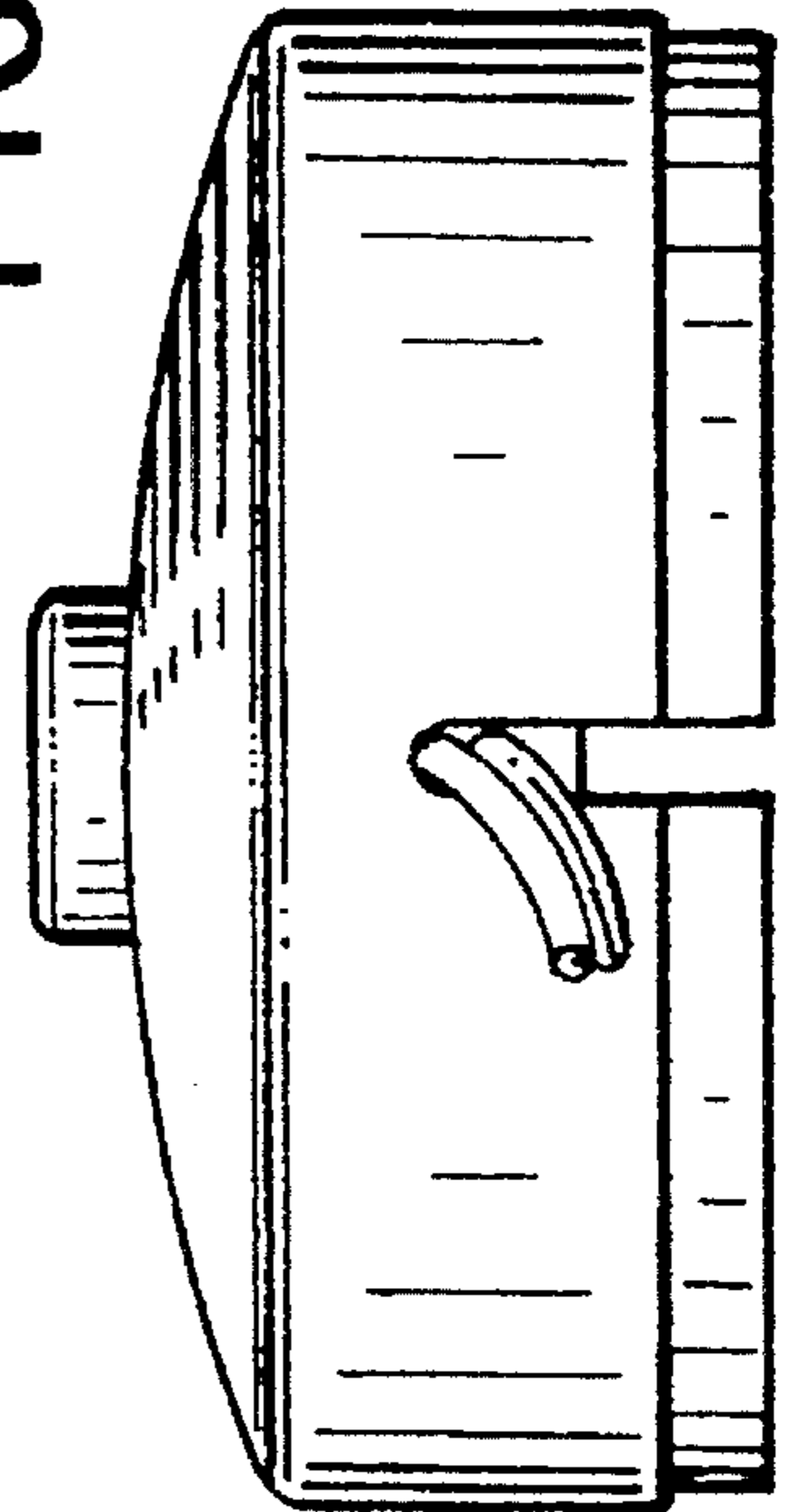

FIG. 10



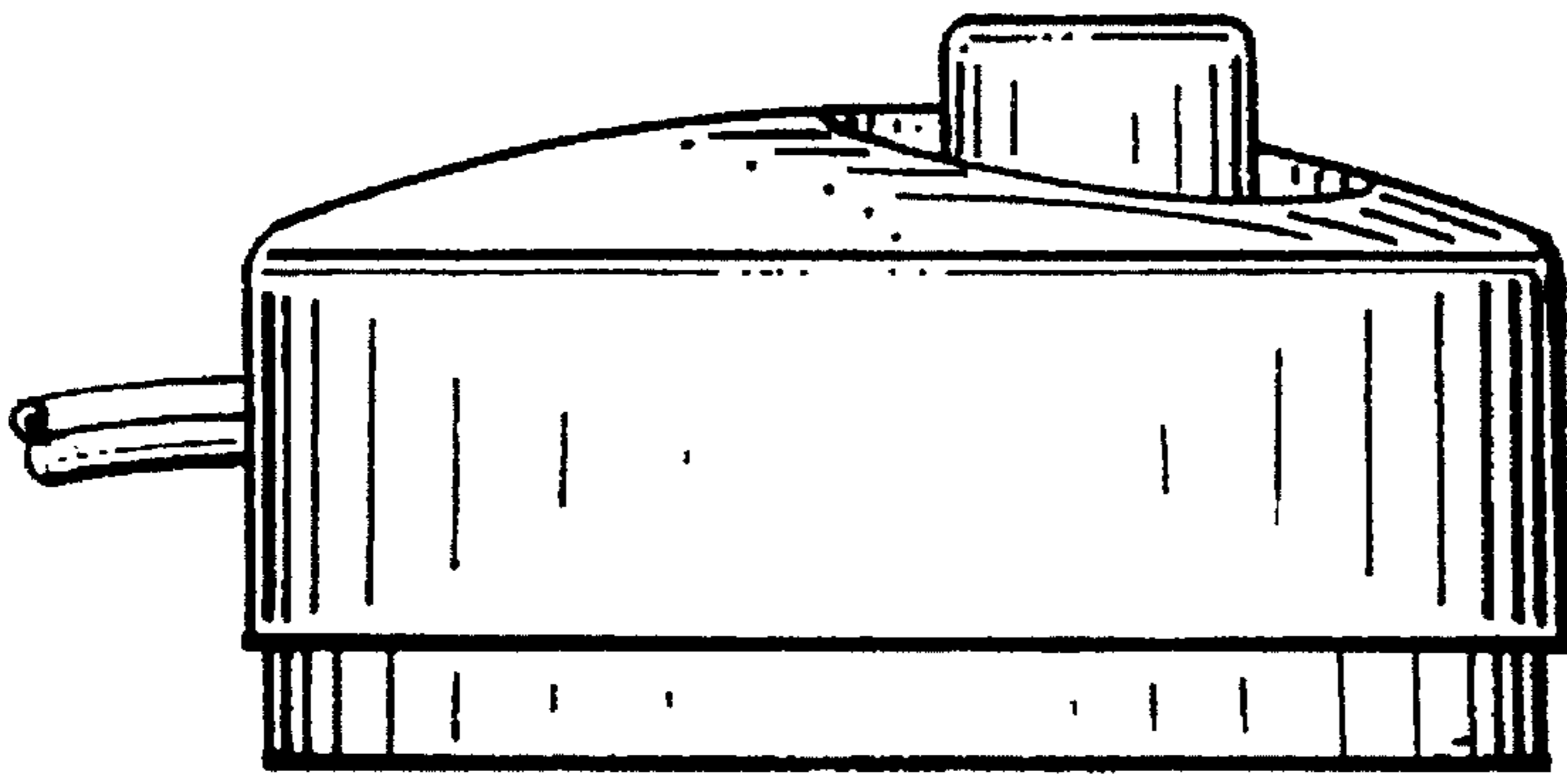

FIG. 11

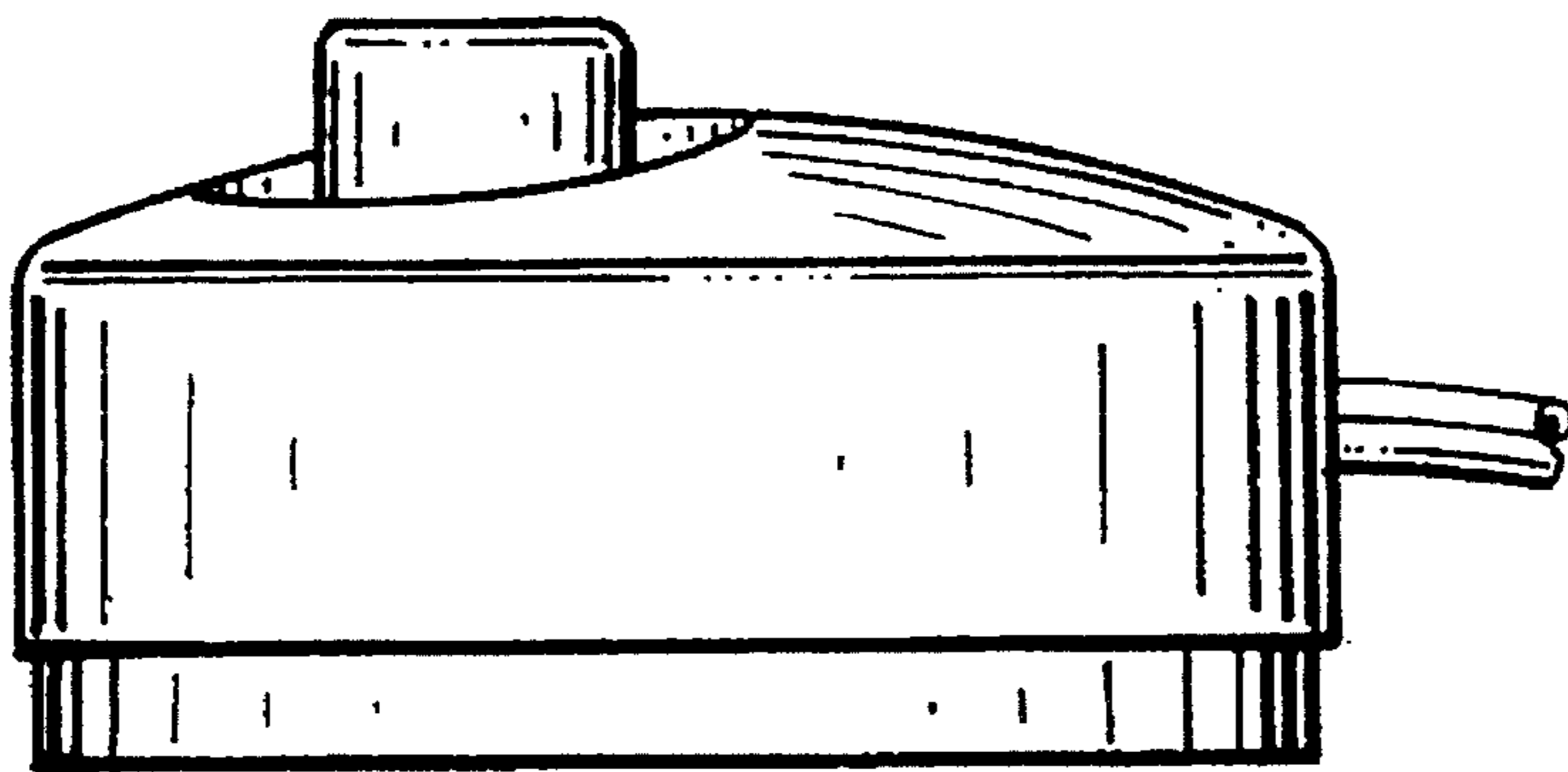

FIG. 12

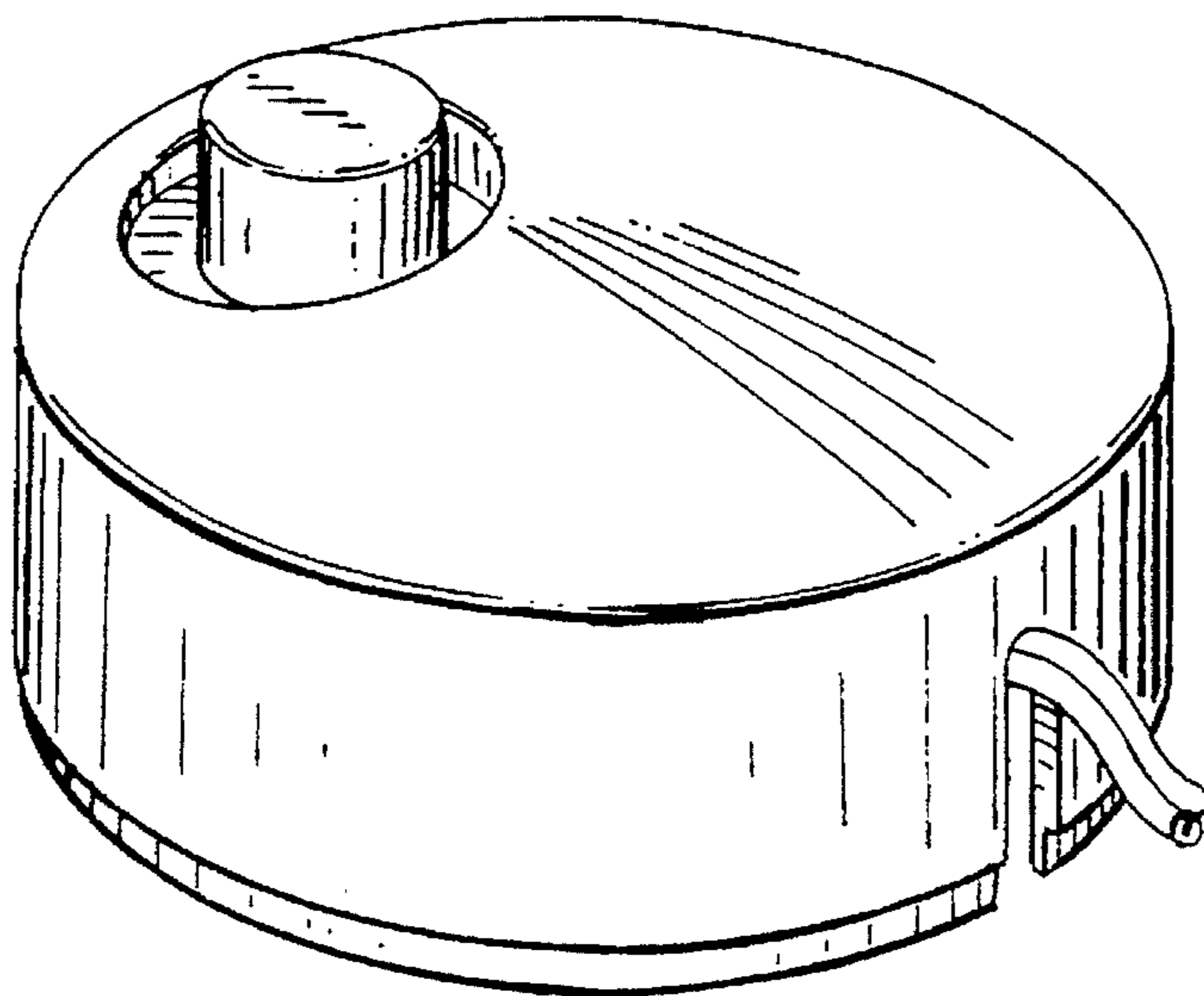

FIG. 13