



US00D368347S

# United States Patent [19] Kruger

[11] Patent Number: **Des. 368,347**

[45] Date of Patent: **\*\*Mar. 26, 1996**

[54] PAIL

[75] Inventor: **Cory J. Kruger**, Gardner, Mass.

[73] Assignee: **Sterilite Corporation**, Townsend, Mass.

[\*\*] Term: **14 Years**

[21] Appl. No.: **26,289**

[22] Filed: **Jun. 30, 1994**

[52] U.S. Cl. .... **D32/53**

[58] Field of Search ..... D32/53, 53.1,  
D32/54, 37; D22/136; 15/262, 264, 257.05,  
257.06; 220/694, 695, 696, 773, 774

### [56] References Cited

#### U.S. PATENT DOCUMENTS

D. 200,265	2/1965	Smith et al. ....	D32/53
D. 204,507	4/1966	Davis .....	D32/53
D. 280,038	8/1985	Anderson .....	D32/53
D. 353,241	12/1994	Breen .....	D32/53
2,051,940	8/1936	Chichester-Miles .....	D32/53
3,419,196	12/1968	Moore .....	220/773

#### OTHER PUBLICATIONS

Frem #906; 6 qt. bucket w/molded handle.  
Frem #914; 14 qt. bucket w/molded handle.  
Curver #2860 & #2855; bucket w/molded handle.

Curver #4214; Picnic cooler w/molded handle.  
Reisenthel Programm München; bucket w/molded handles.  
Input Reisenthel perguzzini; bucket w/molded handle.  
Buchsteiner; 6.1 Young Generation carry basket.  
Buchsteiner; 3.2 Klassische Stapelartikel; 10 liter bucket.  
Buchsteiner; 3.2 Klassische Stapelartikel; 5 liter bucket.

*Primary Examiner*—A. Hugo Word  
*Assistant Examiner*—Robin V. Taylor  
*Attorney, Agent, or Firm*—Donald Brown

### [57] CLAIM

The ornamental design for a pail, as shown and described.

### DESCRIPTION

FIG. 1 is a perspective view of the pail of this invention;  
FIG. 2 is a top plan view of the invention;  
FIG. 3 is a side elevation view of the invention, both side  
being identical;  
FIG. 4 is a front end view of the invention looking from the  
right of FIG. 2;  
FIG. 5 is a back end view of the invention looking from the  
left of FIG. 2; and,  
FIG. 6 is a bottom view of the pail.

**1 Claim, 3 Drawing Sheets**

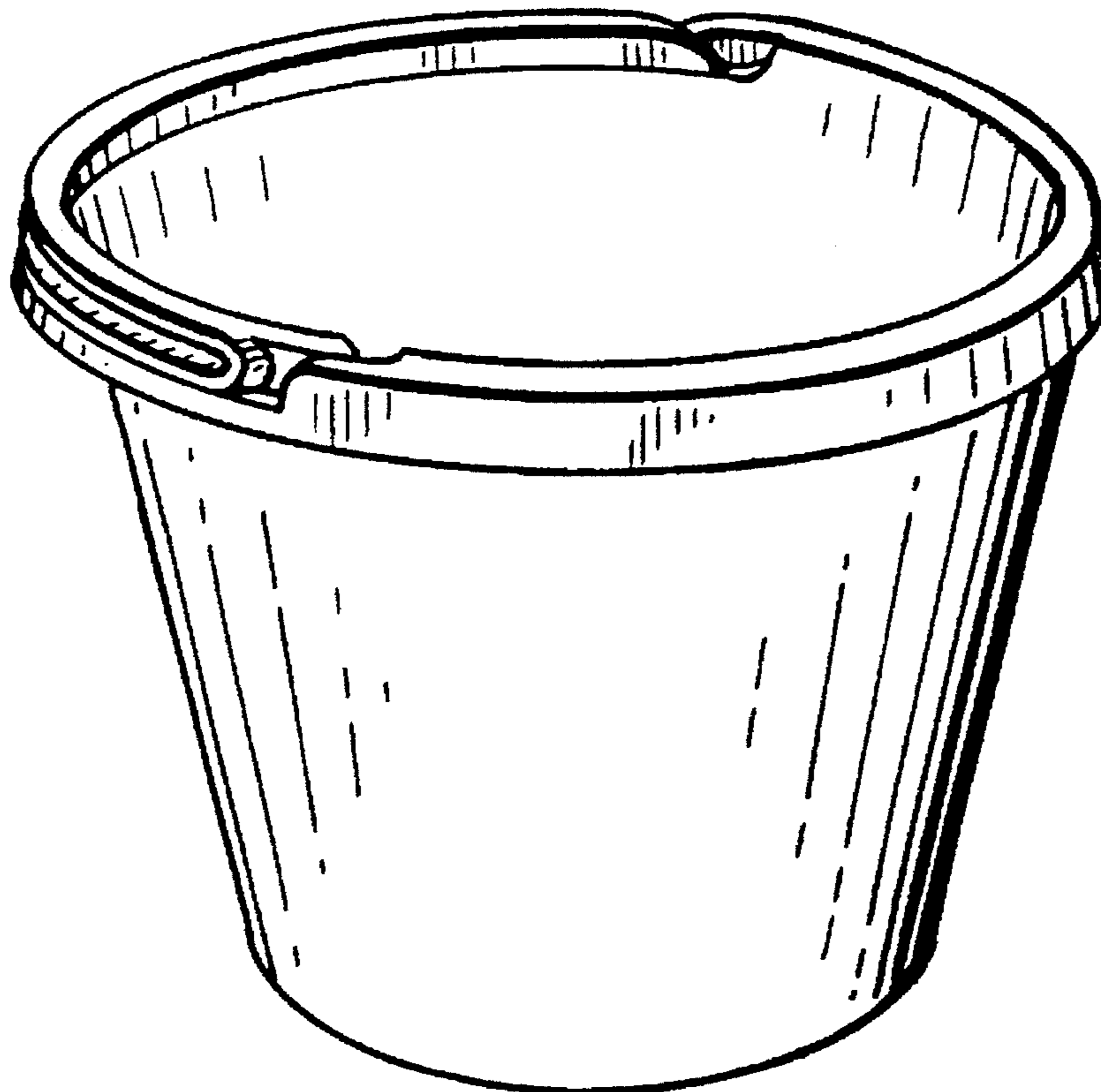

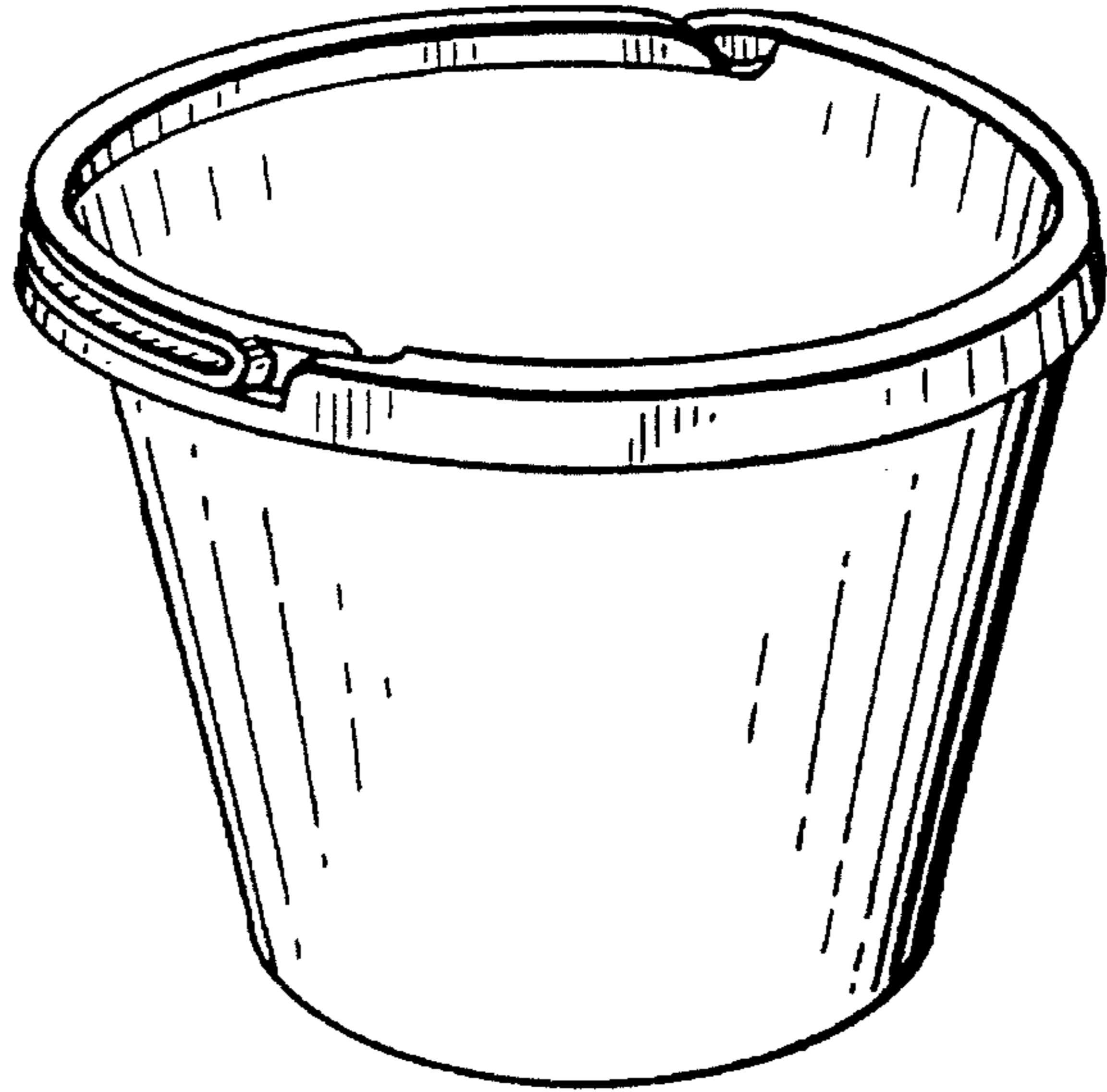

FIG. 1

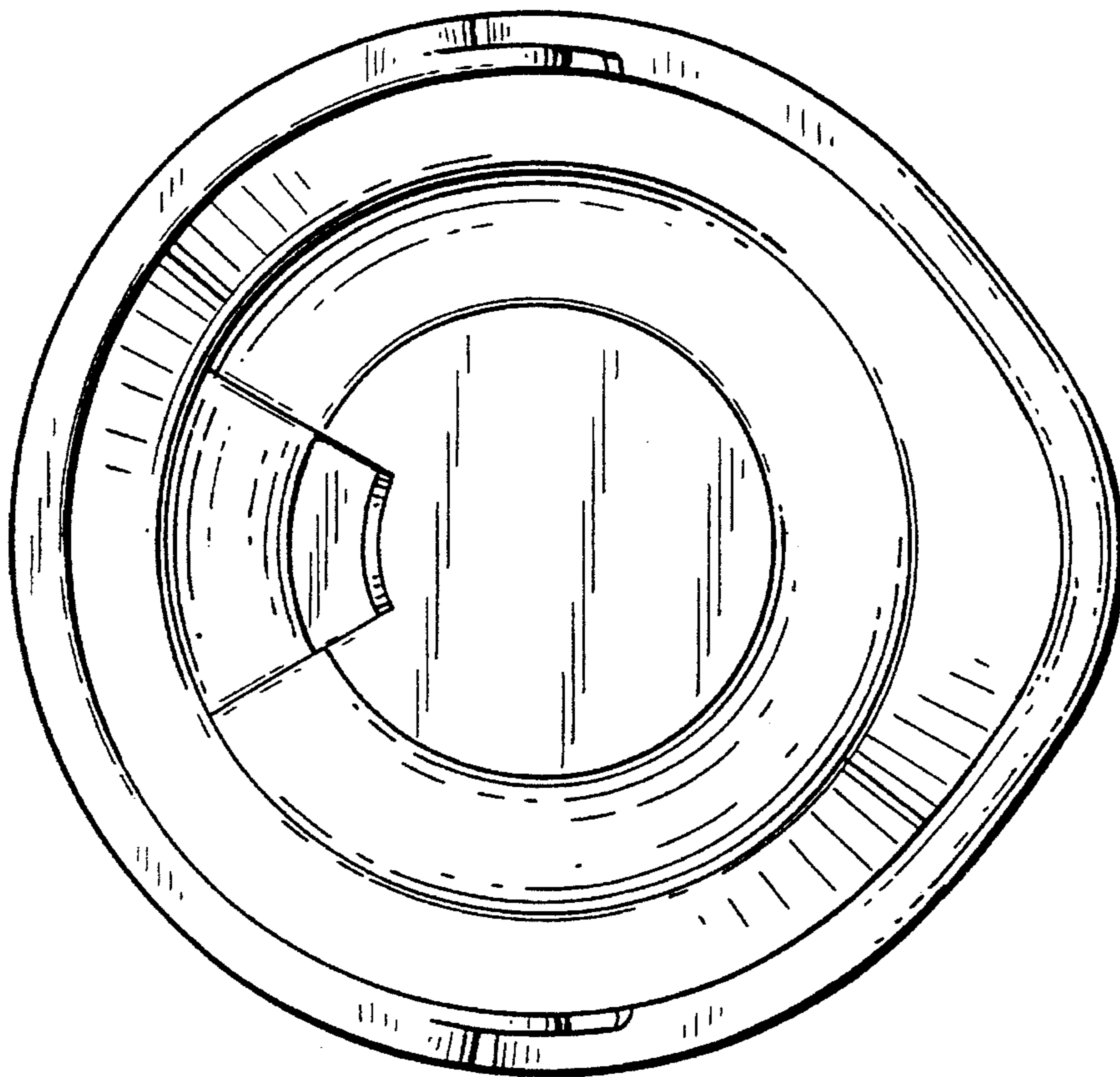

FIG. 2

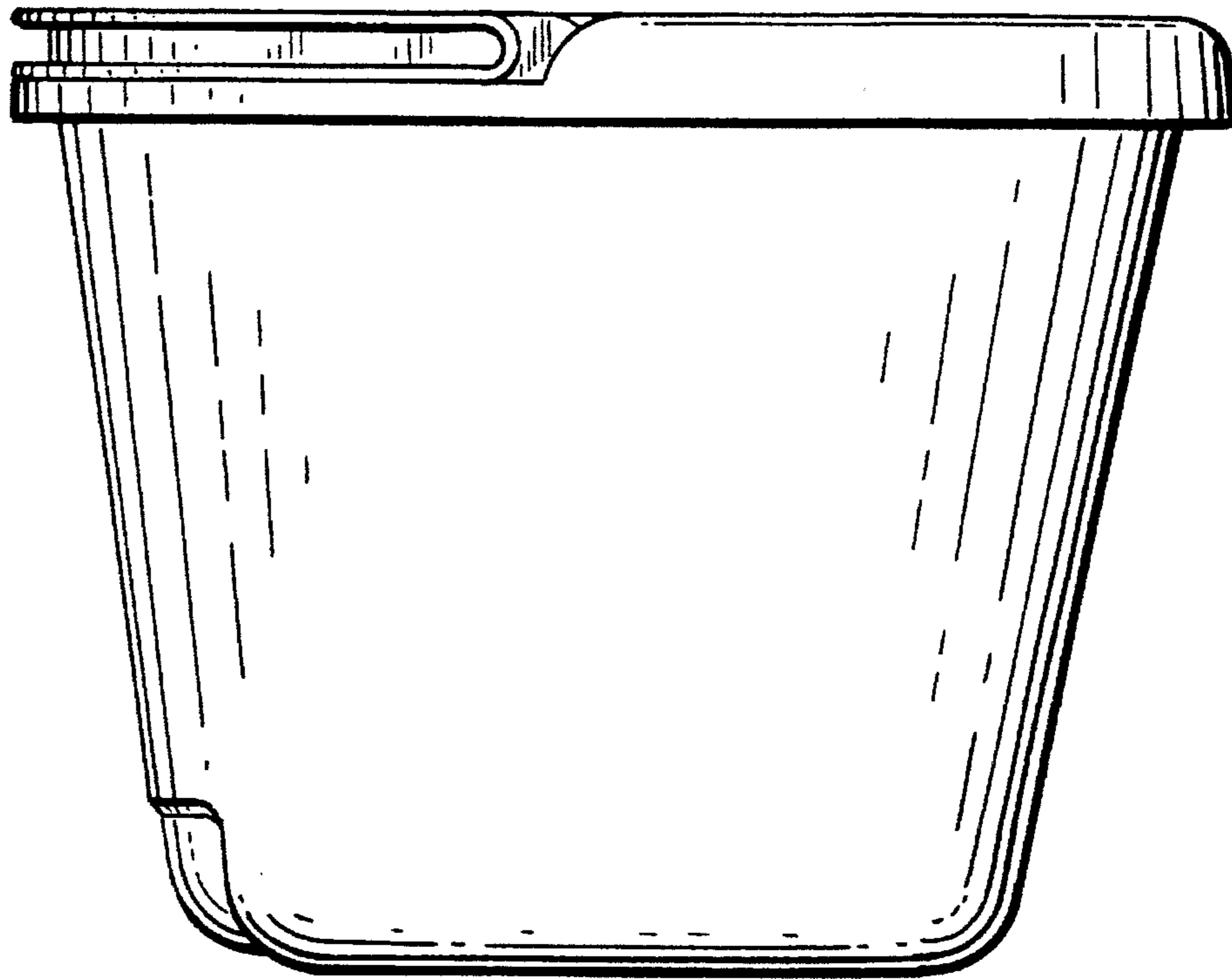

FIG. 3

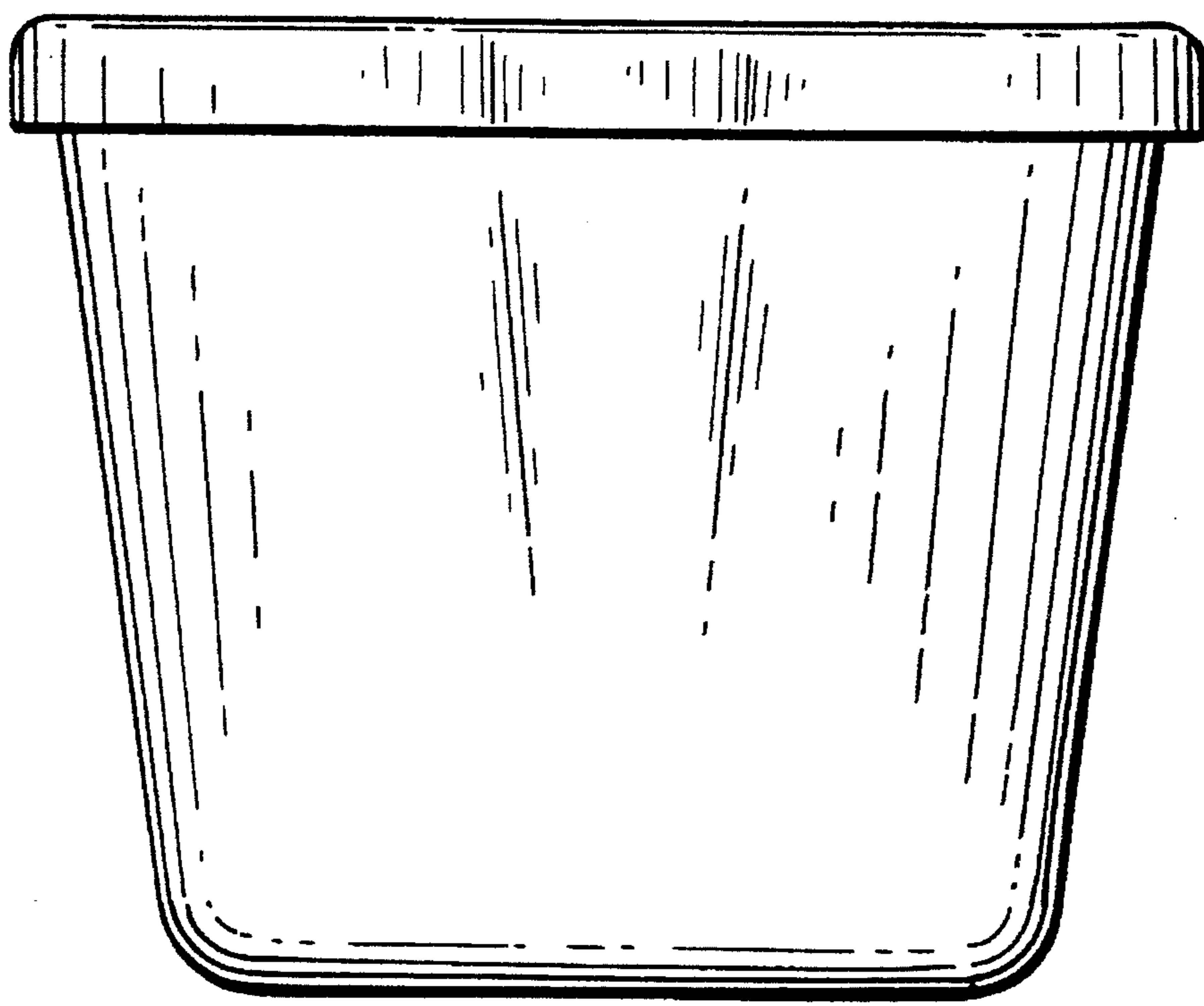

FIG. 4

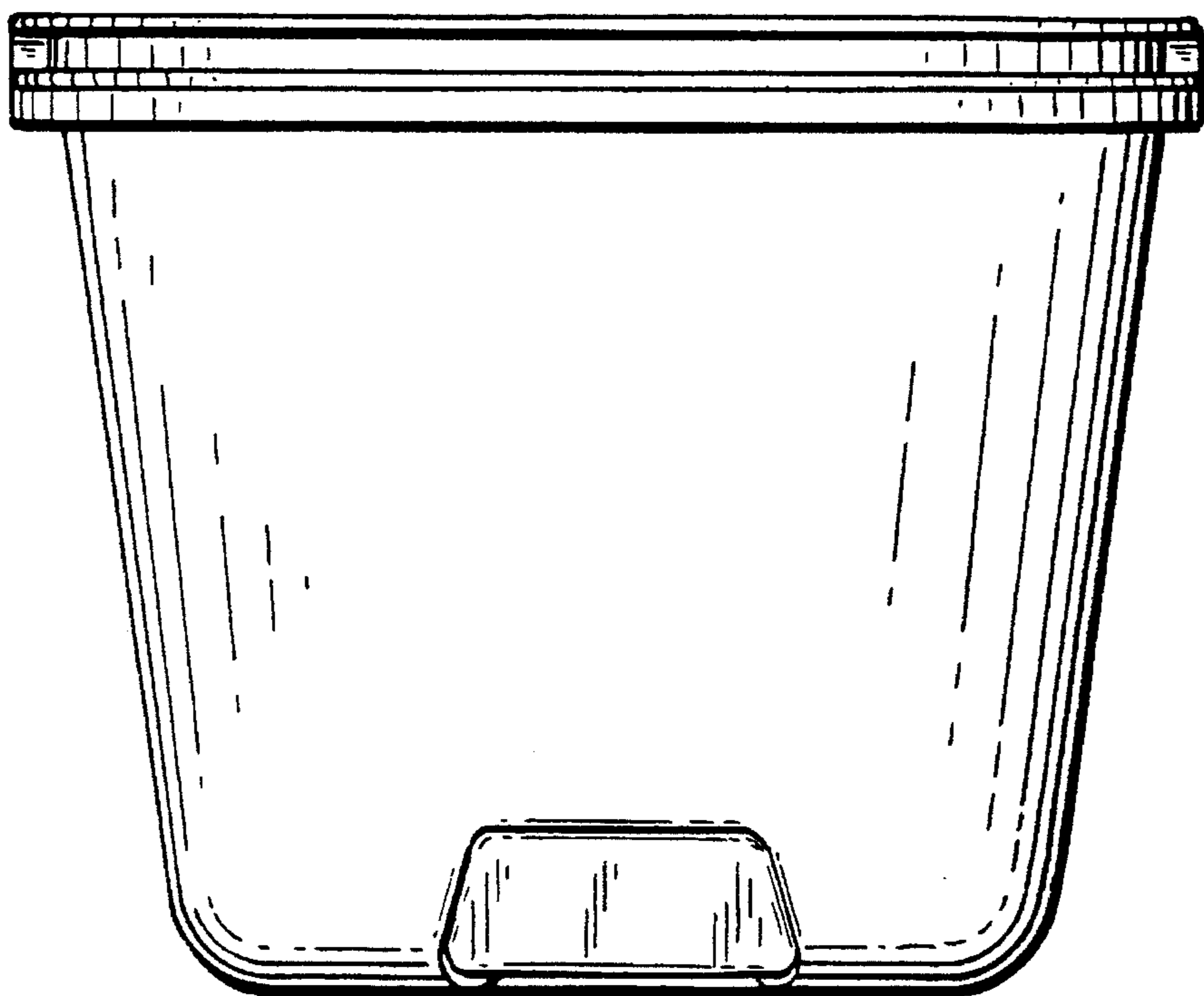

FIG. 5

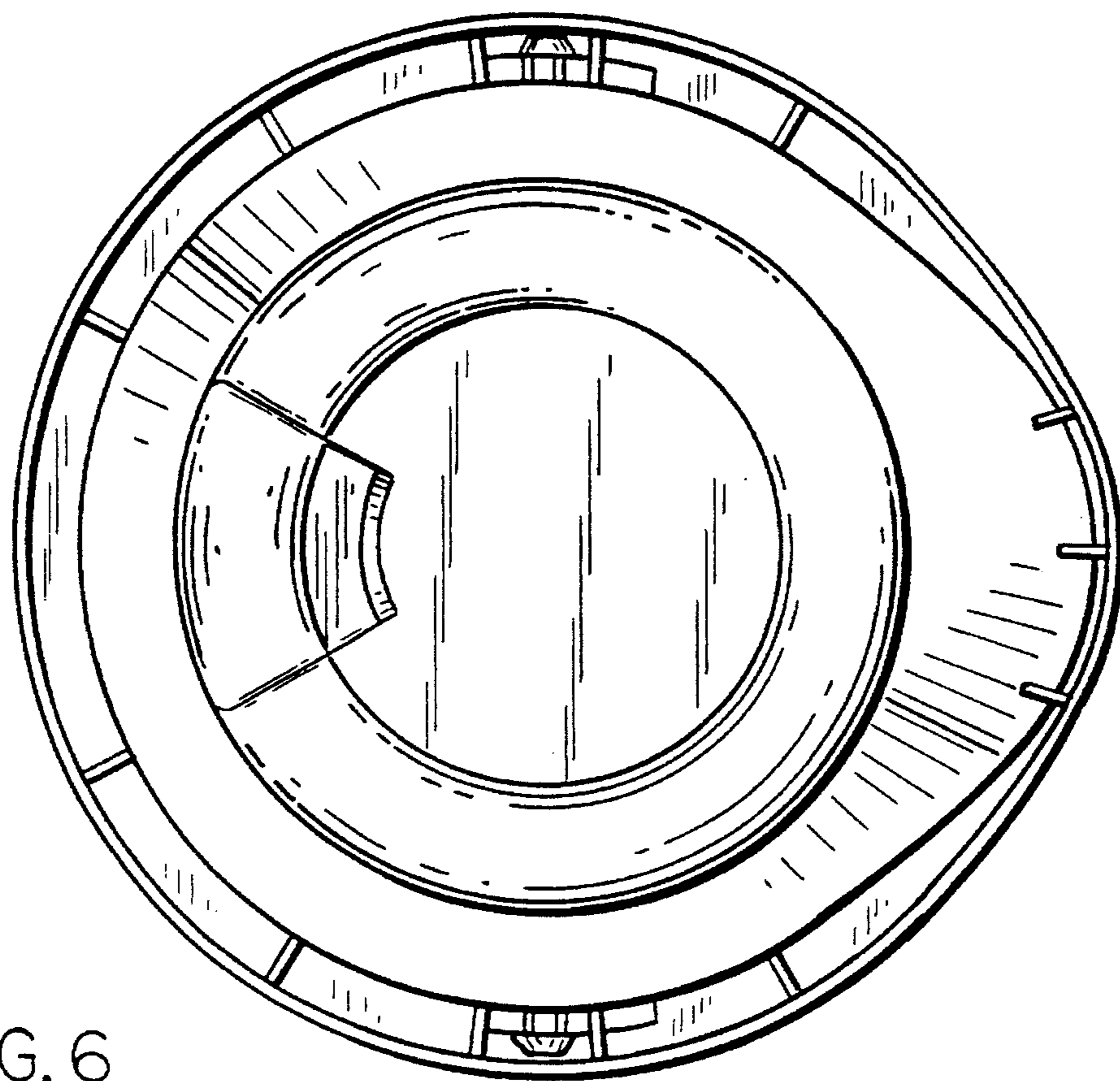

FIG. 6