



US00D368310S

# United States Patent [19] Ouellette

[11] Patent Number: **Des. 368,310**

[45] Date of Patent: **\*\*Mar. 26, 1996**

[54] **SKIN ANALYZER**

[75] Inventor: **Loren R. Ouellette**, Laguna Hills, Calif.

[73] Assignee: **Microline Technologies, Inc.**, Laguna Hills, Calif.

[\*\*] Term: **14 Years**

[21] Appl. No.: **28,002**

[22] Filed: **Sep. 1, 1994**

[52] U.S. Cl. .... **D24/186**

[58] Field of Search ..... D24/186, 168, D24/165, 167; 128/743, 734, 632

4,558,707	12/1985	Miyamae et al. ....	128/683
4,588,943	5/1986	Hirth .....	324/61
4,670,010	1/1987	Dragone .....	604/289
4,727,310	2/1988	Hashimoto et al. ....	324/157
4,860,753	8/1989	Amerena .....	128/632
4,864,226	9/1989	Tachimoto et al. ....	324/157
4,911,544	3/1990	Walsh .....	350/600
4,966,158	10/1990	Honma et al. ....	128/734
5,001,436	3/1991	Scot et al. ....	324/689
5,097,830	3/1992	Eikefjord et al. ....	128/419
5,413,113	5/1995	Milne .....	128/743

Primary Examiner—Stella Reid  
 Attorney, Agent, or Firm—Fulwider Patton Lee & Utecht

### [57] CLAIM

The ornamental design for a skin analyzer, as shown and described.

### DESCRIPTION

FIG. 1 is a front, top perspective view of the skin analyzer showing my new design;  
 FIG. 2 is a top, rear, left-side perspective view thereof;  
 FIG. 3 is a top plan view thereof;  
 FIG. 4 is a bottom plan view thereof;  
 FIG. 5 is a right side elevational view thereof, the left side elevational view being identical;  
 FIG. 6 is a front elevational view thereof; and,  
 FIG. 7 is a rear elevational view thereof.

1 Claim, 3 Drawing Sheets

### [56] References Cited

#### U.S. PATENT DOCUMENTS

D. 243,284	2/1977	Myers .....	D24/186 X
D. 243,475	2/1977	Frazier .....	D24/186
D. 277,133	1/1985	Houlihan .....	D24/165
D. 285,965	9/1986	Nishibori et al. ....	D24/165
D. 286,676	11/1986	McJunkin .....	D24/17
D. 286,921	11/1986	Takigawa .....	D28/19
D. 297,051	8/1988	Kawamura .....	D24/165
D. 351,560	10/1994	Schneider .....	D10/56
3,761,810	9/1973	Fathauer .....	324/61 R
4,088,125	5/1978	Forgoine et al. ....	128/2.1 Z
4,096,852	6/1978	Adams .....	128/2 H
4,494,869	1/1985	Neumann .....	356/36

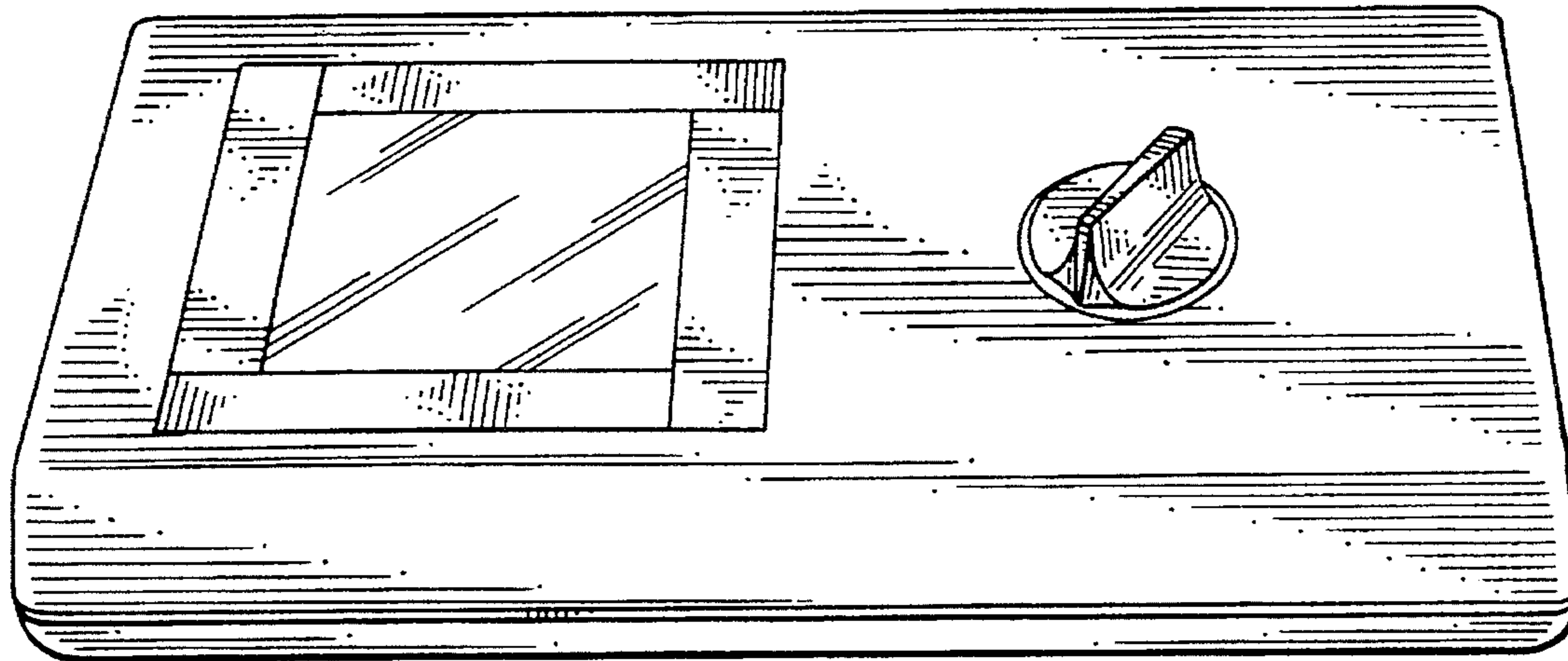

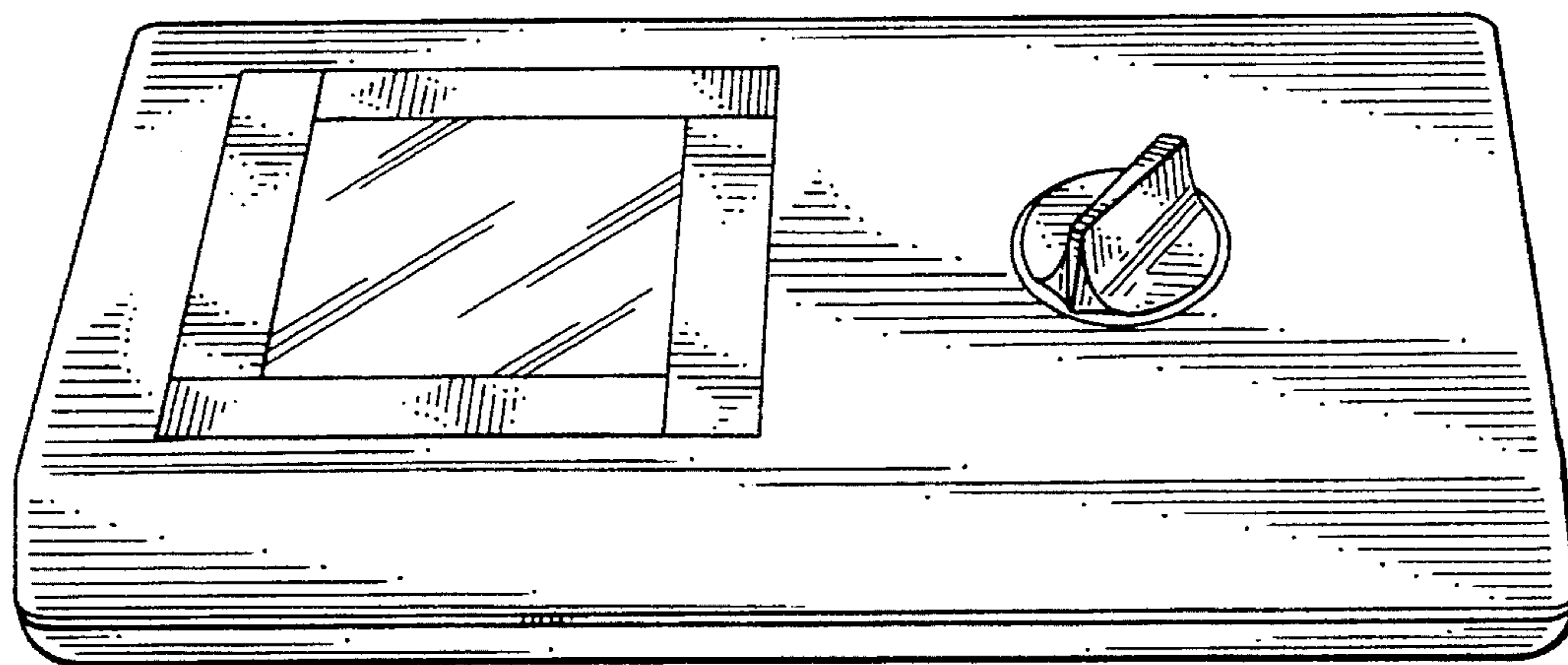

FIG. 1

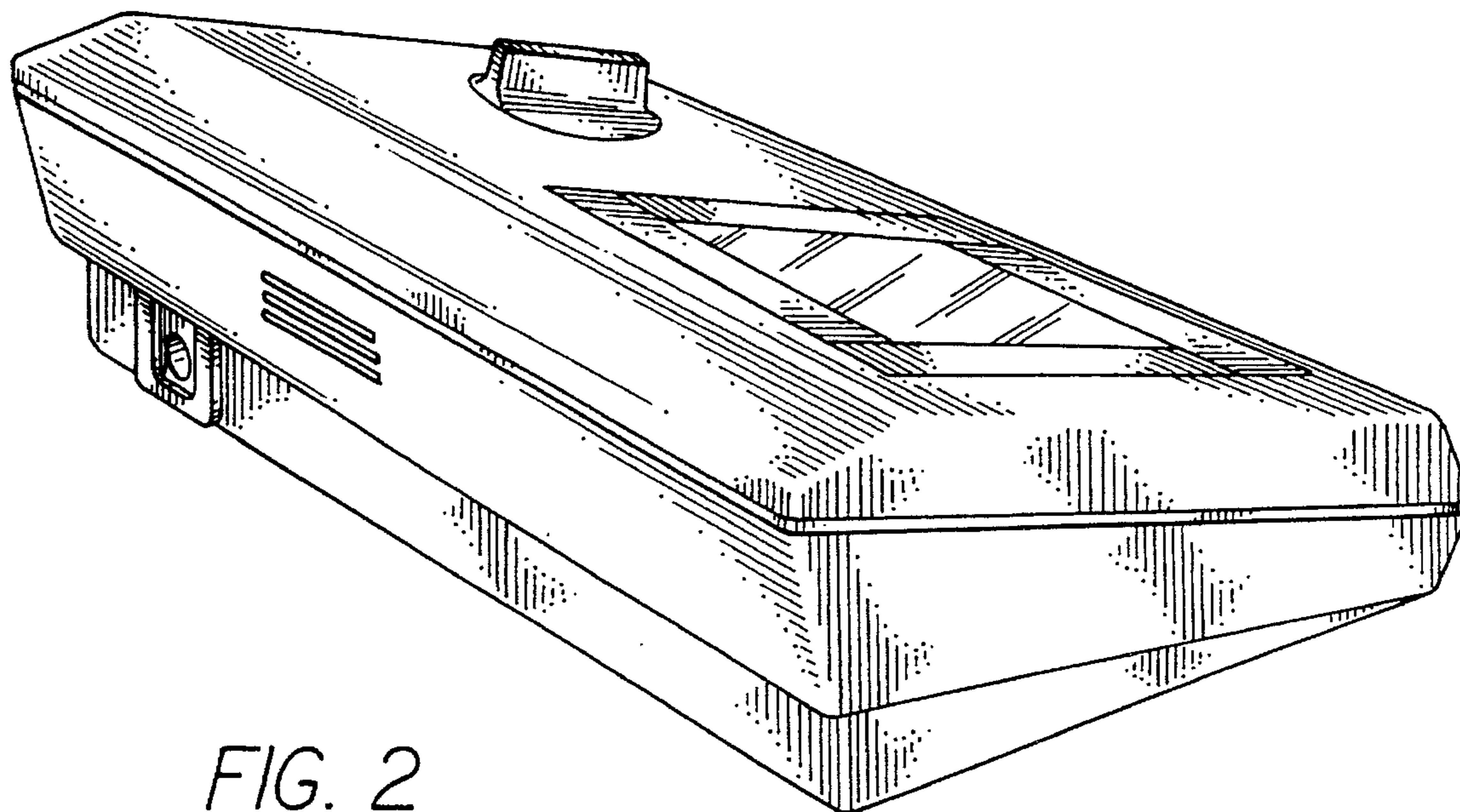

FIG. 2

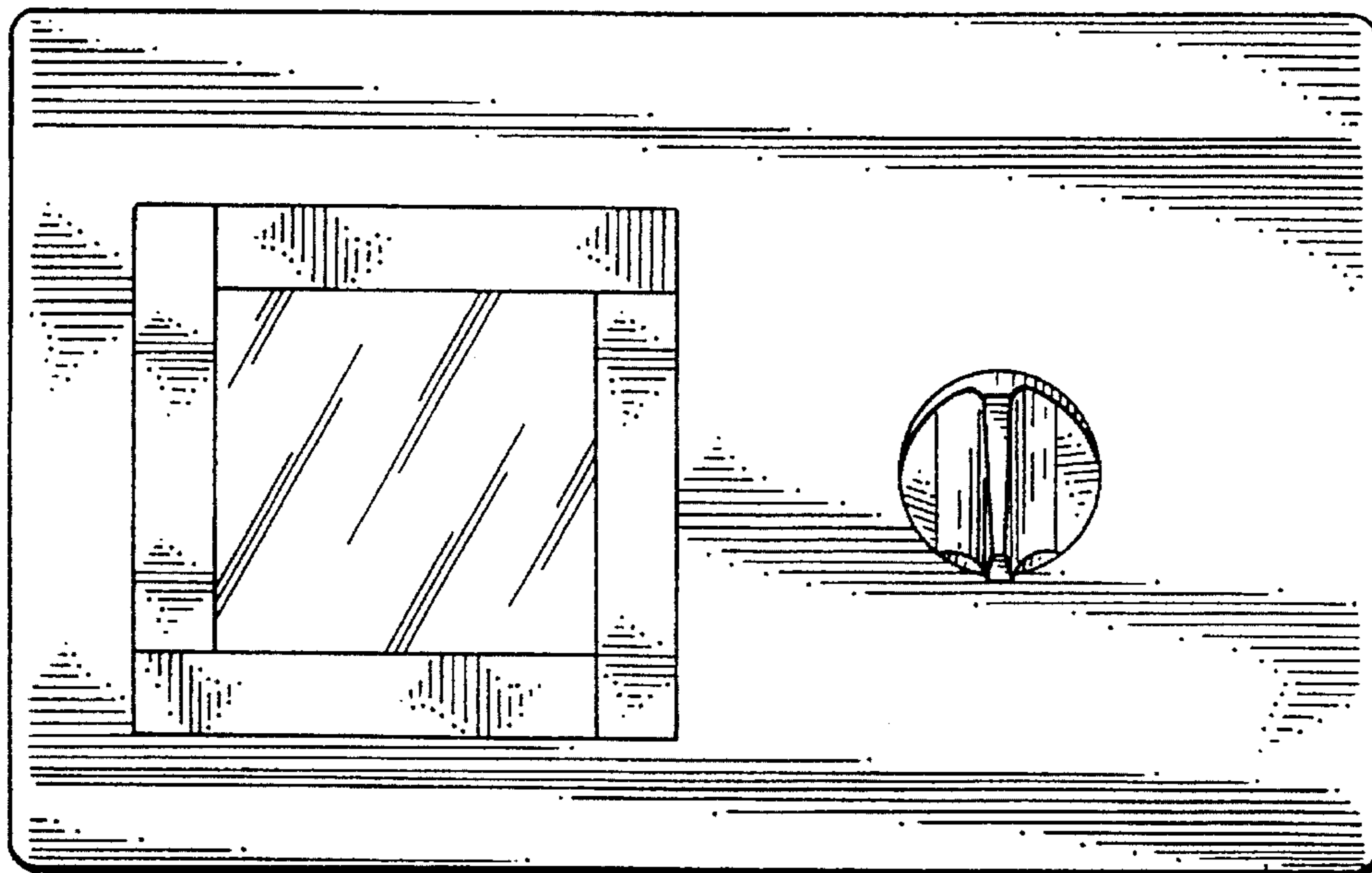

FIG. 3

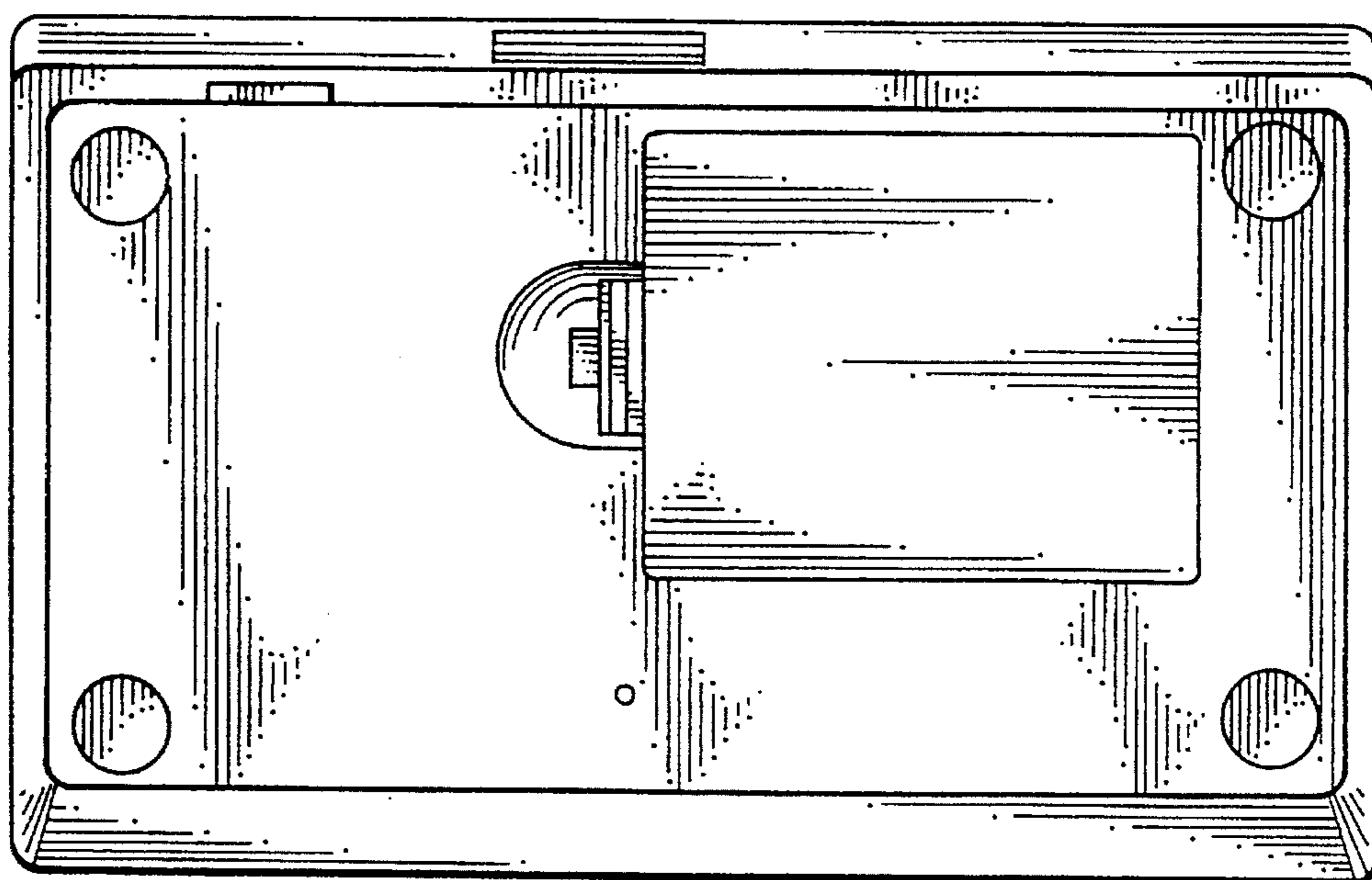

FIG. 4

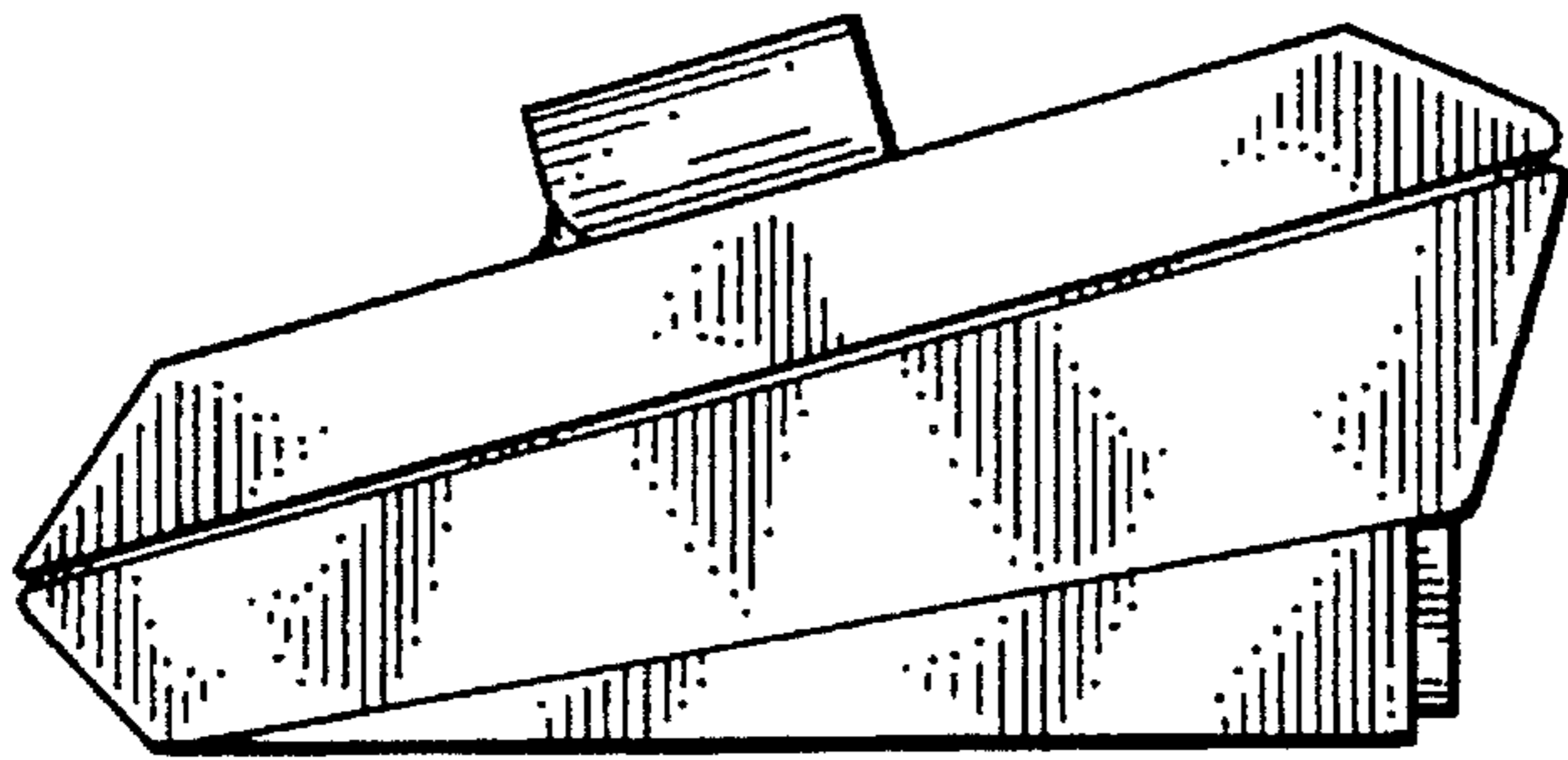

FIG. 5

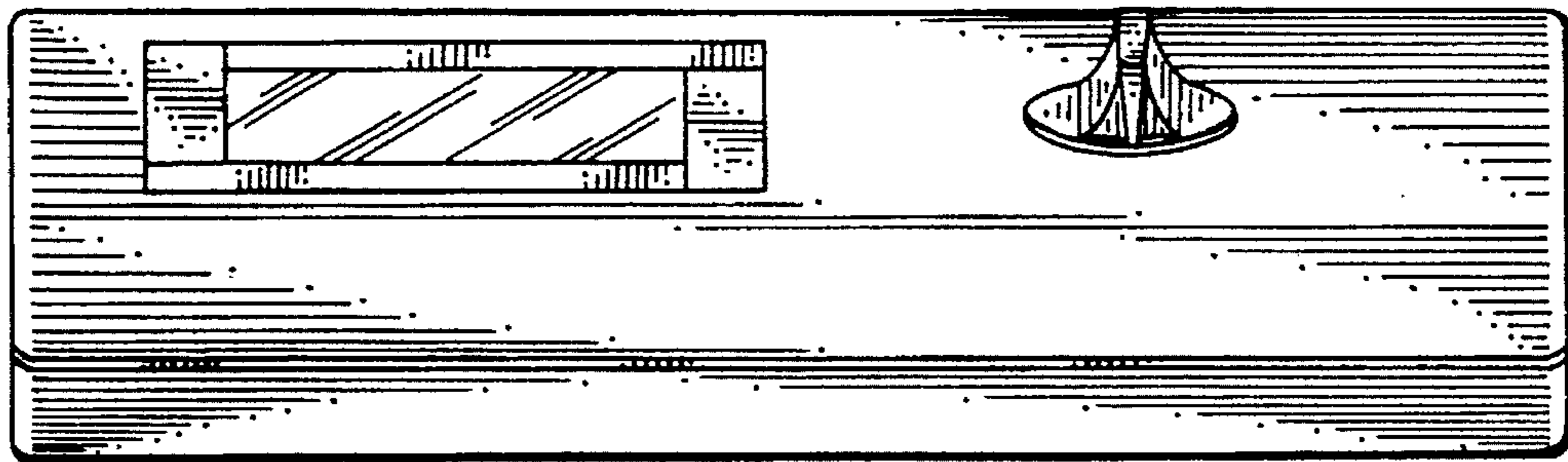

FIG. 6

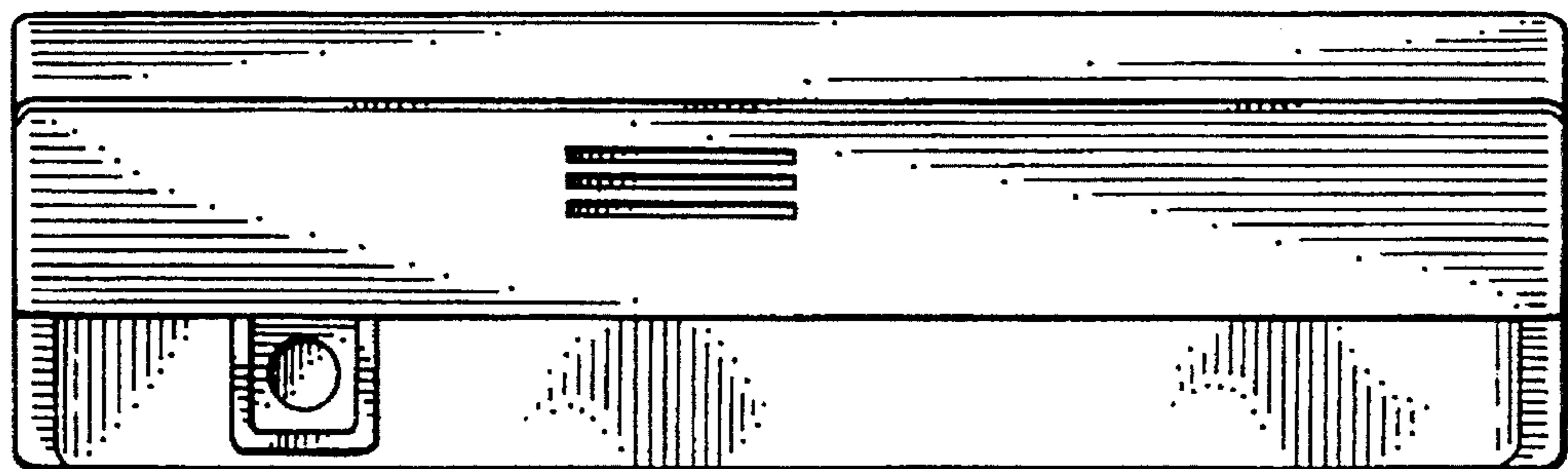

FIG. 7