



US00D368179S

United States Patent [19]

Brunner et al.

[11] Patent Number: **Des. 368,179**

[45] Date of Patent: ****Mar. 26, 1996**

[54] **BED**

[75] Inventors: **Merlin A. Brunner**, Appleton; **Harvey J. Draheim**, Weyauwega, both of Wis.

[73] Assignee: **Simmons Juvenile Products Company, Inc.**, New London, Wis.

[**] Term: **14 Years**

[21] Appl. No.: **29,246**

[22] Filed: **Sep. 30, 1994**

[52] U.S. Cl. **D6/395**

[58] Field of Search D6/382, 383, 389-395, D6/505-508; 5/239, 240, 279.1, 53.1

[56] **References Cited**

U.S. PATENT DOCUMENTS

D. 55,928	8/1920	Brown	D6/391
D. 90,386	7/1933	Shaw	D6/394 X
D. 101,221	9/1936	Jiranek	D6/393
357,823	5/1995	Bellows et al.	D6/395

OTHER PUBLICATIONS

Best, p. 456, bed #54 at top right.
J. C. Penney, Spring/summer 1992, p. 999, bed #C at lower right.

Simmons Little Folks ©1993, #0705.

Simmons Juvenile Products Company, Inc. 1990 Catalog: Dresser Base 0704.

Primary Examiner—Janice E. Seeger
Attorney, Agent, or Firm—Hoffmann & Baron

[57] **CLAIM**

The ornamental design for a bed, as shown and described.

DESCRIPTION

FIG. 1 is a front perspective view of a bed showing our new design;

FIG. 2 is a top plan view thereof;

FIG. 3 is a front elevation view thereof;

FIG. 4 is a side elevation view thereof, the opposite side being a mirror image thereof;

FIG. 5 is an enlarged sectional view taken along lines 5—5 of FIG. 3;

FIG. 6 is an enlarged section view taken along lines 6—6 of FIG. 3, and,

FIG. 7 is an enlarged section view taken along lines 7—7 of FIG. 3.

1 Claim, 5 Drawing Sheets

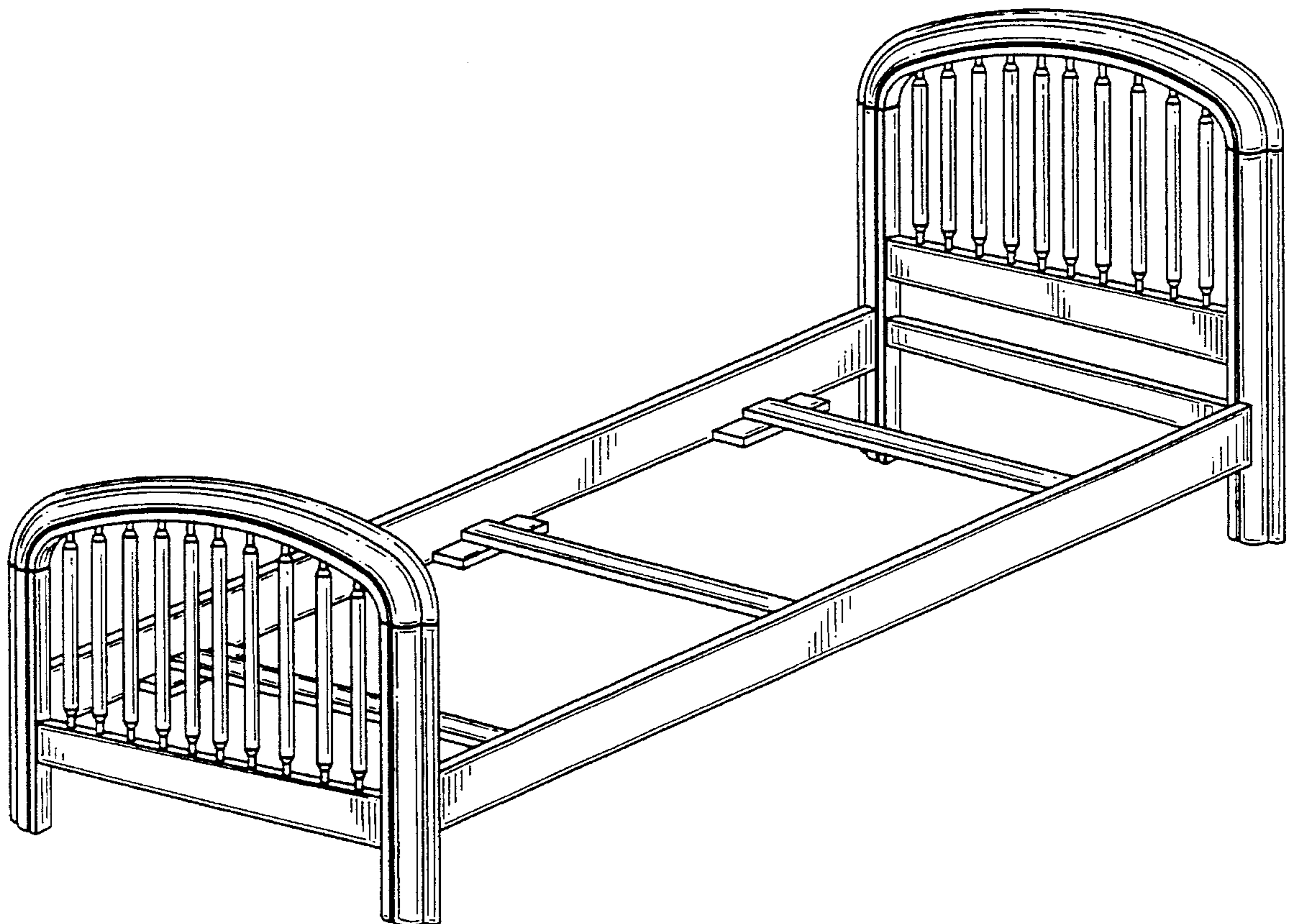

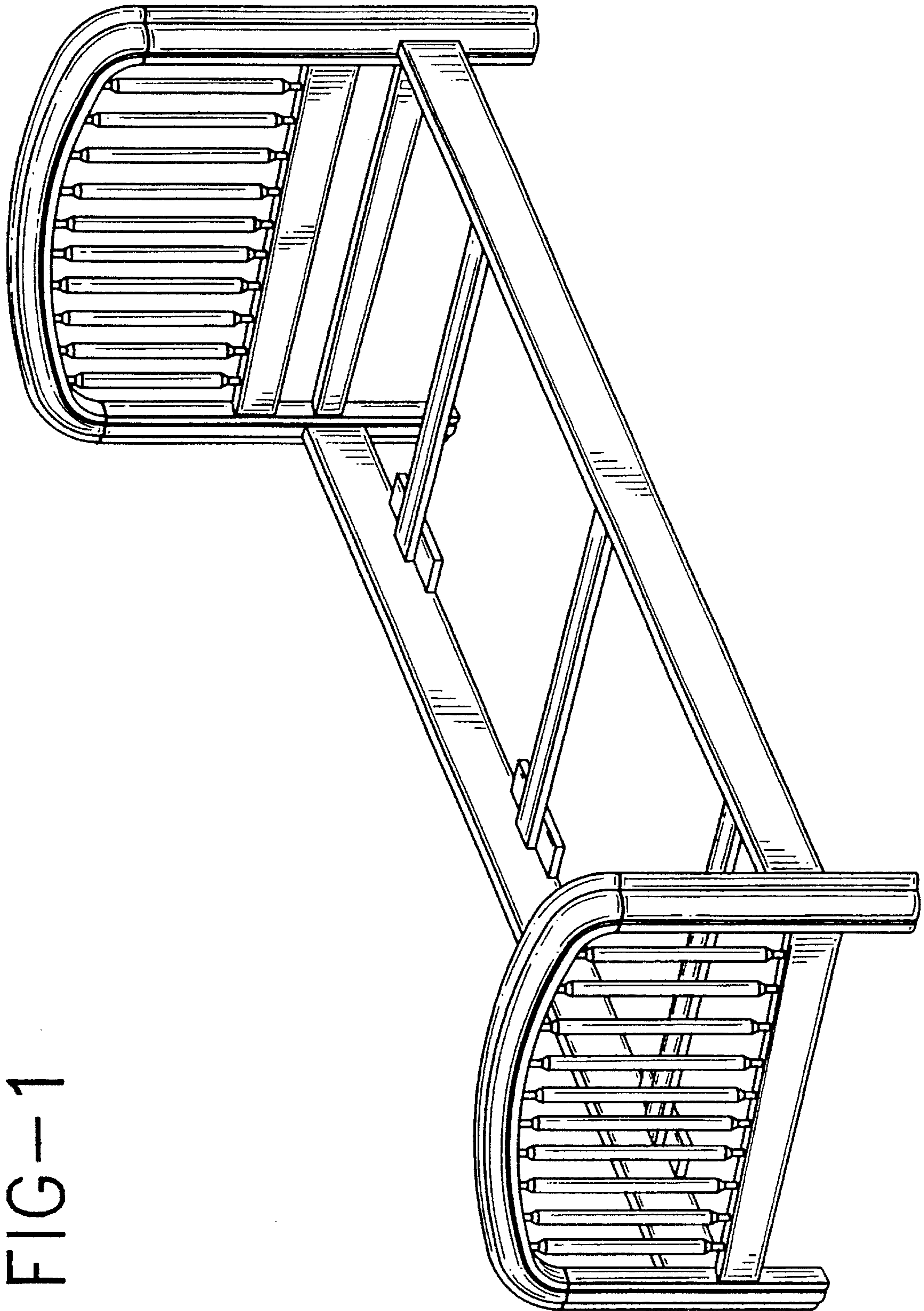

FIG-1

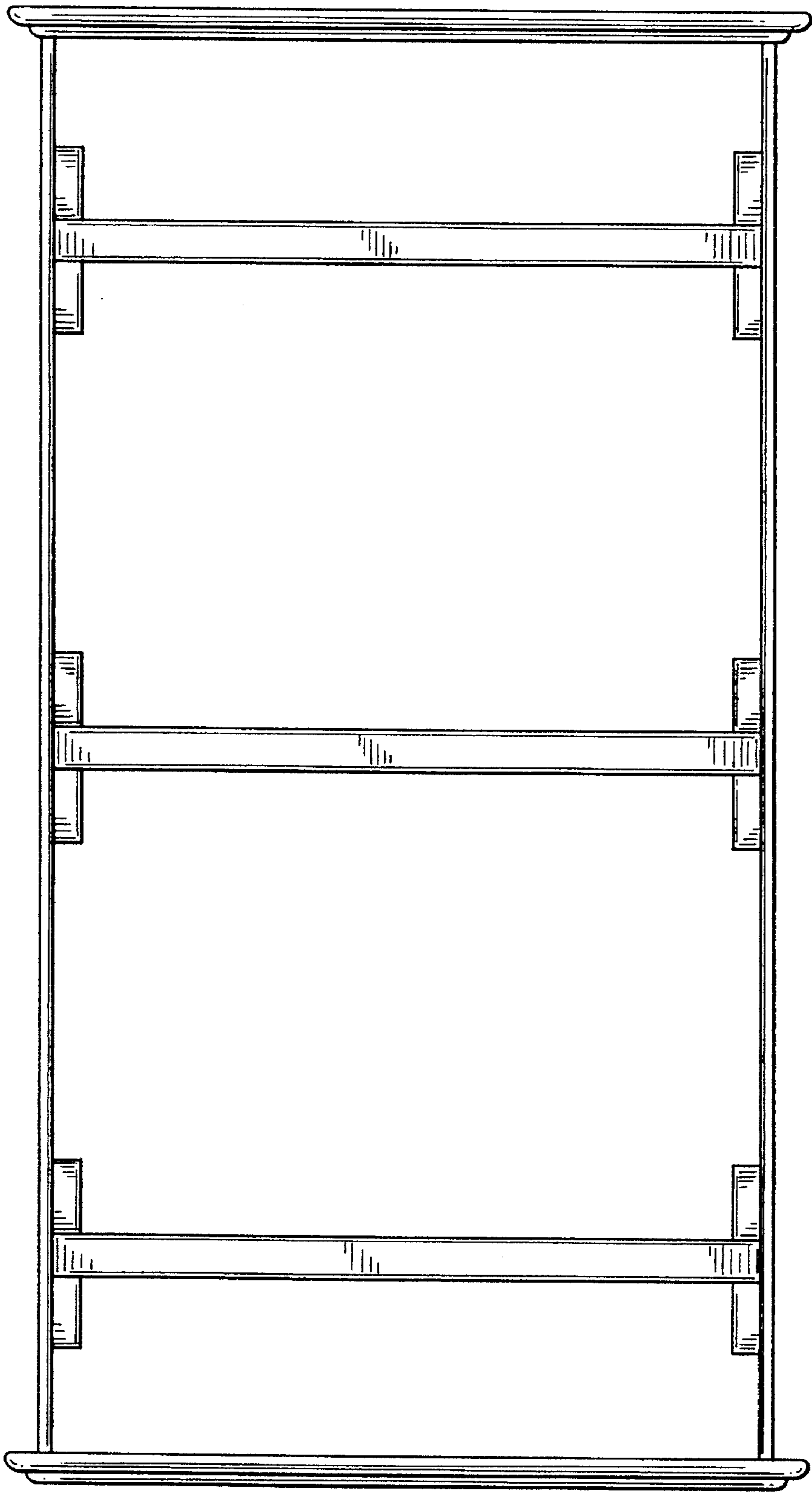
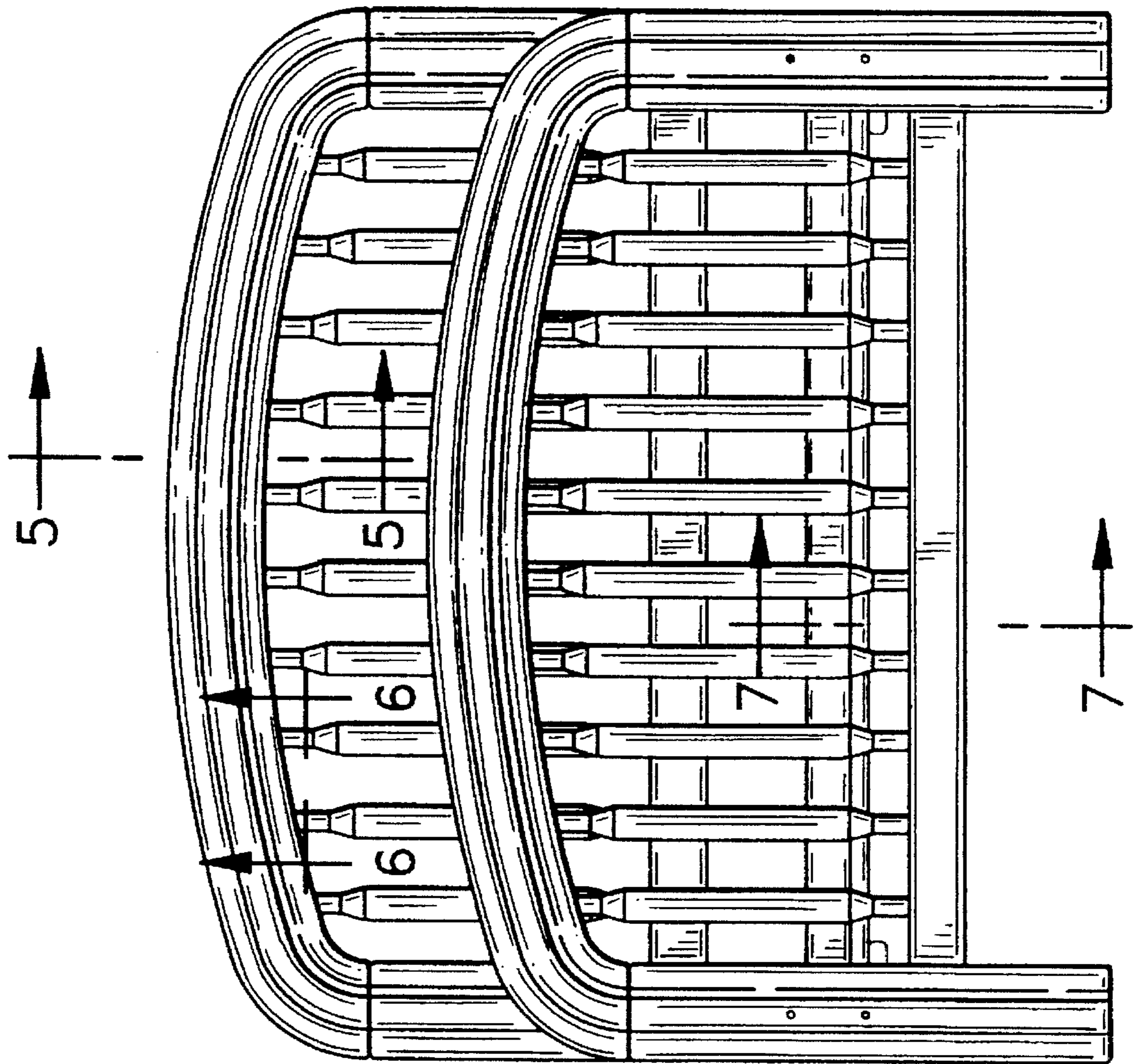

FIG-2

FIG-3



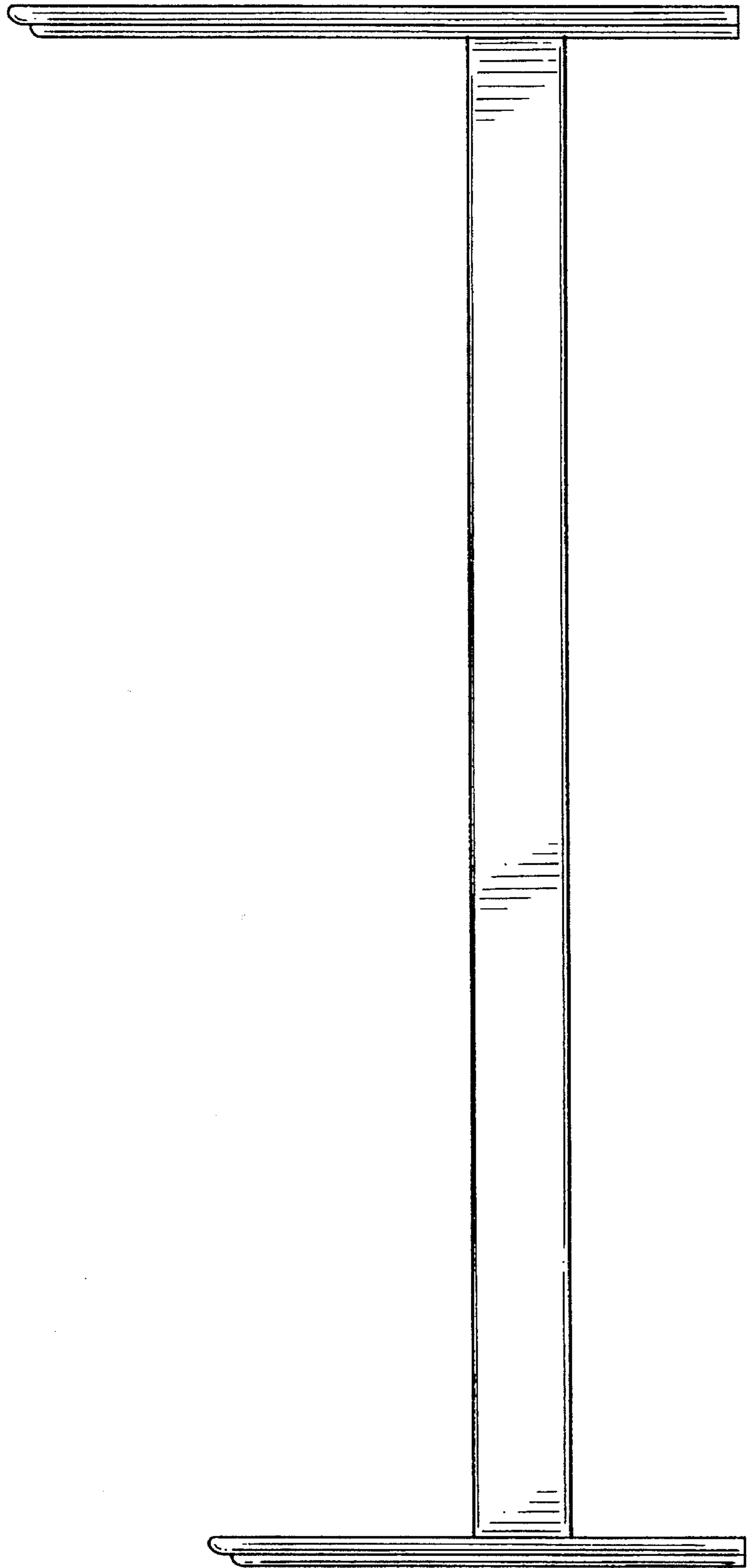

FIG-4

FIG-5

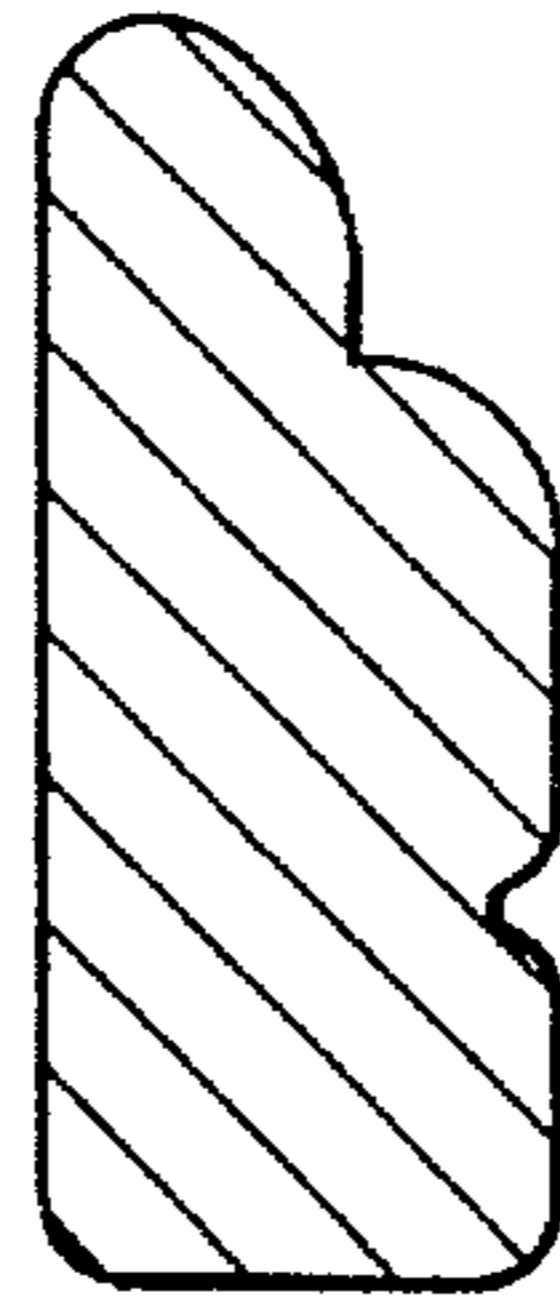

FIG-6

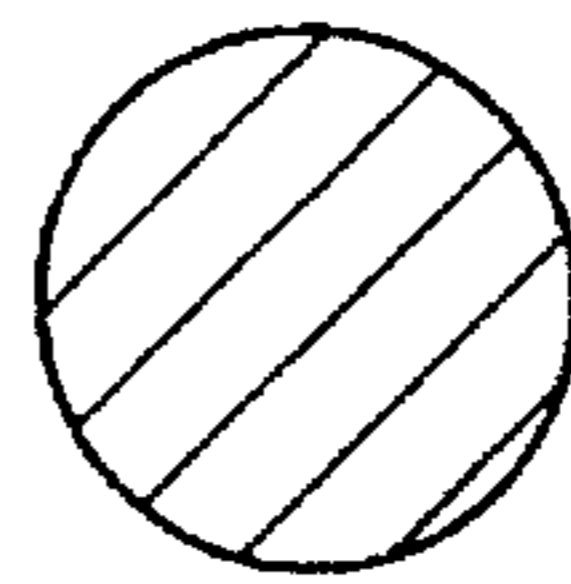

FIG-7

