



US00D368097S

United States Patent [19]

[11] Patent Number: **Des. 368,097**

Heberling et al.

[45] Date of Patent: ****Mar. 19, 1996**

[54] **MODEM**

[75] Inventors: **James R. Heberling**, Lawrenceville;
Samuel W. Harris, Norcross, both of Ga.

[73] Assignee: **Hayes Microcomputer Products, Inc.**, Norcross, Ga.

[**] Term: **14 Years**

[21] Appl. No.: **39,728**

[22] Filed: **Jun. 5, 1995**

[52] U.S. Cl. **D14/242; D14/107**

[58] **Field of Search** D14/100, 107, D14/114, 242, 240, 140; D21/13, 48; D13/164, 184; 174/50, 52.1; 375/222; 379/93, 96, 419, 420, 428, 440, 441, 442; 361/679, 683, 686, 724, 728, 730, 752

[56] **References Cited**

U.S. PATENT DOCUMENTS

D. 262,106	12/1981	Frassanito	D14/107
D. 292,600	11/1987	Wagner	D21/48
D. 293,319	12/1987	Matsuda et al.	D14/241
D. 296,440	6/1988	Smith et al.	D14/107
D. 301,877	6/1989	Greenberg et al.	D14/107

D. 302,268	7/1989	Larson et al.	D14/240 X
D. 309,731	8/1990	Takai	D14/107
D. 354,752	1/1995	Johnson et al.	D14/242 X
D. 359,287	6/1995	Heberling et al.	D14/242
D. 361,570	8/1995	Harris et al.	D14/242
4,939,623	7/1990	Equi et al.	361/686 X

Primary Examiner—Jeffrey Asch
Attorney, Agent, or Firm—Jones & Askew

[57] **CLAIM**

The ornamental design for a moden, as shown and described.

DESCRIPTION

FIG. 1 is a perspective view of a modem embodying our new design;
FIG. 2 is a front elevational view thereof;
FIG. 3 is a left side elevational view thereof;
FIG. 4 is a right side elevational view thereof;
FIG. 5 is a rear elevational view thereof;
FIG. 6 is a top plan view thereof;
FIG. 7 is a bottom plan view thereof; and,
FIG. 8 is a right side elevational view of an alternative embodiment of our new design for which the other views are identical to those shown in FIGS. 1-3 and 5-7 inclusive.

1 Claim, 4 Drawing Sheets

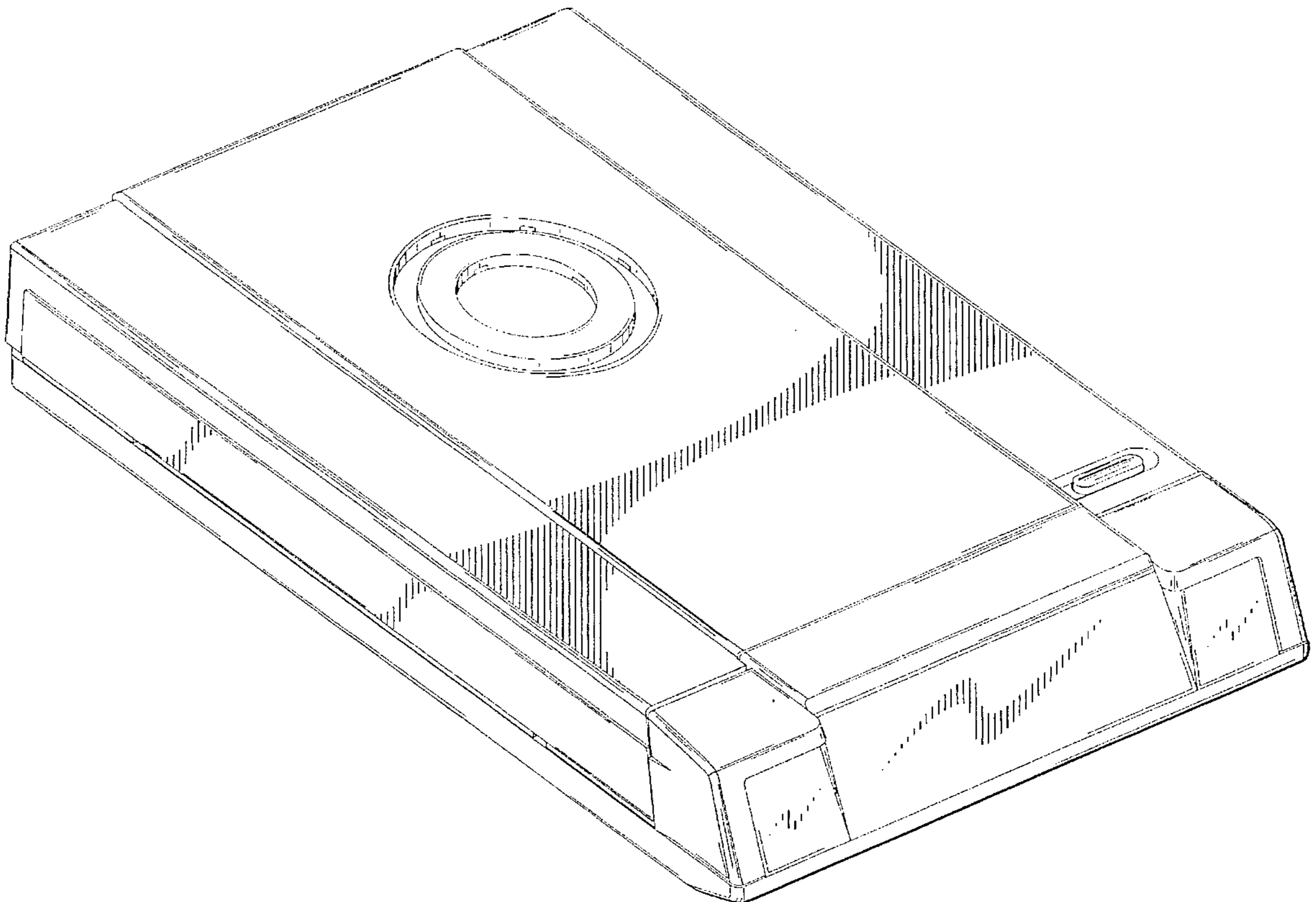

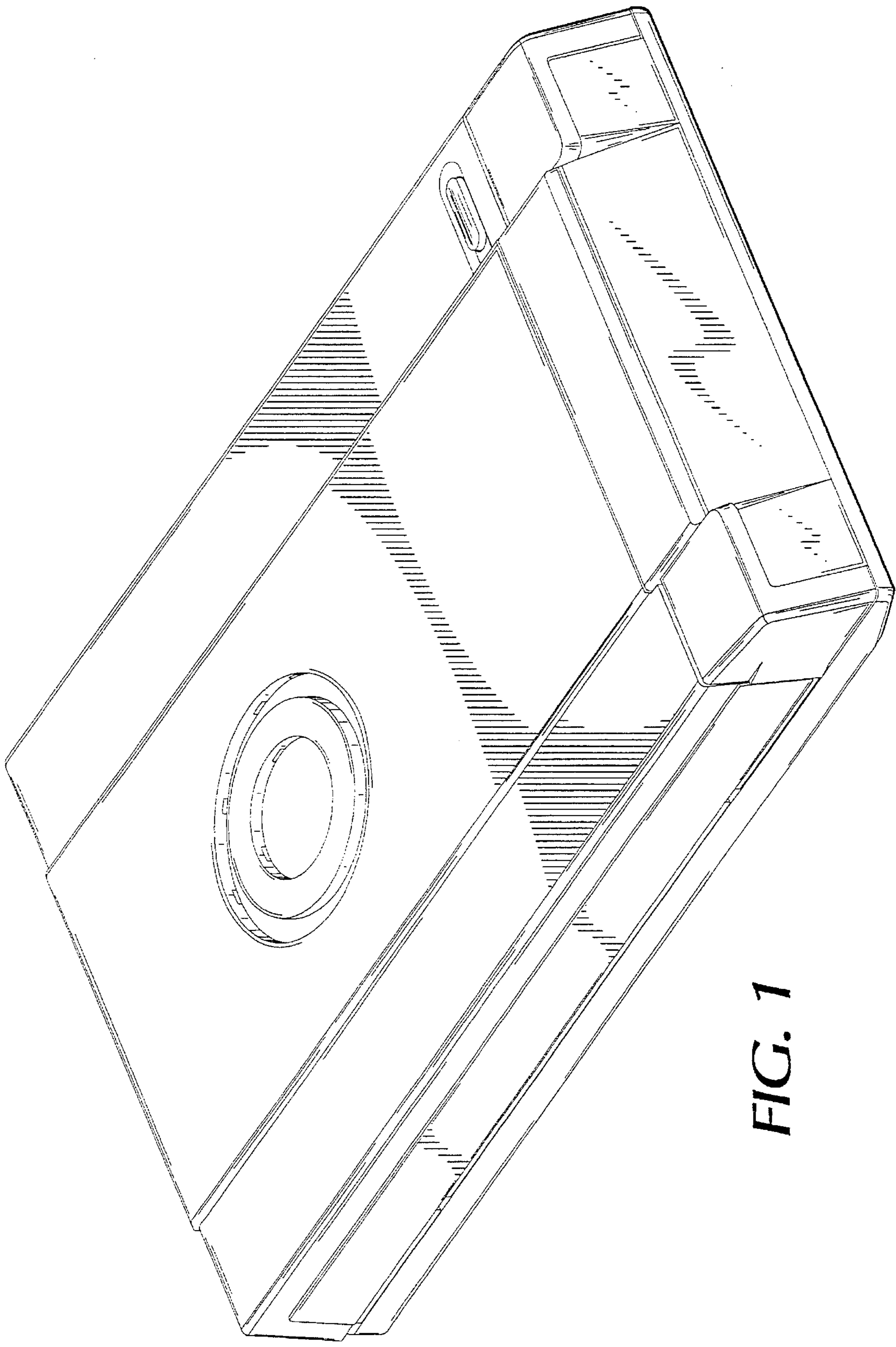

FIG. 1

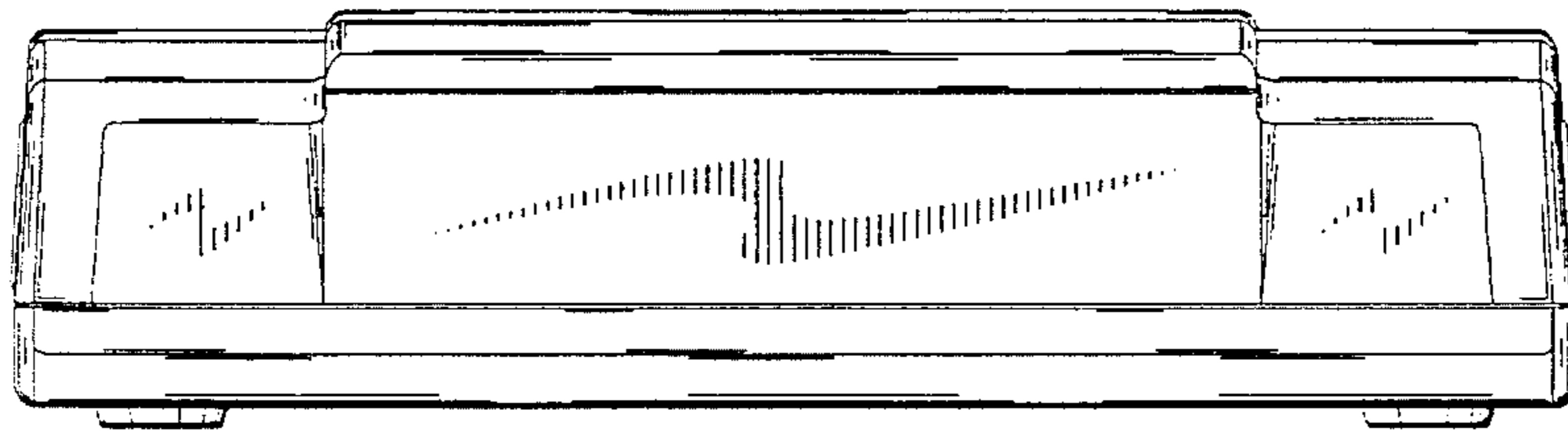

FIG. 2

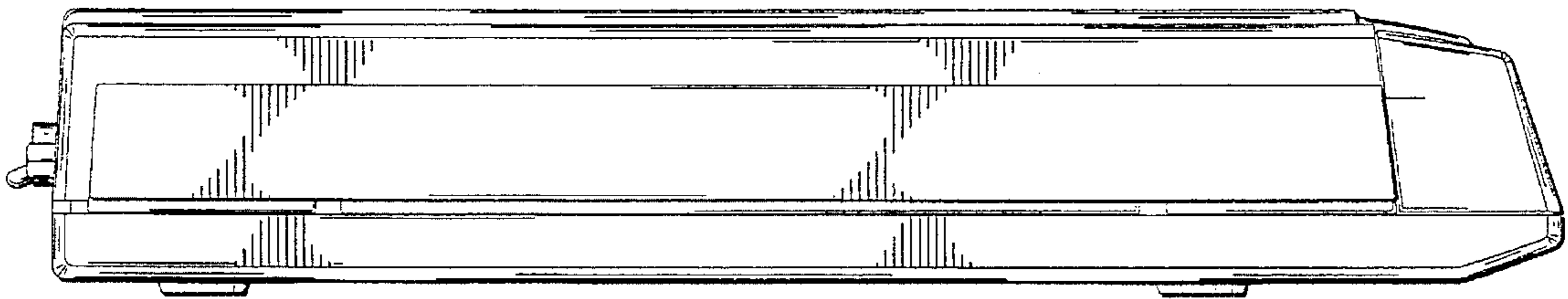

FIG. 3

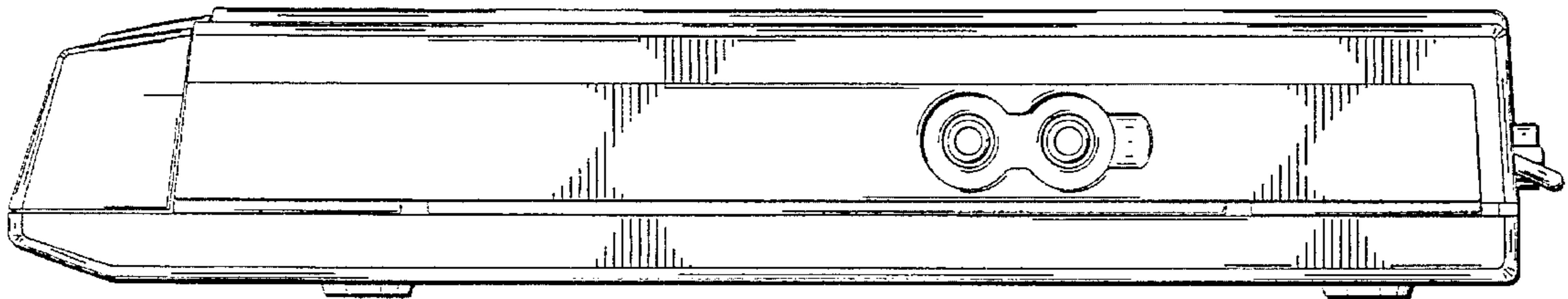

FIG. 4

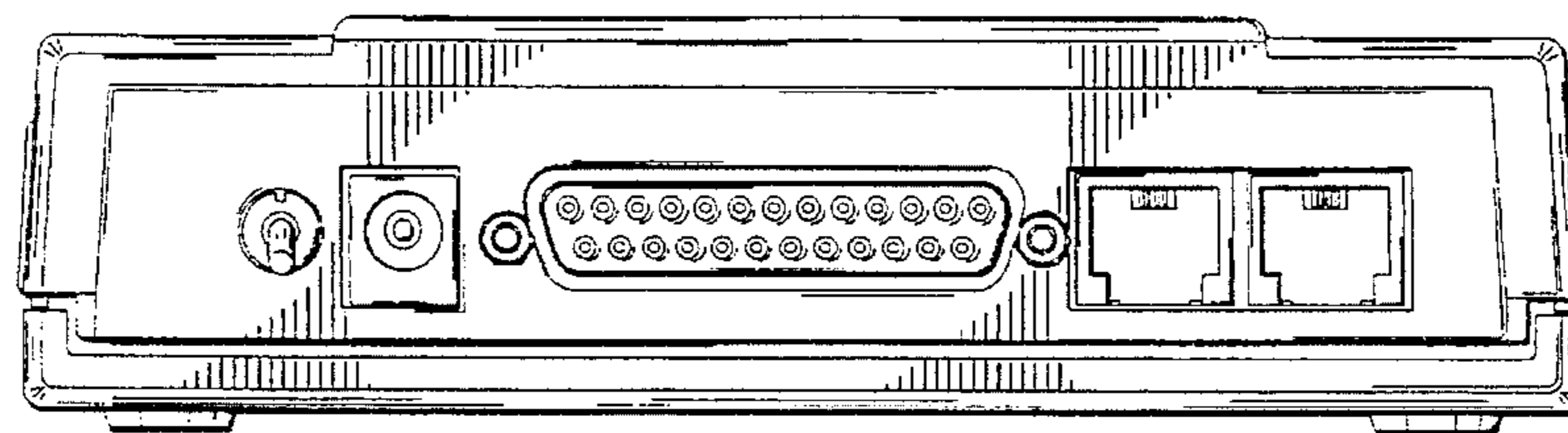

FIG. 5

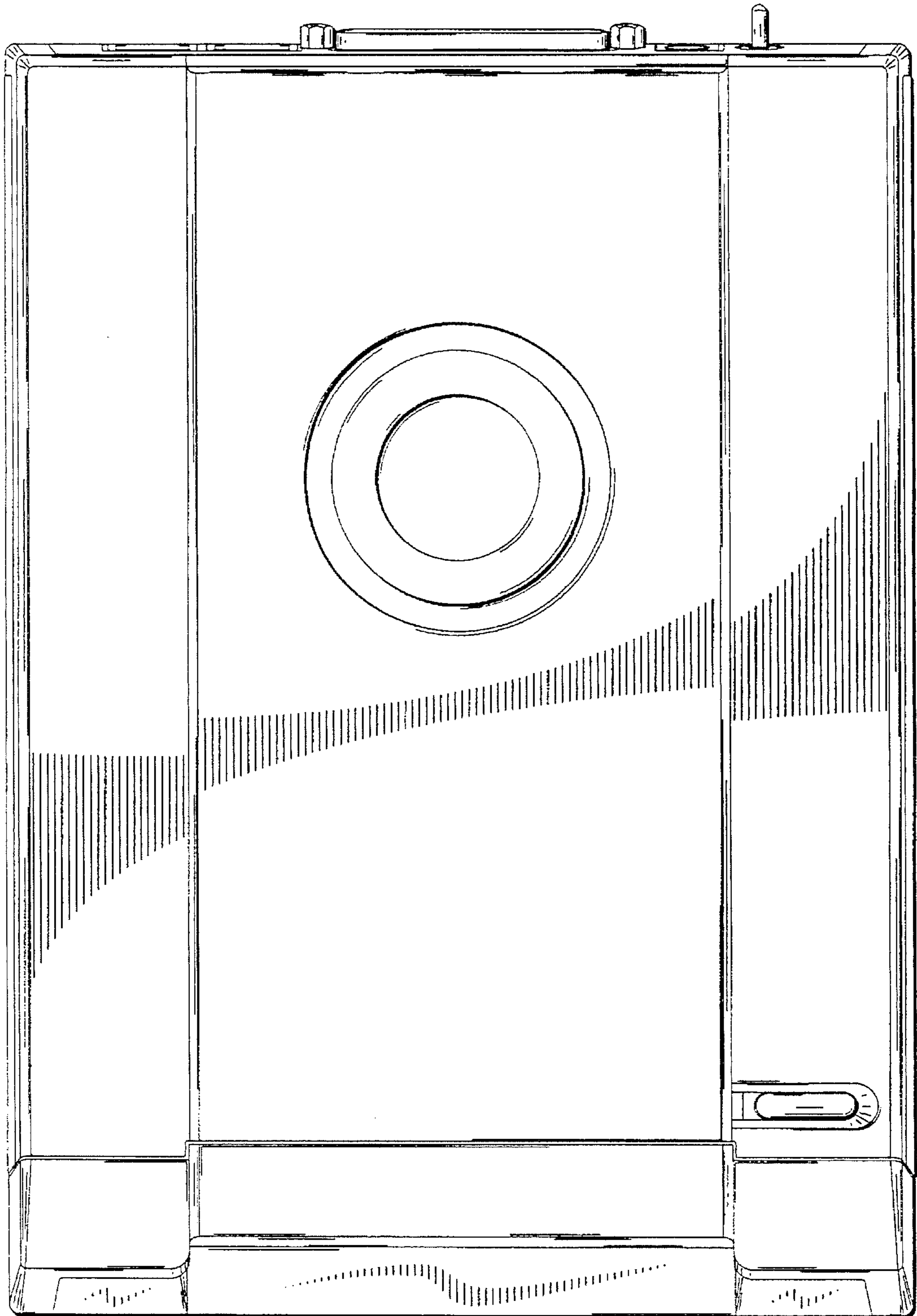

FIG. 6

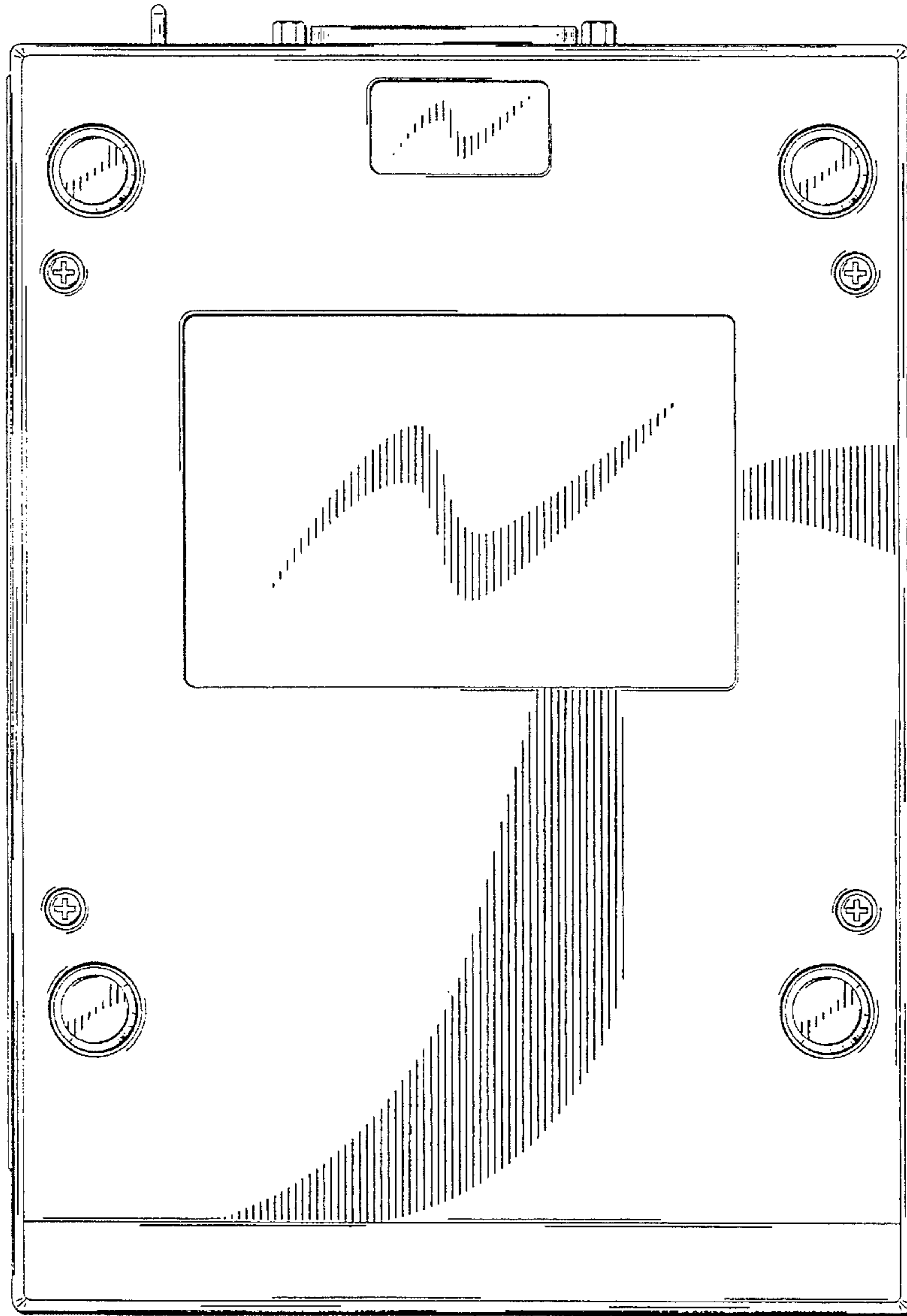

FIG. 7

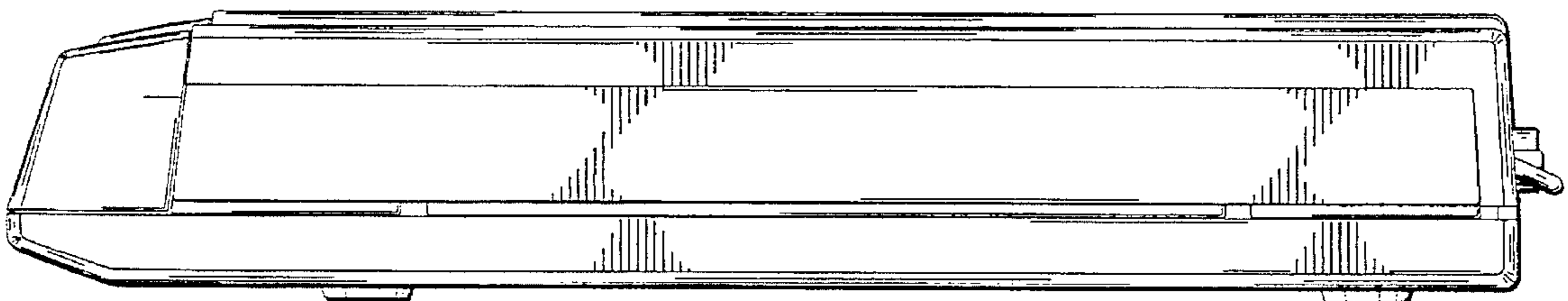

FIG. 8