



US00D367956S

United States Patent [19]

Peters

[11] Patent Number: **Des. 367,956**

[45] Date of Patent: ****Mar. 19, 1996**

[54] **POCKETBOOK**

[75] Inventor: **Jean Peters**, New York, N.Y.

[73] Assignee: **B. H. Smith, Inc.**, New York, N.Y.

[**] Term: **14 Years**

[21] Appl. No.: **32,632**

[22] Filed: **Dec. 22, 1994**

[52] U.S. Cl. **D3/233; D3/232**

[58] Field of Search 190/107, 109, 190/111, 112, 116; 150/100, 106, 107, 110, 112, 114, 116, 117, 132, 143, 145, 147; D3/201, 218, 221, 224, 225, 226, 230, 232, 245-247, 249-252, 253, 273-276, 283-287, 289, 290, 301, 303, 318, 319, 323, 324, 326, 327; 206/38, 305, 320; 383/13, 35, 38, 40, 84, 86, 110; 224/205, 209, 224

[56] **References Cited**

U.S. PATENT DOCUMENTS

D. 318,951	8/1991	Stricklin	D3/287
D. 343,951	2/1994	Petty et al.	D3/249
D. 345,254	3/1994	Bodden	D3/246

2,621,696	12/1952	Barnes	150/112 X
4,907,634	3/1990	Yoo	150/143 X
5,002,401	3/1991	Blackman	190/109 X

Primary Examiner—Louis S. Zarfes
Assistant Examiner—Monica A. Hannon
Attorney, Agent, or Firm—Collard & Roe

[57] **CLAIM**

The ornamental design for a pocketbook, as shown and described.

DESCRIPTION

FIG. 1 is a front, top, right side perspective view of the pocketbook according to the invention, with one of the front flaps open;
FIG. 2 is a front, top left side perspective view of the pocketbook with the front flap and pocket open;
FIG. 3 is a front view thereof;
FIG. 4 is a top plan view thereof;
FIG. 5 is a bottom view thereof;
FIG. 6 is a rear view thereof;
FIG. 7 is the left side view thereof; and,
FIG. 8 is the right side view thereof.

1 Claim, 4 Drawing Sheets

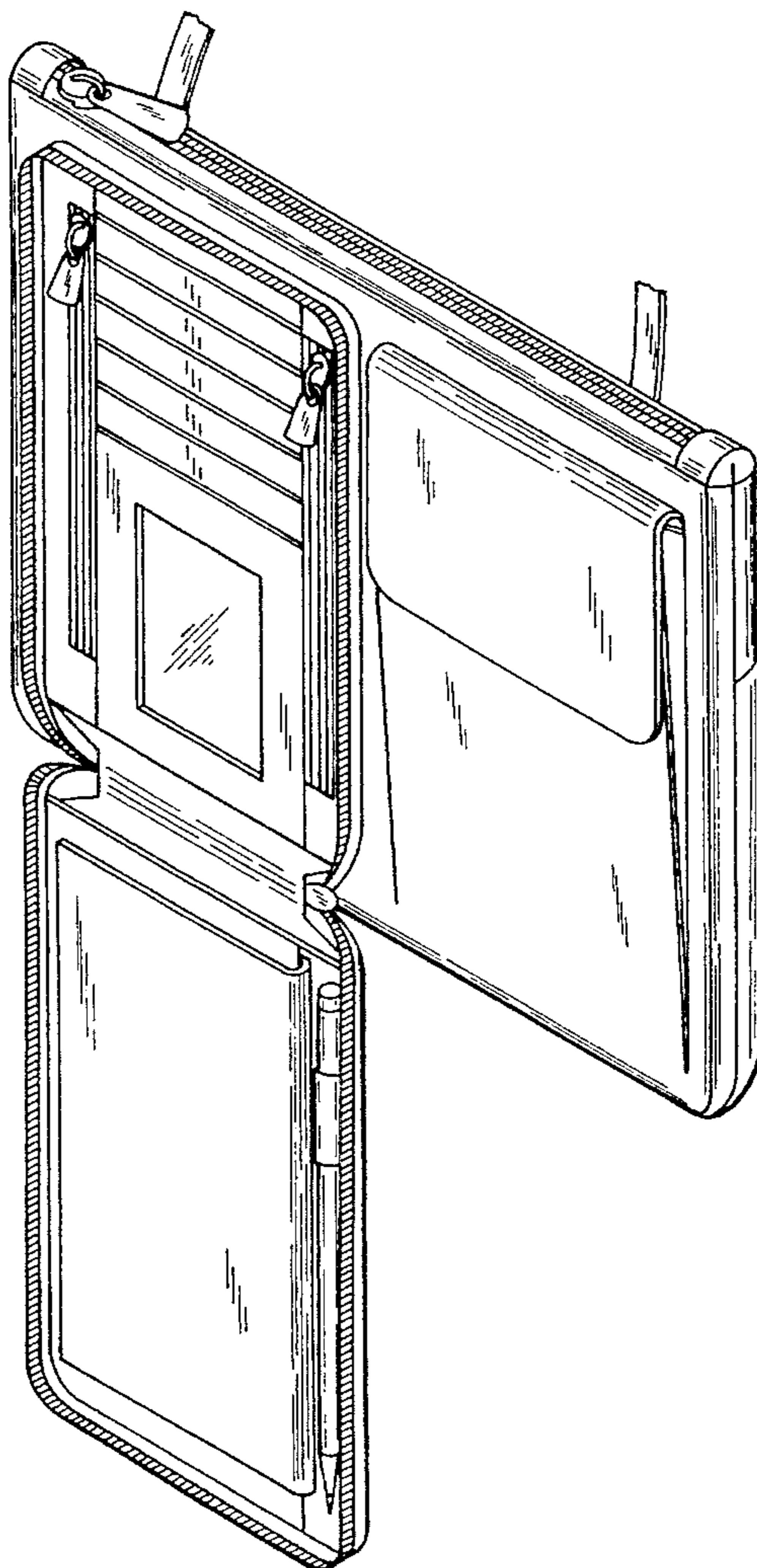

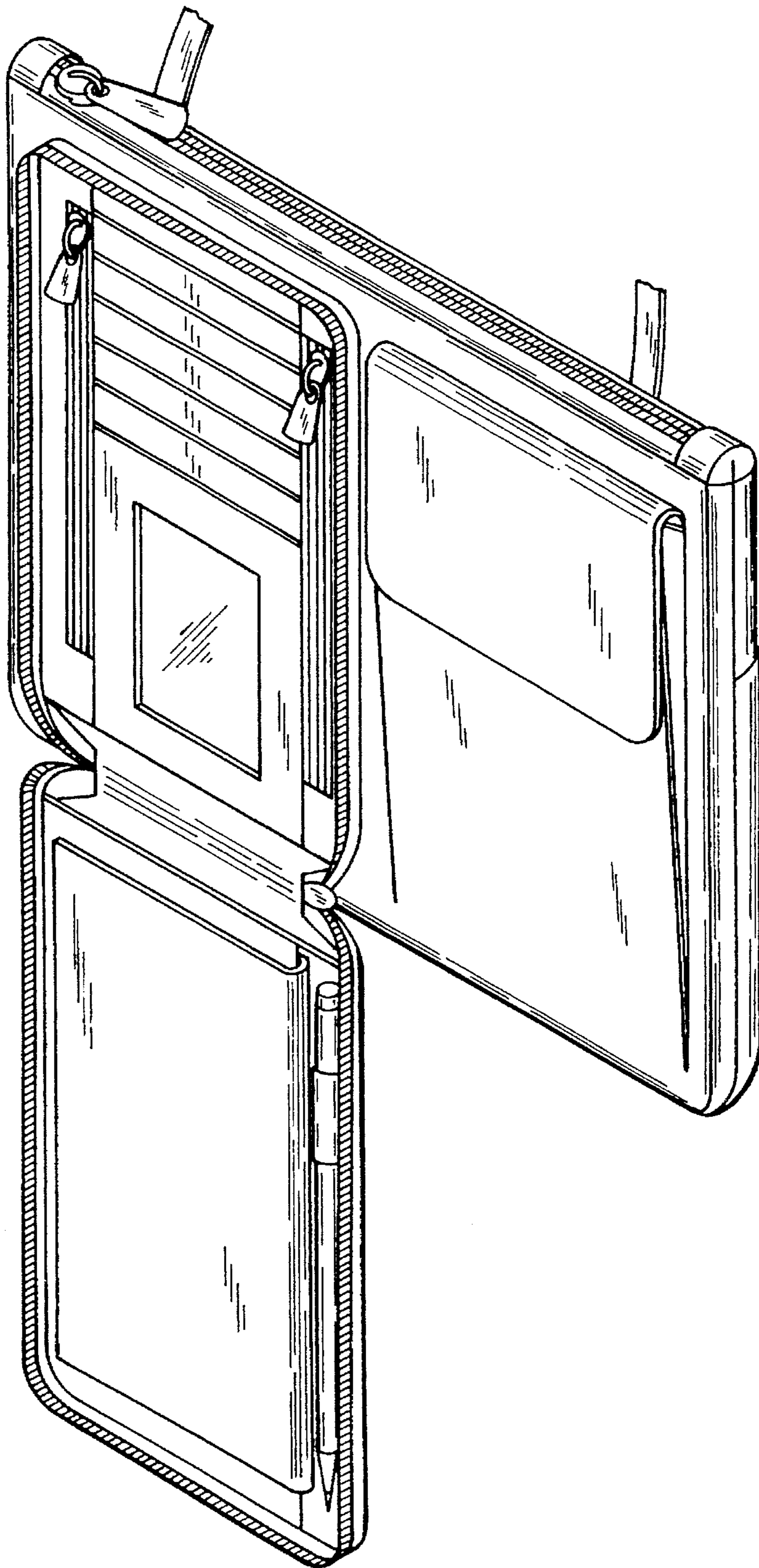

FIG. 1

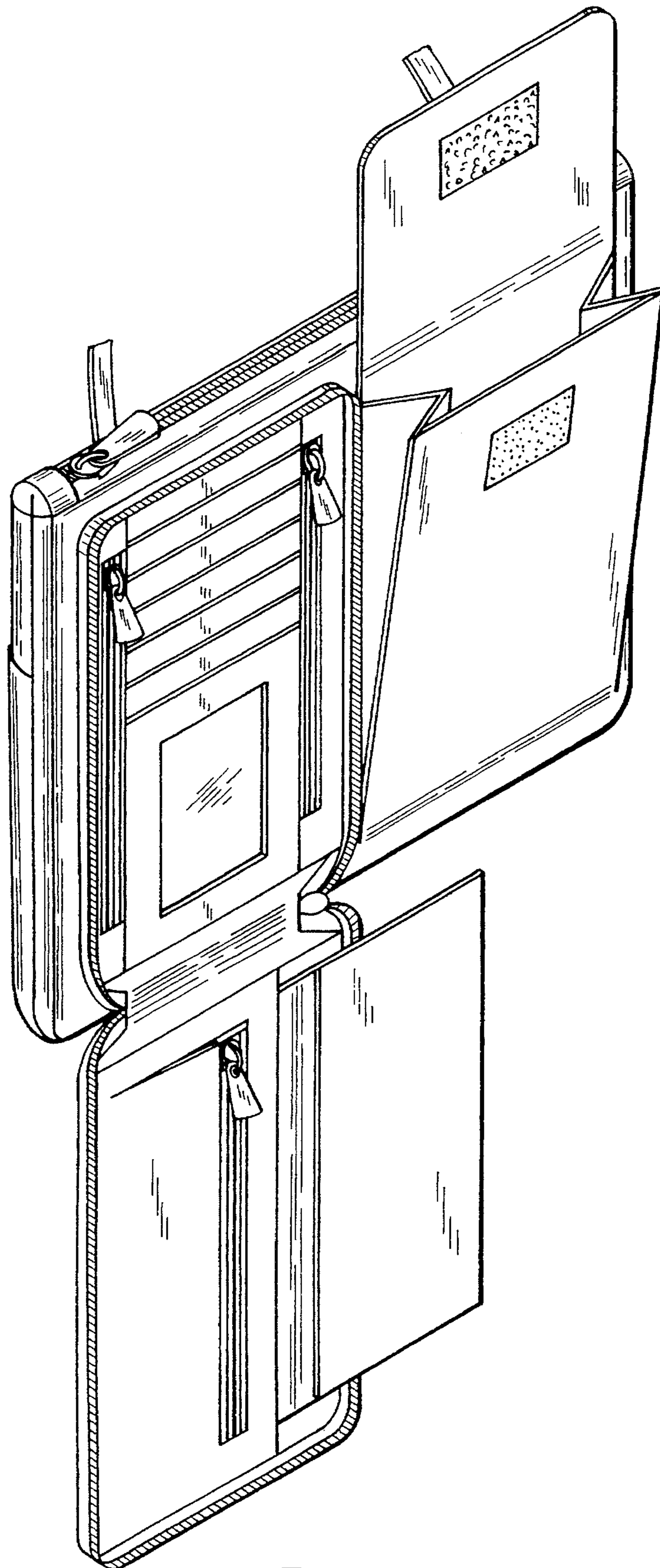

FIG.2

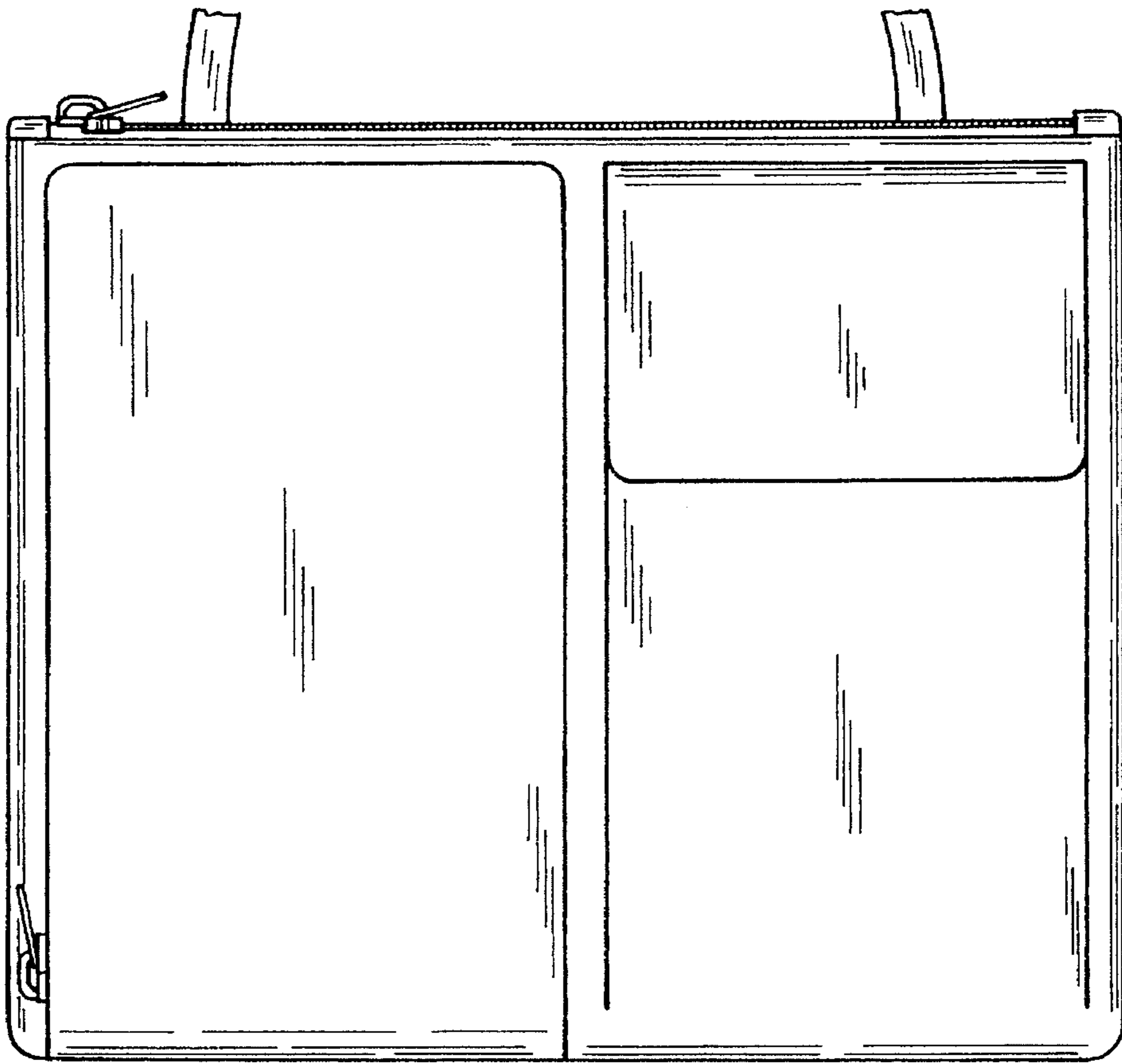

FIG. 3

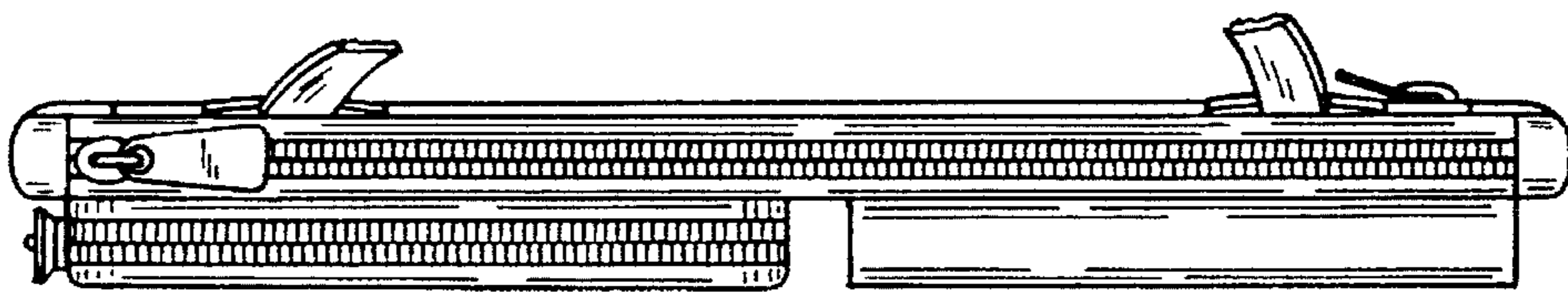

FIG. 4

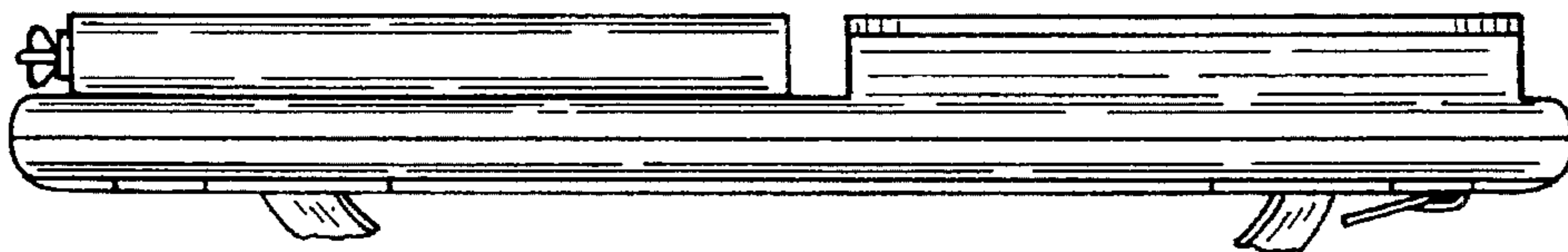

FIG. 5

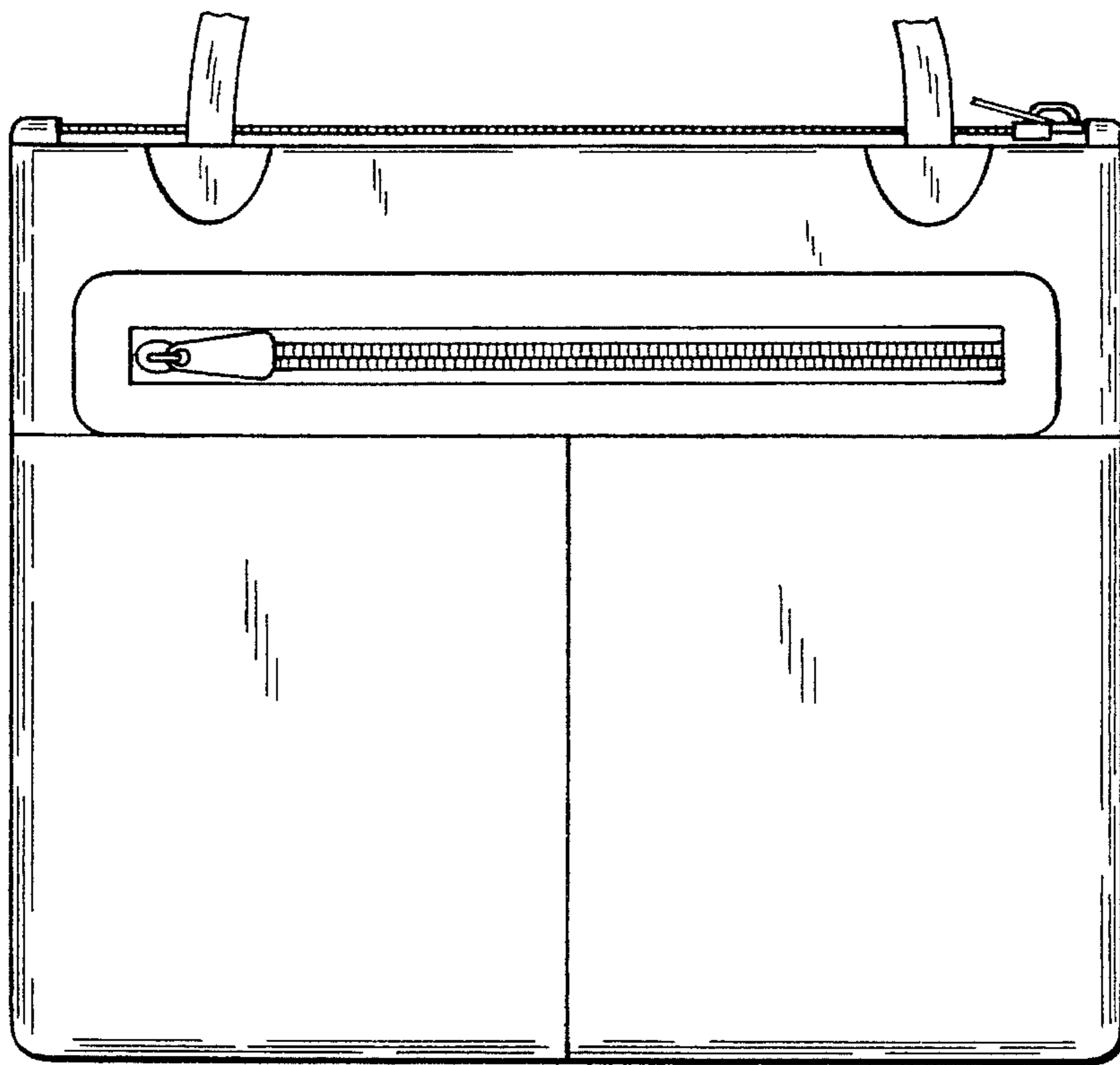

FIG. 6

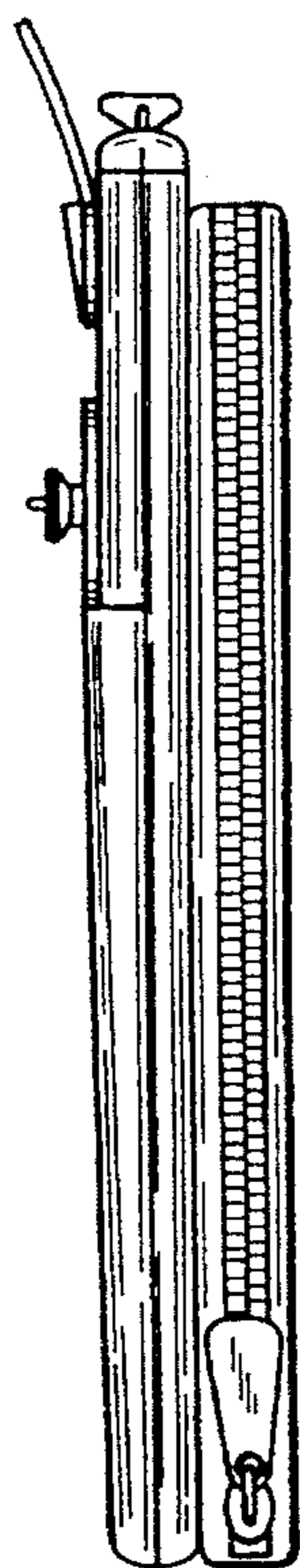

FIG. 7

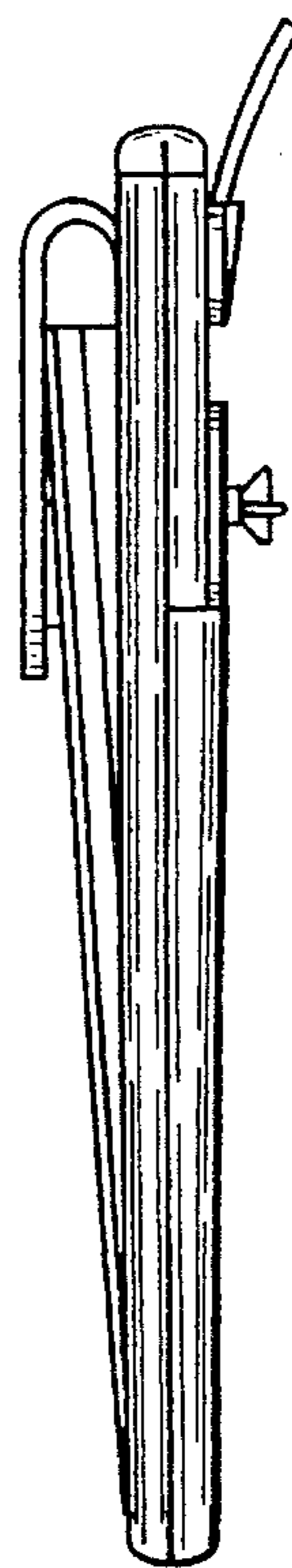

FIG. 8