



US00D367938S

United States Patent [19]

Pickett

[11] Patent Number: **Des. 367,938**

[45] Date of Patent: ****Mar. 12, 1996**

[54] **SUSPENDED LIGHTING FIXTURE**

[75] Inventor: **Mark A. Pickett**, Louisville, Ky.

[73] Assignee: **Thomas Industries, Inc.**, Louisville, Ky.

[**] Term: **14 Years**

[21] Appl. No.: **32,226**

[22] Filed: **Dec. 14, 1994**

[52] U.S. Cl. **D26/91**

[58] Field of Search **D26/72, 80-92; 362/147, 404-408, 367, 351, 355**

[56] **References Cited**

U.S. PATENT DOCUMENTS

- D. 317,214 5/1991 Porter D26/130
- D. 339,208 9/1993 Porter D26/130
- D. 339,653 9/1993 Porter D26/91 X

OTHER PUBLICATIONS

- Kichler Lighting catalog, ©1989, p. 23, Chandelier #K-2597.
- Progress Lighting Catalog, ©1990, p. 52, Chandelier #TC5091-10.

Primary Examiner—Susan J. Lucas
Attorney, Agent, or Firm—Hill, Steadman & Simpson

[57] **CLAIM**

The ornamental design for a suspended lighting fixture, as shown and described.

DESCRIPTION

FIG. 1 is a side elevational view of the suspended lighting fixture of this invention;

FIG. 2 is a side elevational view of the fixture of FIG. 1 showing the fixture rotated from the position of FIG. 1. The opposite side views of FIGS. 1 and 2 would be substantially the same as those figures;

FIG. 3 is a top plan view of the fixture of FIG. 1;

FIG. 4 is a bottom plan view of the fixture of FIG. 1;

FIG. 5 is a view similar to FIG. 1 of a modification of the fixture of FIG. 1;

FIG. 6 is a side elevational view of the fixture of FIG. 5 rotated from the position of FIG. 5. The opposite sides of FIGS. 5 and 6 are substantially identical to the views of FIGS. 5 and 6;

FIG. 7 is a top plan view of the fixture of FIG. 5; and,

FIG. 8 is a bottom plan view of the fixture of FIG. 5.

1 Claim, 6 Drawing Sheets

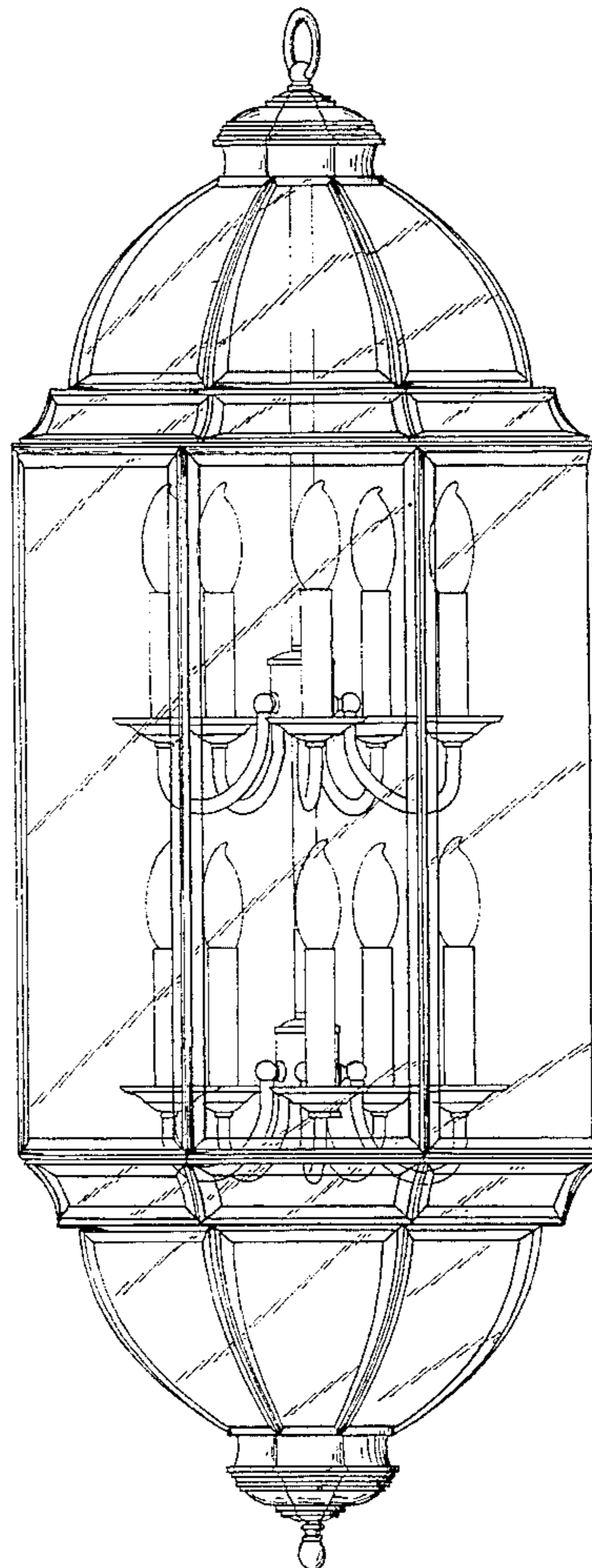
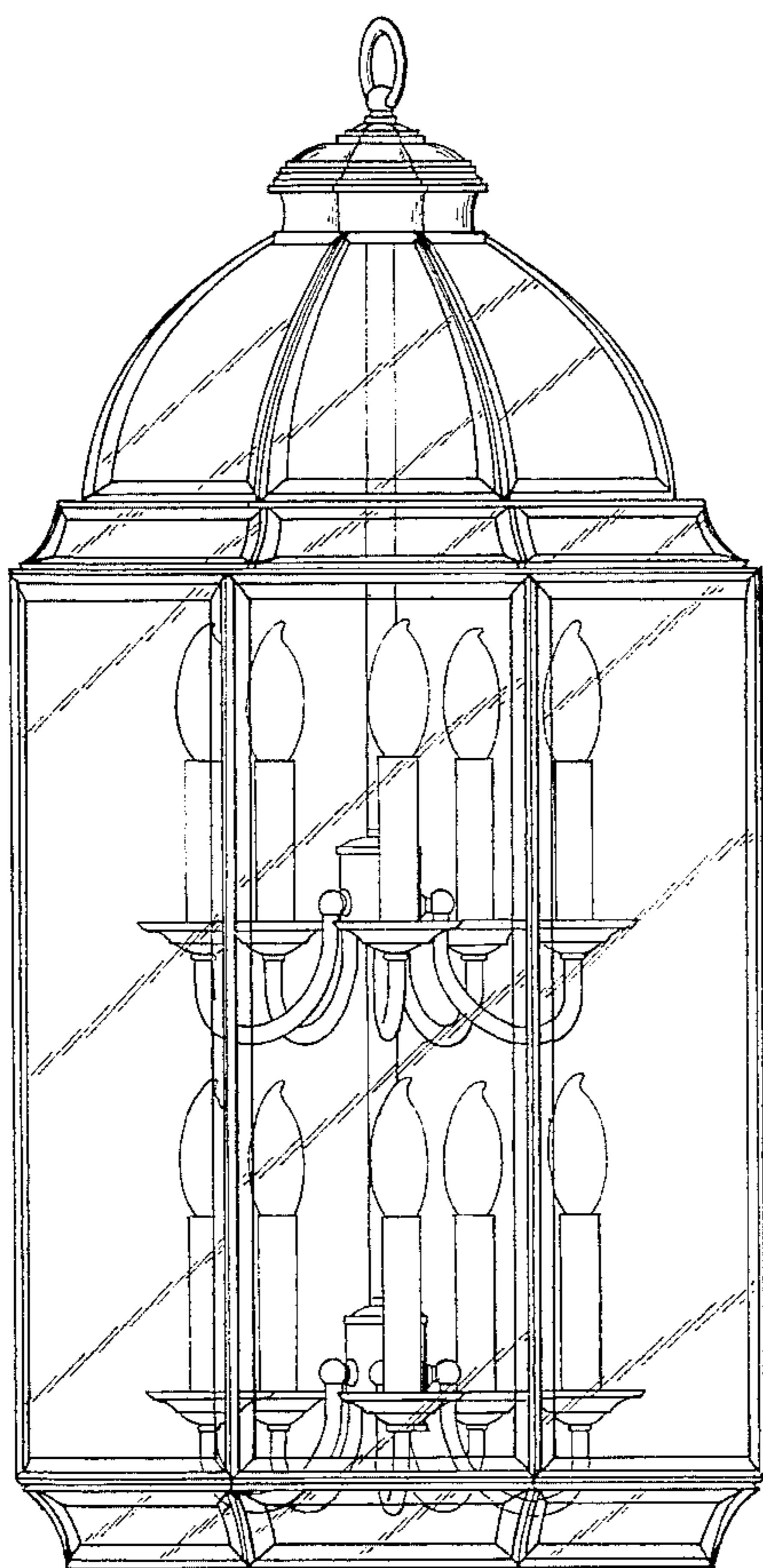

FIG. 1

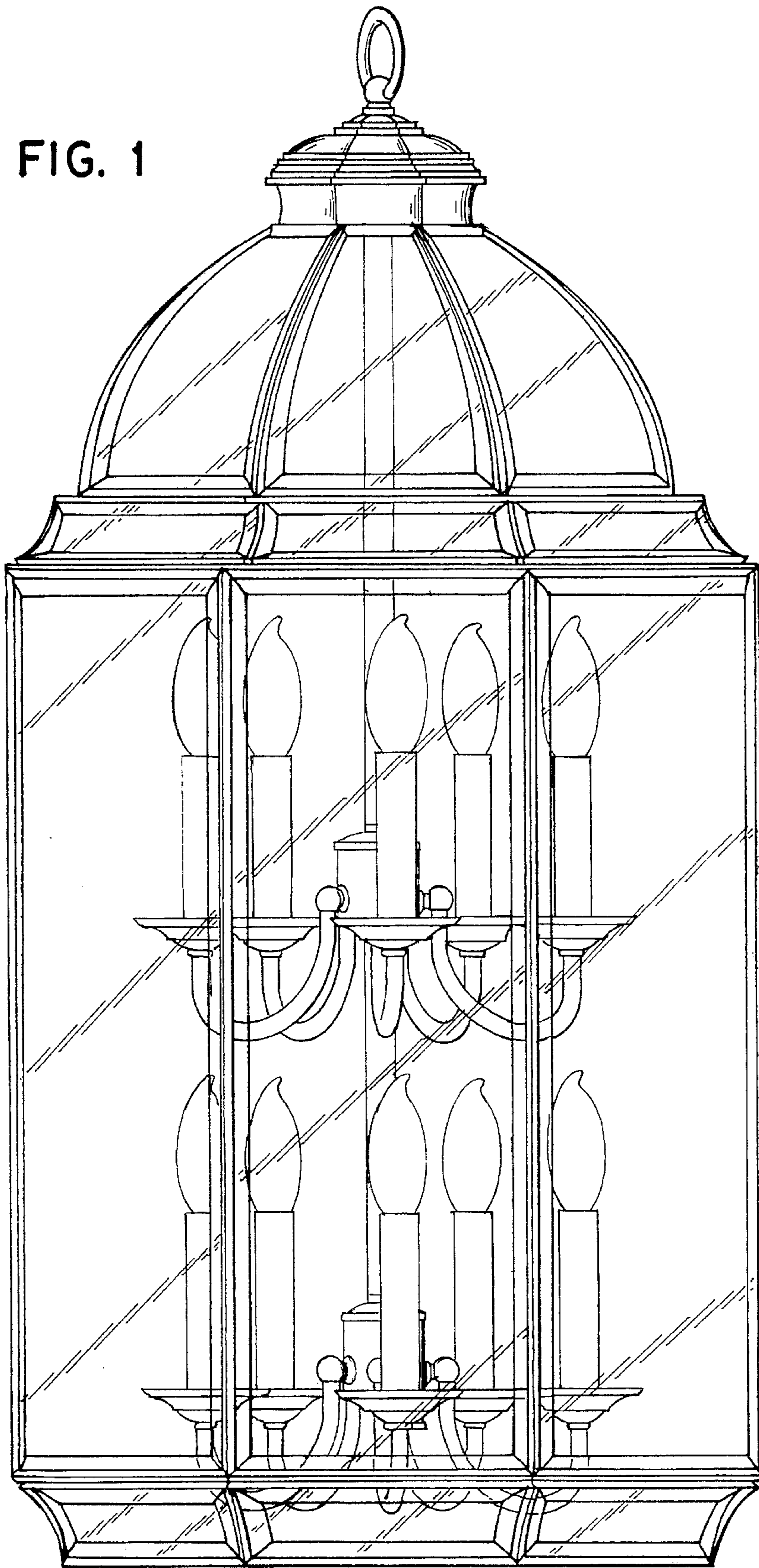

FIG. 2

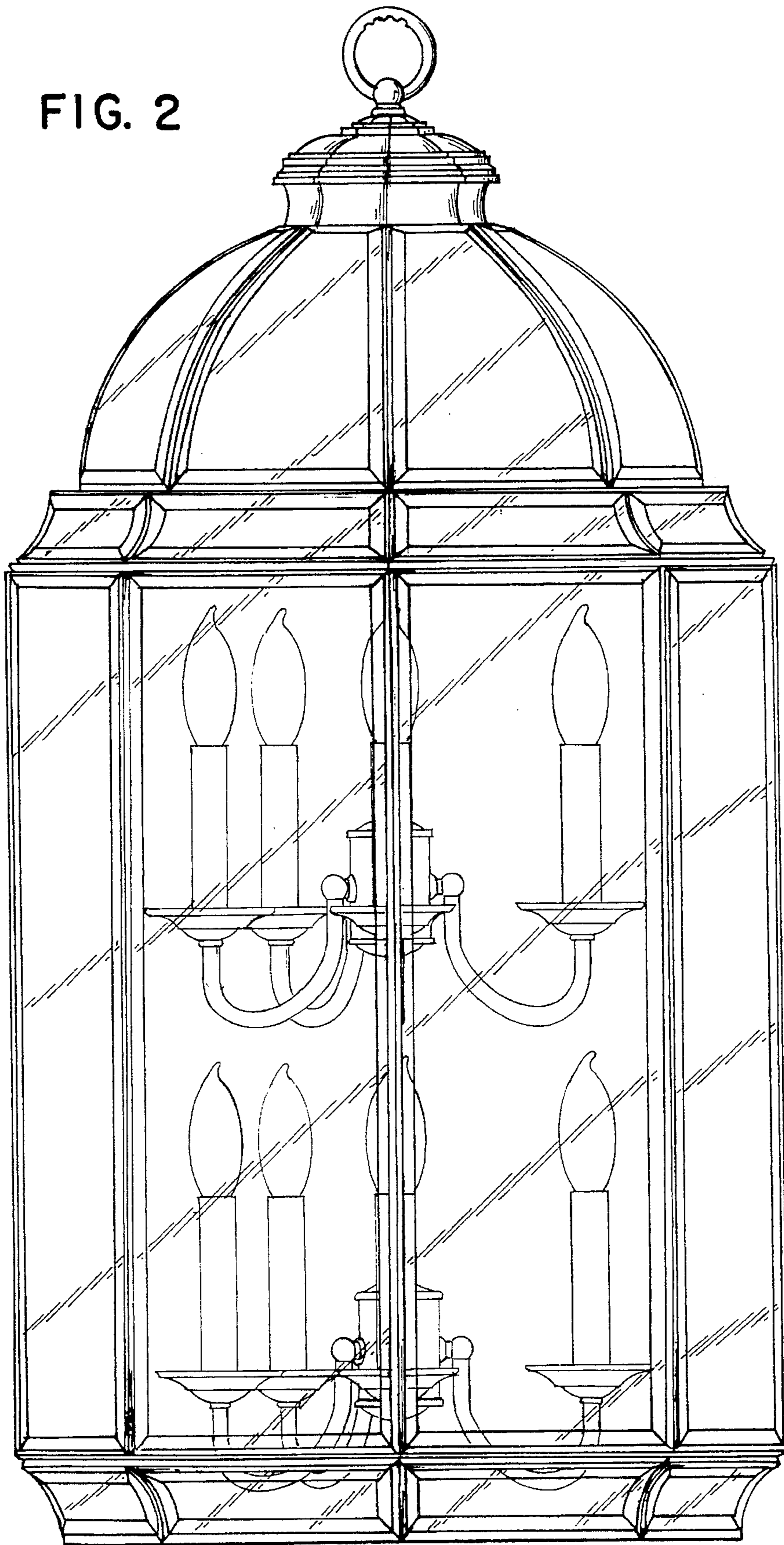

FIG. 3

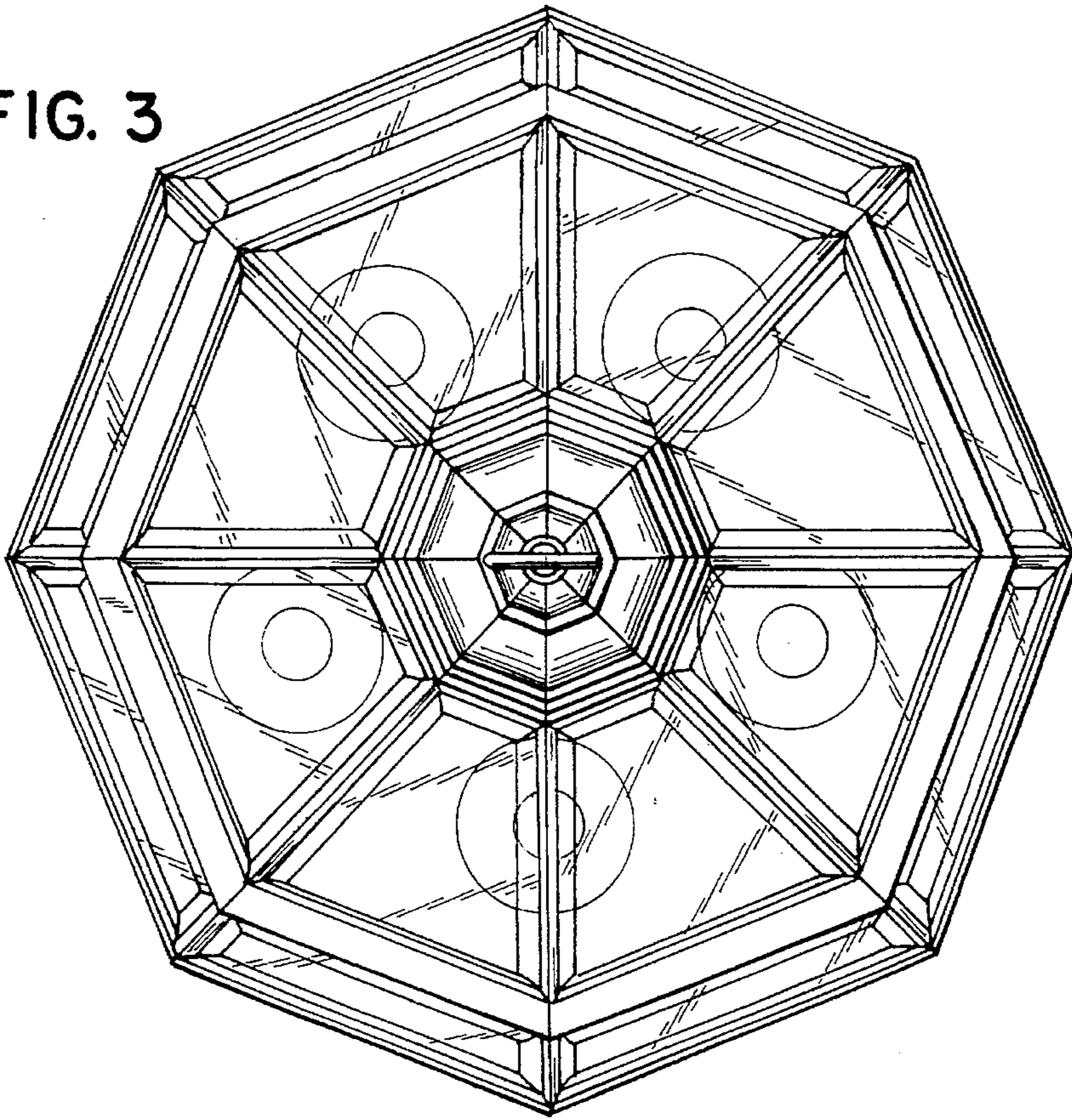

FIG. 4

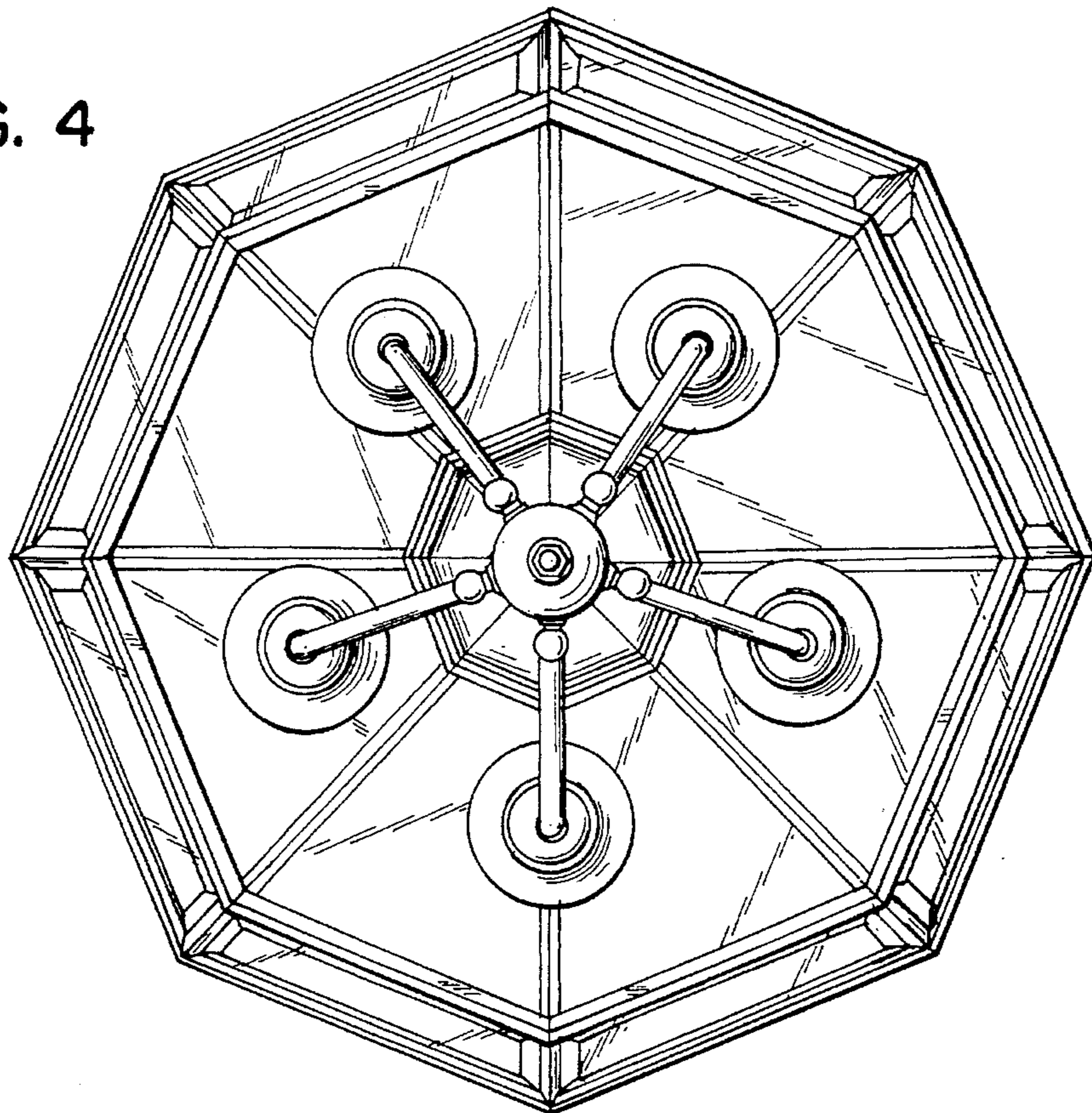

FIG. 5

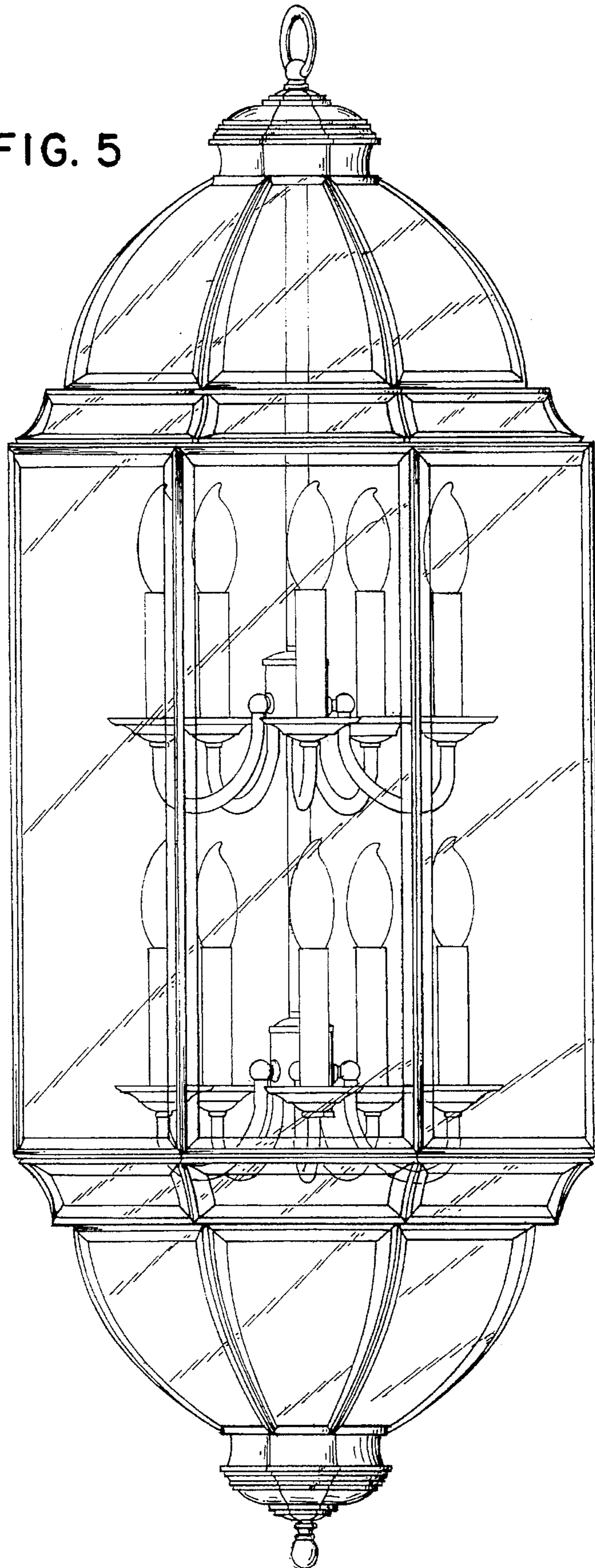

FIG. 6

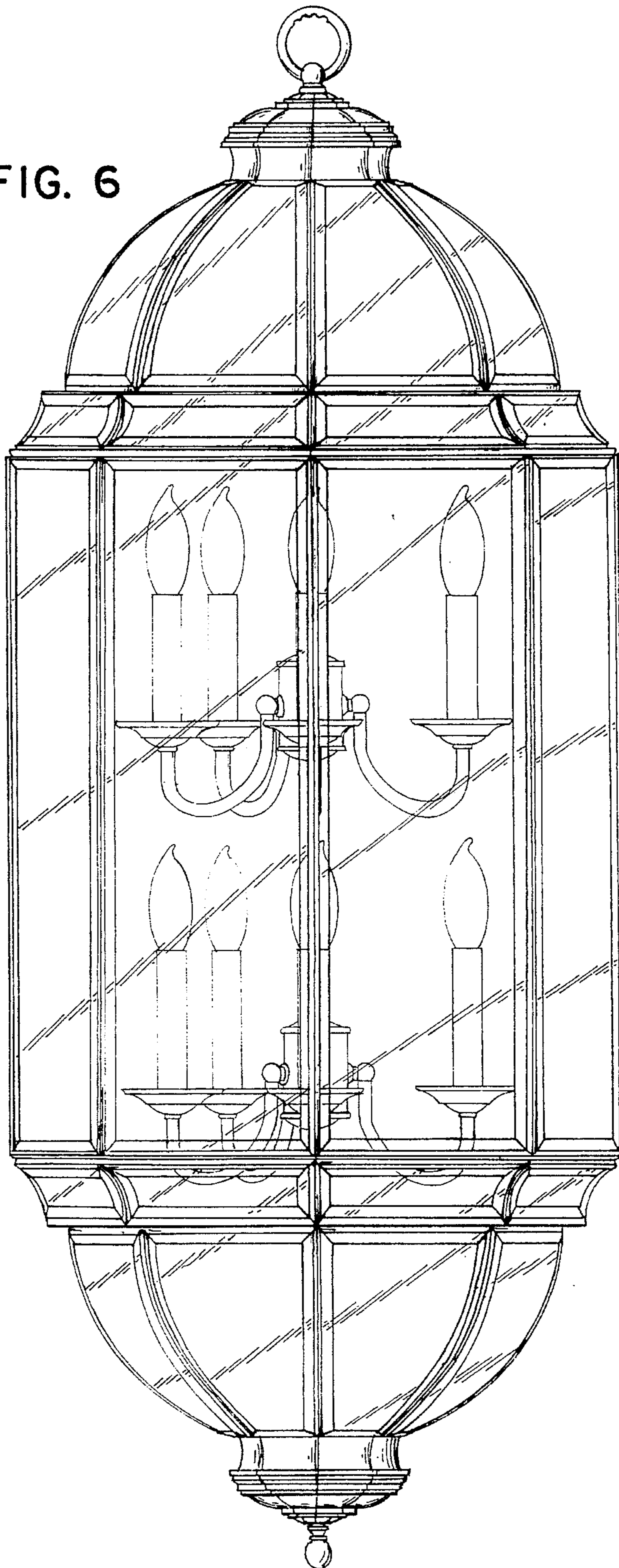

FIG. 7

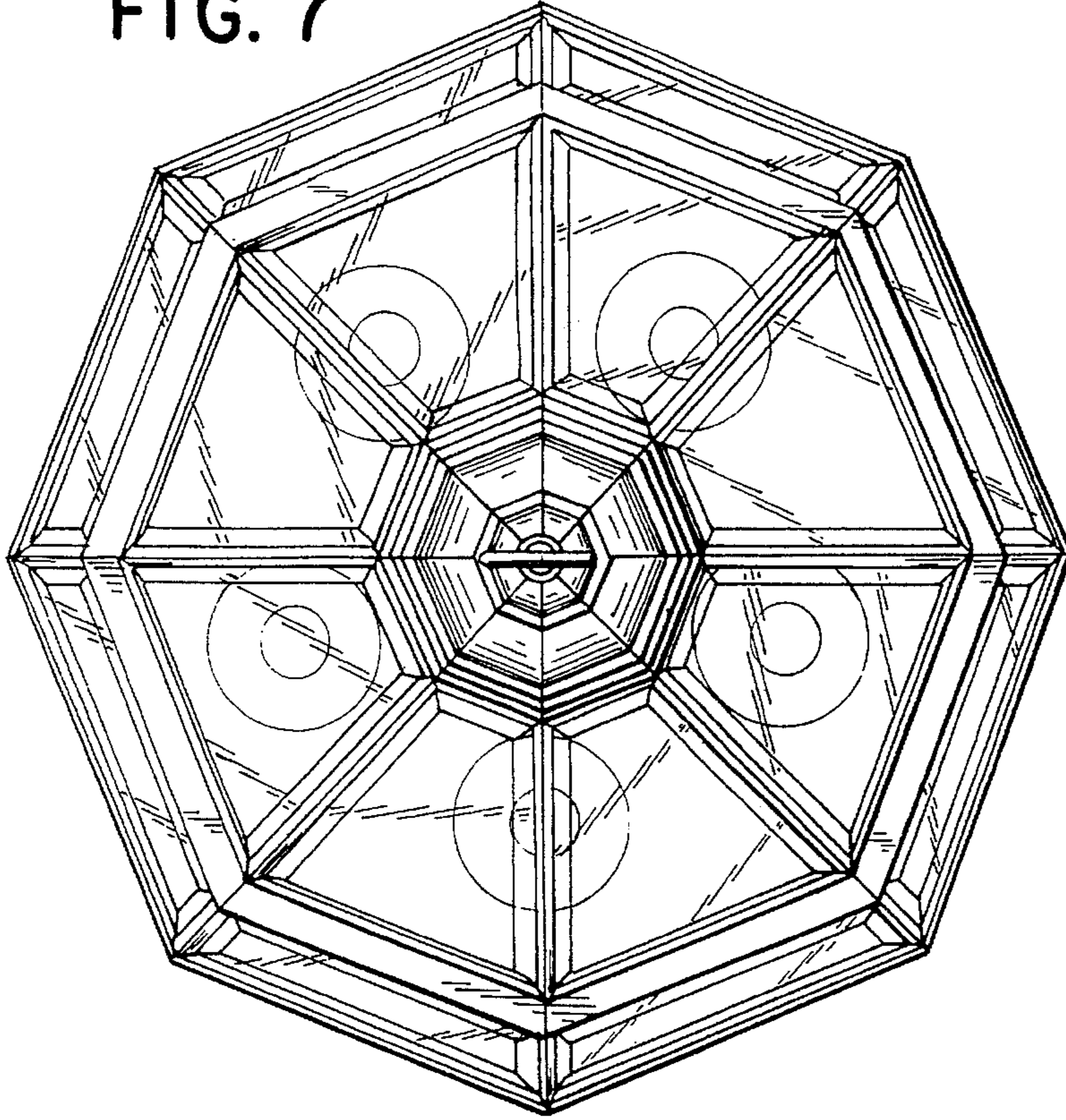

FIG. 8

