



US00D367888S

United States Patent [19]

[11] Patent Number: **Des. 367,888**

Lai

[45] Date of Patent: ****Mar. 12, 1996**

[54] **TEACHING AID PUPPET**

[76] Inventor: **Yen-ping Lai**, No. 8, Lane 211, Linsen E. Rd., 3rd Lin, Taiping Li, East Dist., Chiayi, Taiwan

[**] Term: **14 Years**

[21] Appl. No.: **37,354**

[22] Filed: **Apr. 11, 1995**

[52] U.S. Cl. **D19/59**; D19/29; D21/153

[58] Field of Search D19/26, 27, 28, D19/29, 59; D21/152, 153, 154, 159, 188; 434/317, 429, 433, 339

[56] **References Cited**

U.S. PATENT DOCUMENTS

D. 224,325	7/1972	Frost	D21/153
2,501,802	3/1950	Howell	434/260
4,372,077	2/1983	Balbuena	434/429 X
4,661,072	4/1987	White	434/260

Primary Examiner—A. Hugo Word

Assistant Examiner—Pamela Burgess
Attorney, Agent, or Firm—Morton J. Rosenberg; David I. Klein

[57] **CLAIM**

The ornamental design for a teaching aid puppet, as shown and described.

DESCRIPTION

FIG. 1 is a front view of a teaching aid puppet showing my design;

FIG. 2 is a rear view thereof;

FIG. 3 is a left side view thereof;

FIG. 4 is a right side view thereof;

FIG. 5 is a top view thereof;

FIG. 6 is a bottom view thereof;

FIG. 7 is a perspective view thereof;

FIG. 8 is a perspective view thereof with a teaching aid portion of the puppet being unfolded; and,

FIG. 9 is a perspective view thereof with the teaching aid portion being further unfolded.

1 Claim, 6 Drawing Sheets

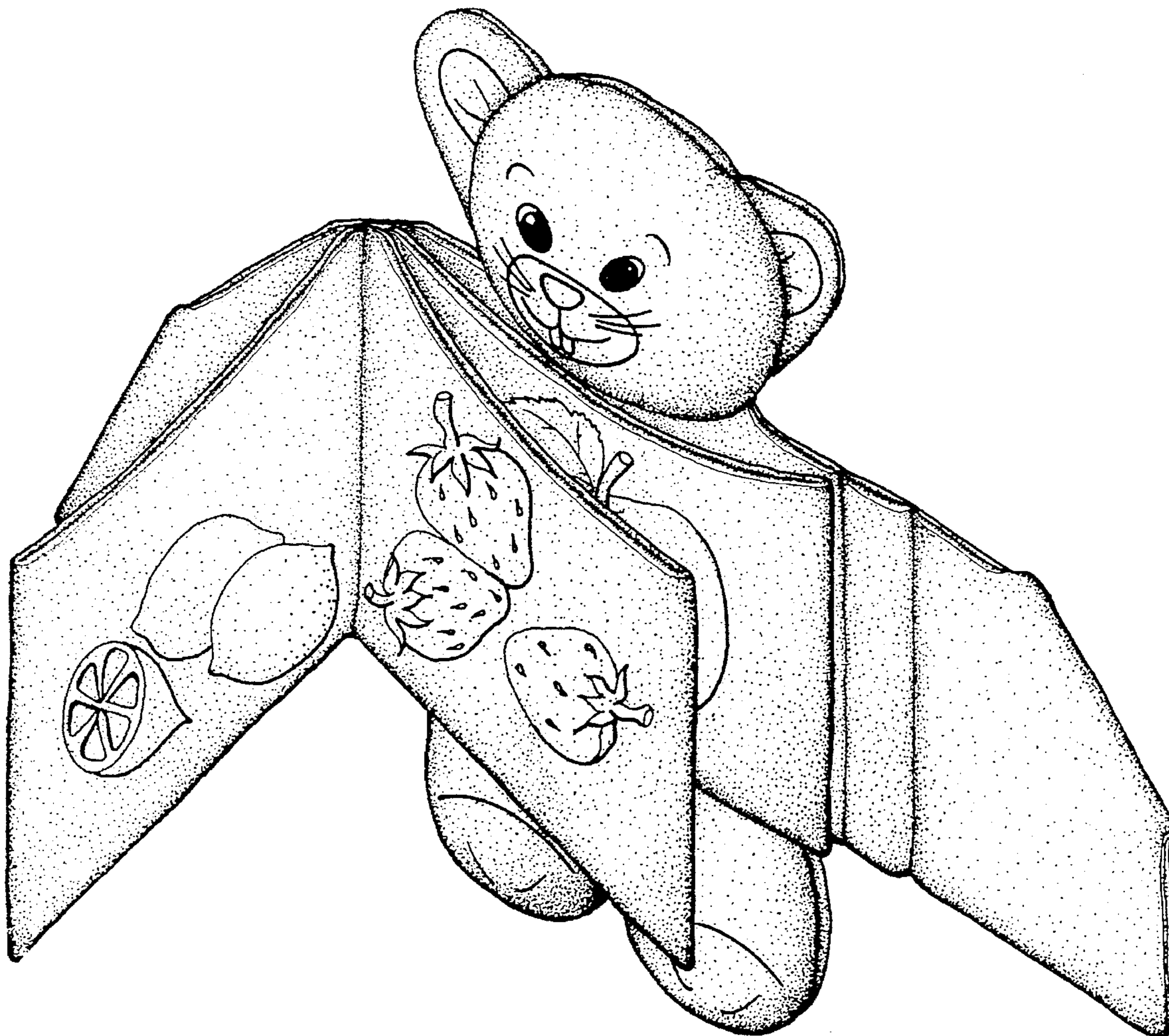

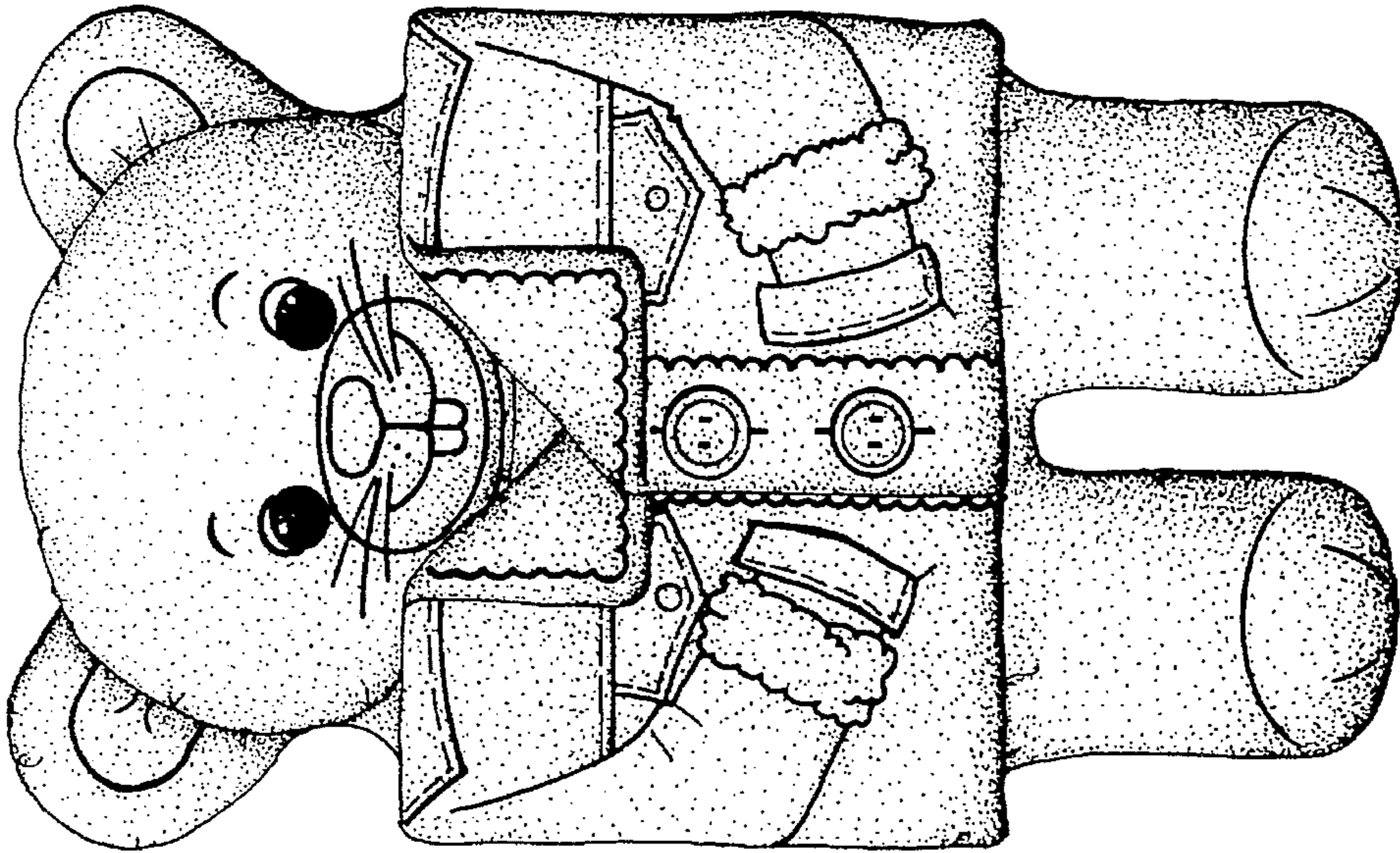

FIG.1

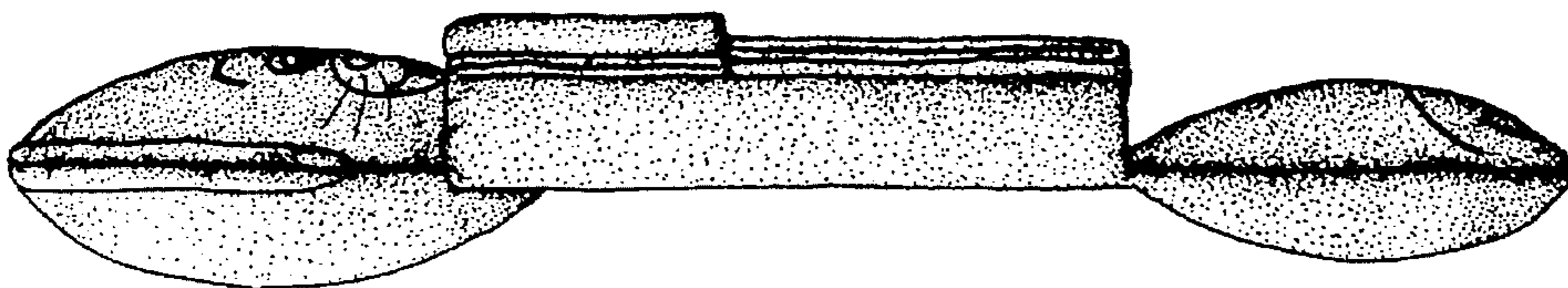

FIG.3

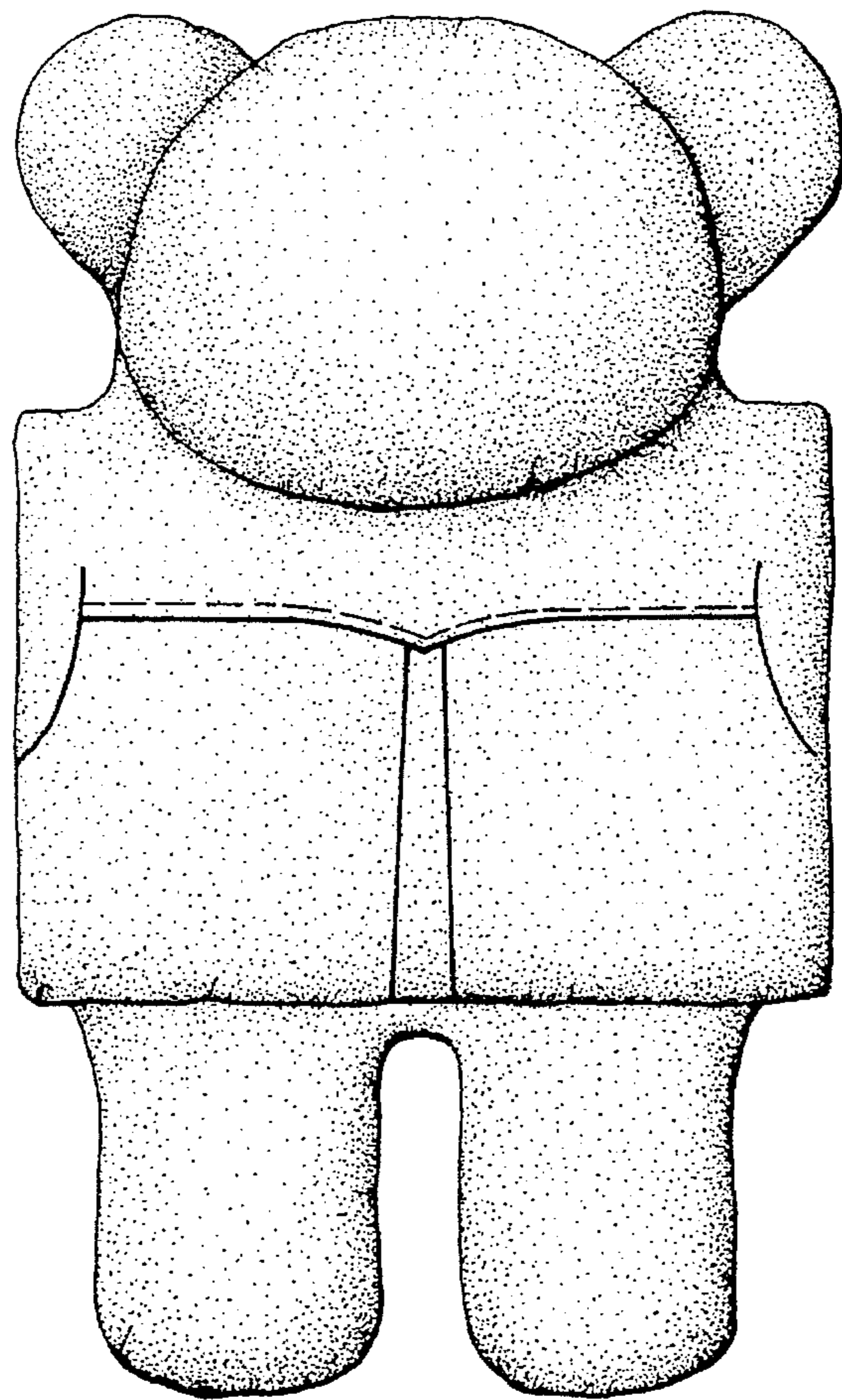

FIG. 2

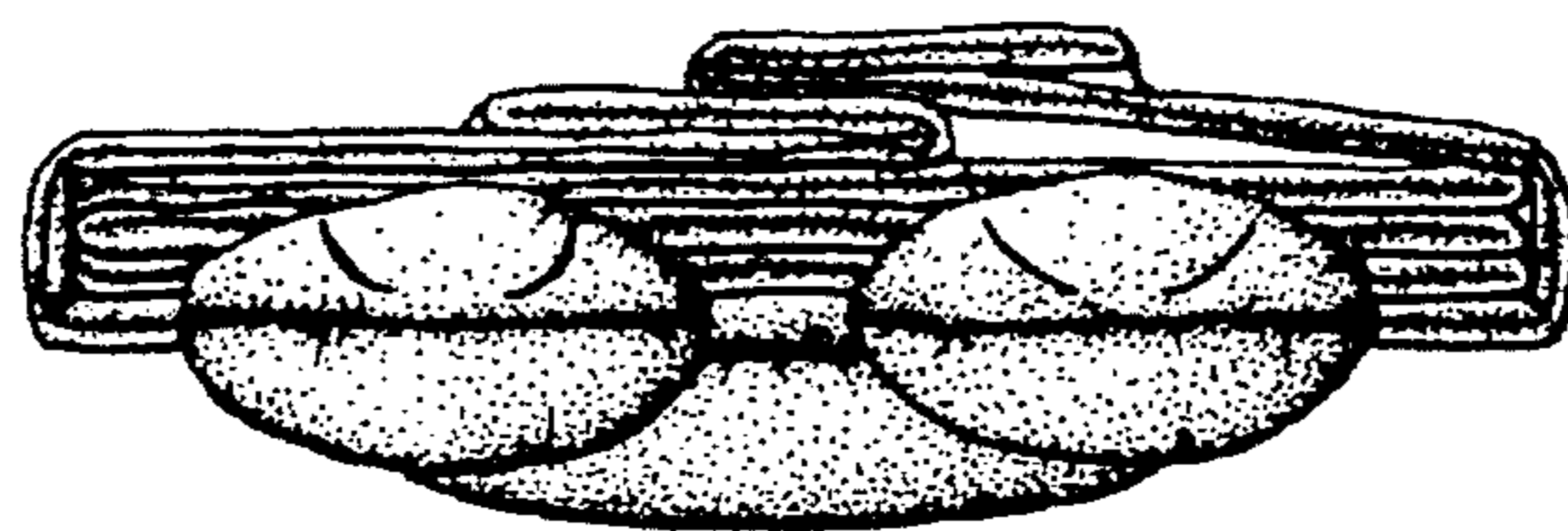

FIG. 6

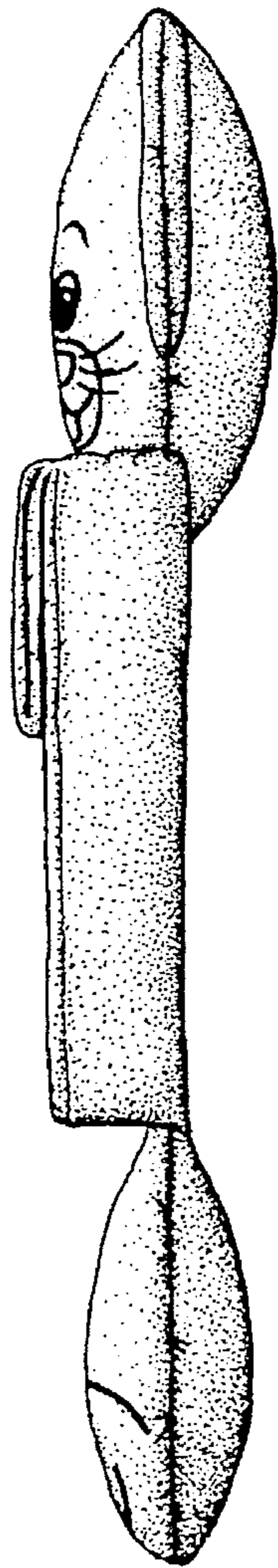

FIG. 4

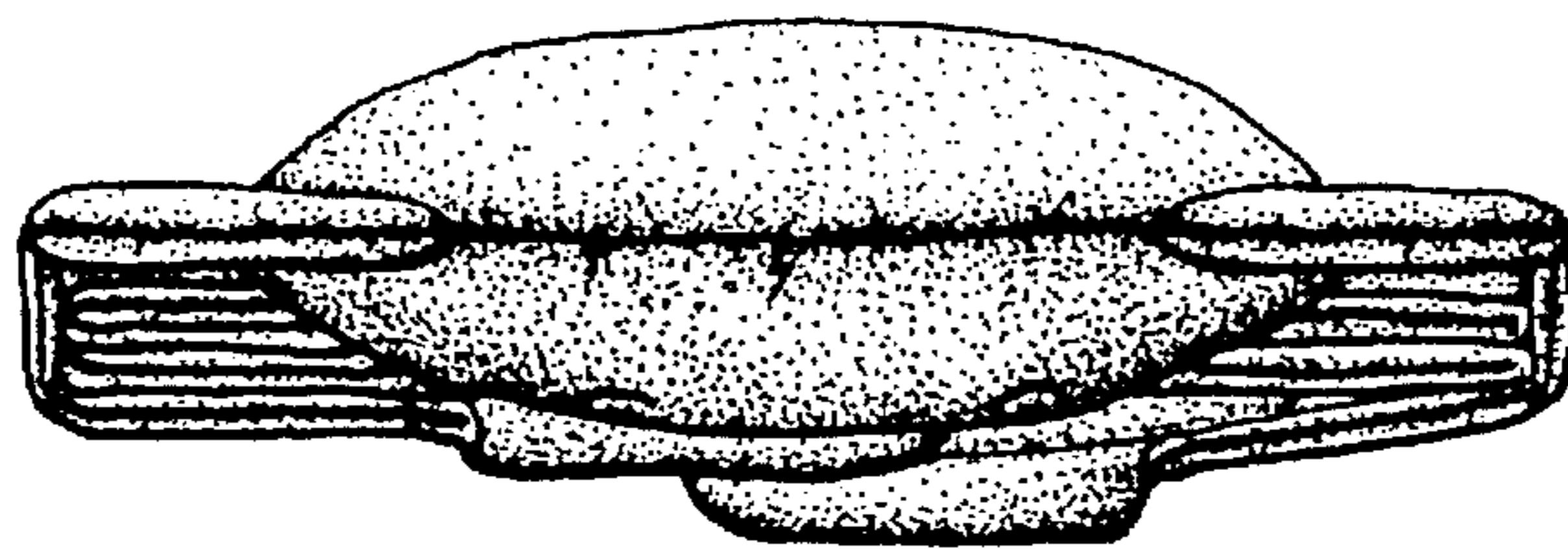

FIG. 5

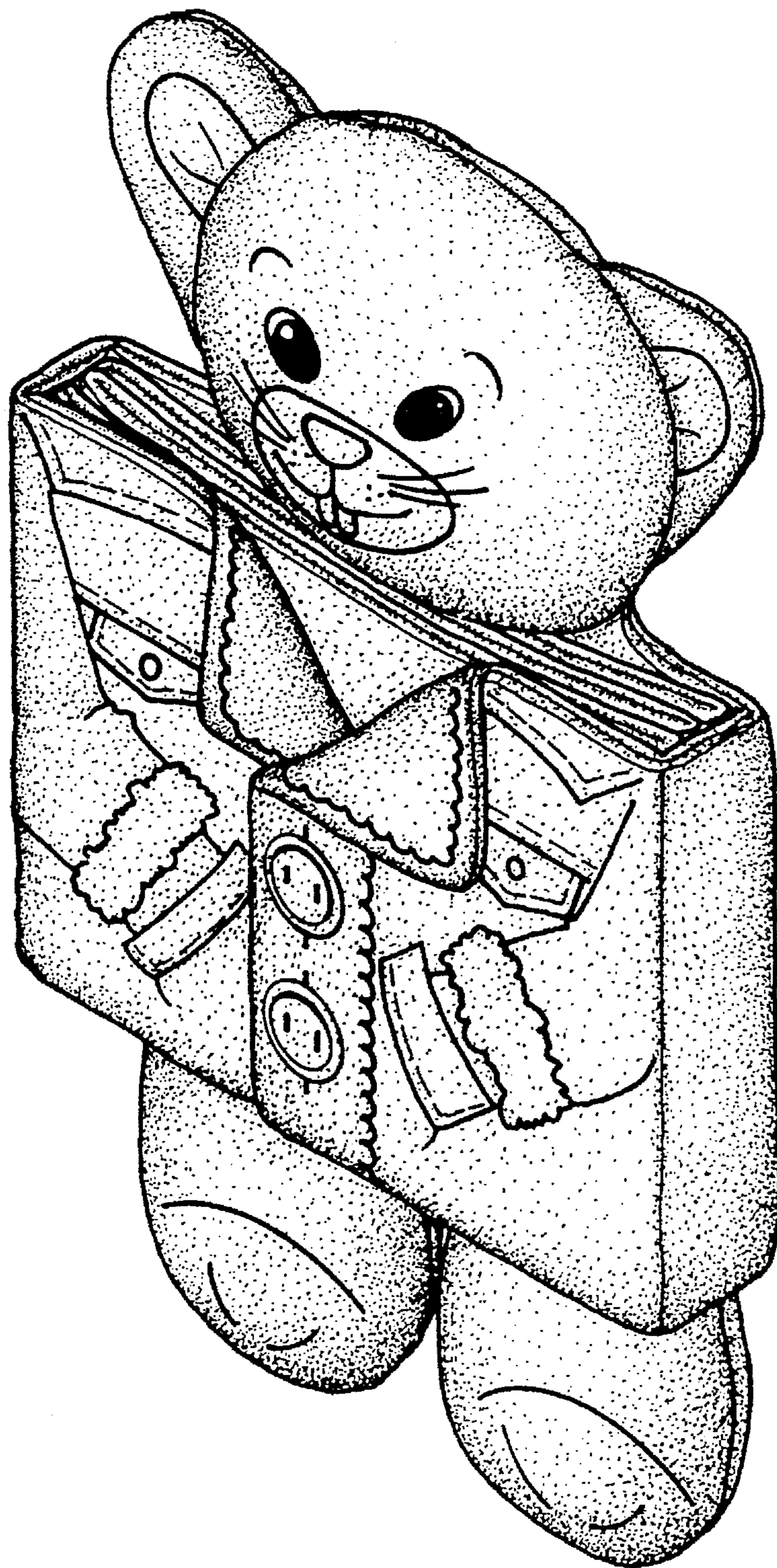

FIG. 7

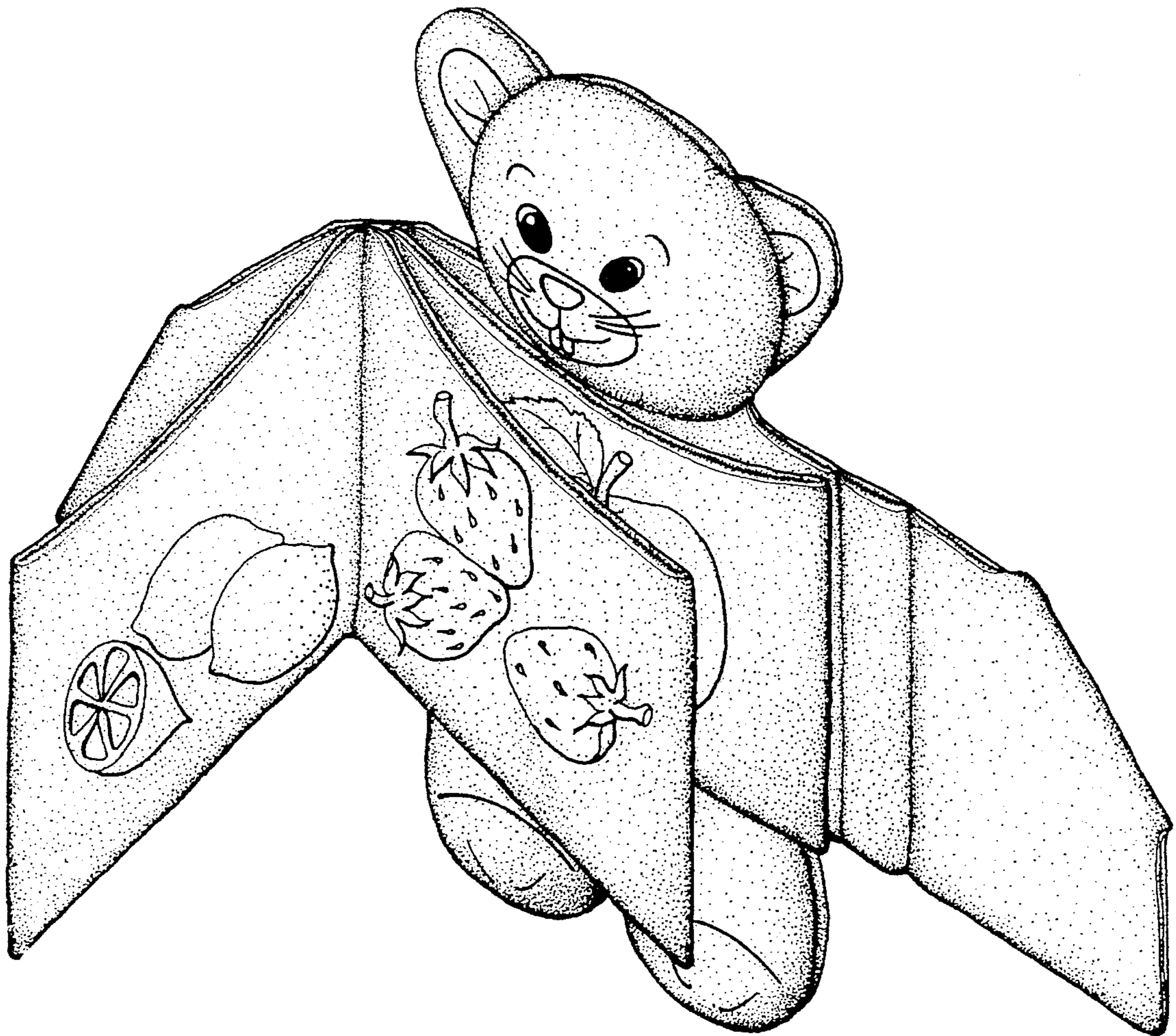

FIG. 8

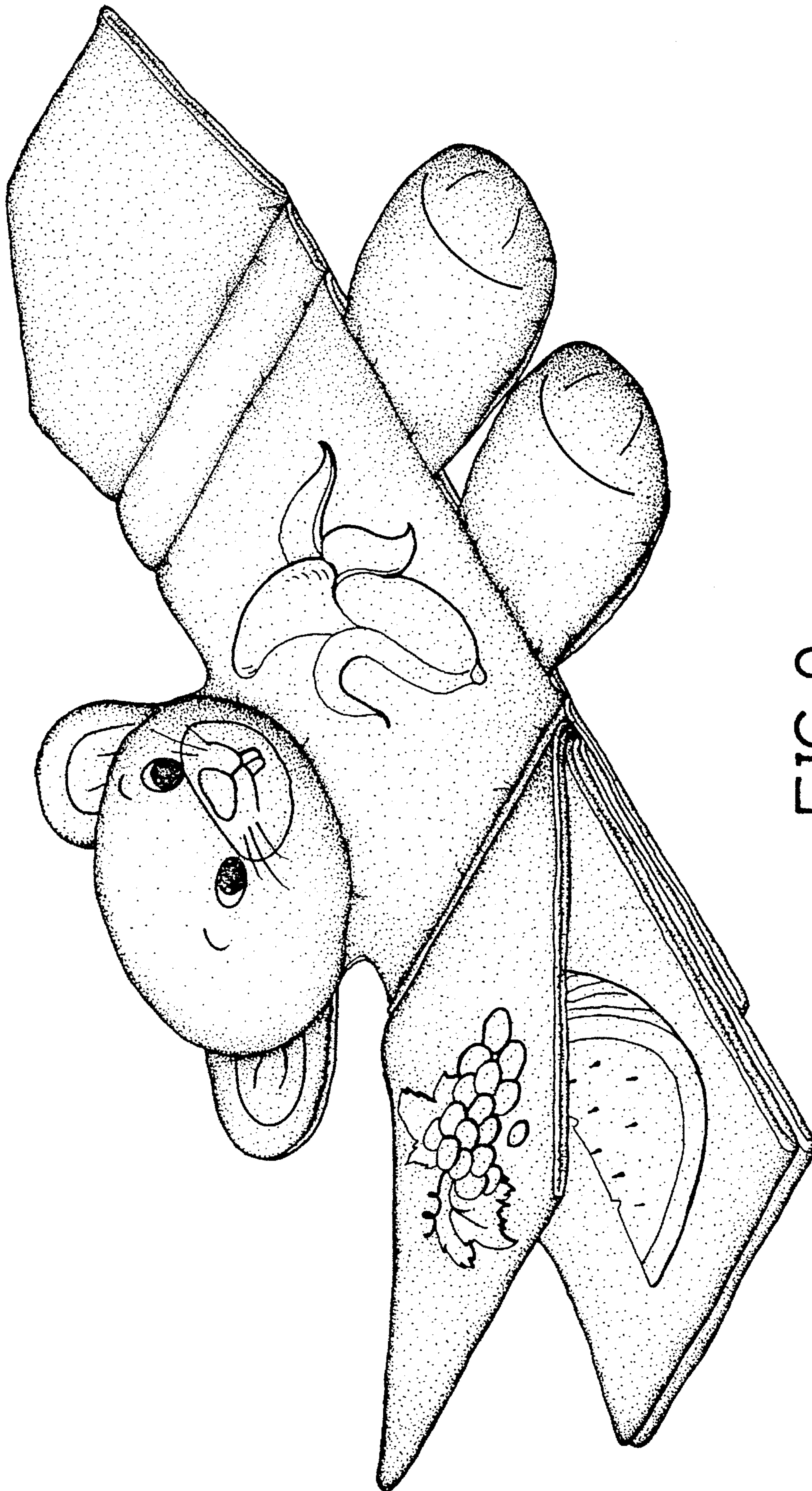

FIG. 9