



US00D367884S

# United States Patent [19]

[11] Patent Number: **Des. 367,884**

Taneya et al.

[45] Date of Patent: **\*\*Mar. 12, 1996**

[54] **INK TANK FOR PRINTER**

[75] Inventors: **Yoichi Taneya**, Yokohama; **Hiroyuki Ishinaga**, Tokyo; **Hiroyuki Tokuda**, Yokohama; **Tetsuya Sekine**, Kawasaki, all of Japan

[73] Assignee: **Canon Kabushiki Kaisha**, Tokyo, Japan

[\*\*] Term: **14 Years**

[21] Appl. No.: **32,823**

[22] Filed: **Dec. 29, 1994**

[30] **Foreign Application Priority Data**

Jul. 5, 1994 [JP] Japan ..... 6-19891

[52] U.S. Cl. .... **D18/56**; 347/86

[58] Field of Search ..... 347/86, 43; 400/207-208; D18/56

[56] **References Cited**

**U.S. PATENT DOCUMENTS**

- D. 355,928 2/1995 Tokuda et al. .... 347/86
- D. 355,930 2/1995 Tokuda et al. .... 347/86
- D. 356,110 3/1995 Tokuda et al. .... D18/56
- D. 359,755 6/1995 Tokuda et al. .... 347/86

- 4,658,273 4/1987 Yuki et al. .... 347/86
- 4,673,955 6/1987 Ameyama et al. .... 347/86
- 5,156,472 10/1992 Suzuki et al. .... 347/86
- 5,245,360 9/1993 Ebinuma et al. .... 347/86
- 5,359,353 10/1994 Hunt et al. .... 347/86
- 5,365,262 11/1994 Hattori et al. .... 347/86

**FOREIGN PATENT DOCUMENTS**

- 0107351 6/1985 Japan ..... 347/86

*Primary Examiner*—Cathy Anne MacCormac  
*Attorney, Agent, or Firm*—Fitzpatrick, Cella, Harper & Scinto

[57] **CLAIM**

The ornamental design for an ink tank for printer, as shown and described.

**DESCRIPTION**

FIG. 1 is a front elevational view of an ink tank for printer showing our new design;  
 FIG. 2 is a rear elevational view thereof;  
 FIG. 3 is a top plan view thereof;  
 FIG. 4 is a bottom plan view thereof;  
 FIG. 5 is a left side elevational view thereof;  
 FIG. 6 is a right side elevational view thereof; and,  
 FIG. 7 is a perspective view thereof;

**1 Claim, 3 Drawing Sheets**

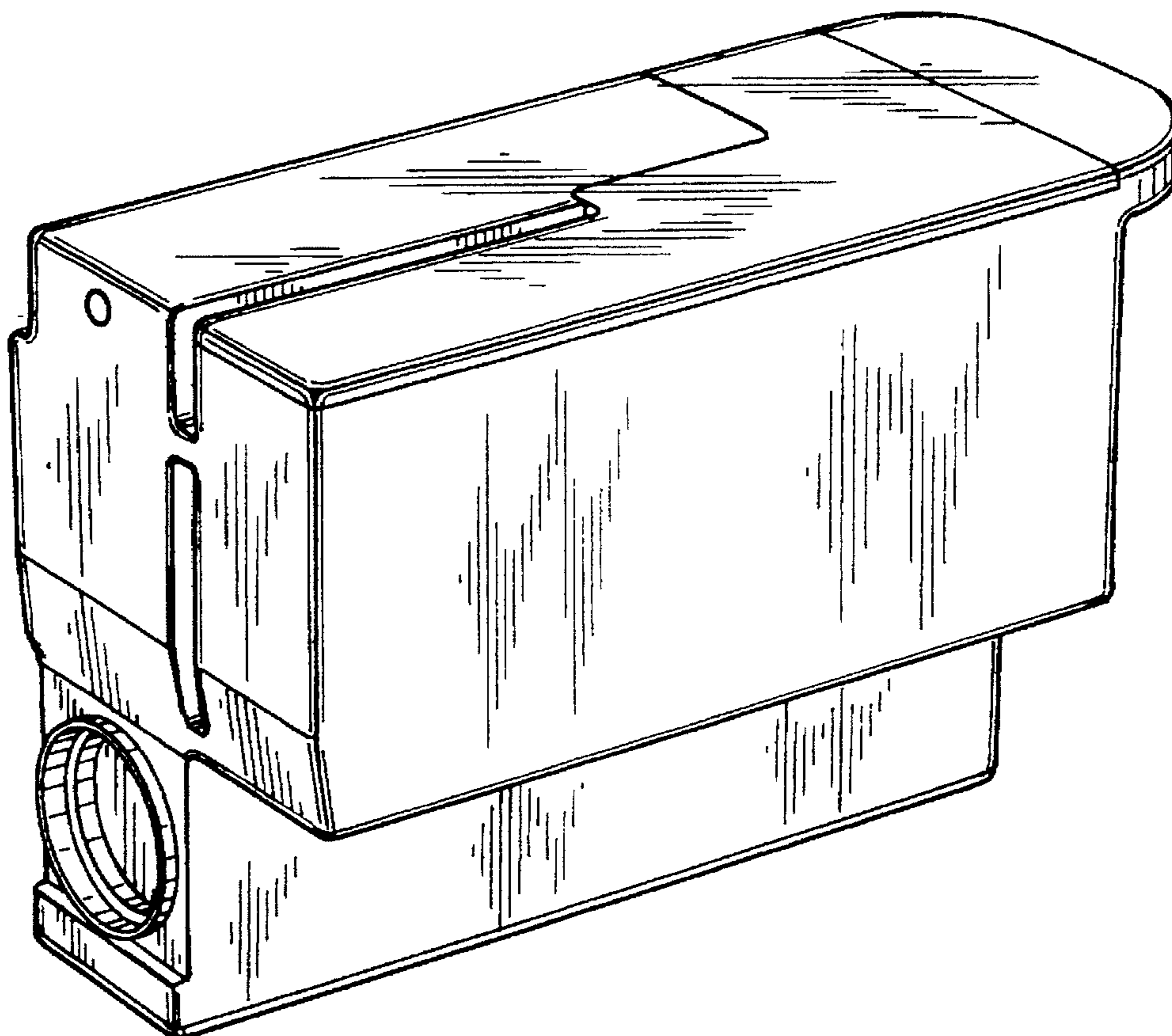

FIG. 1

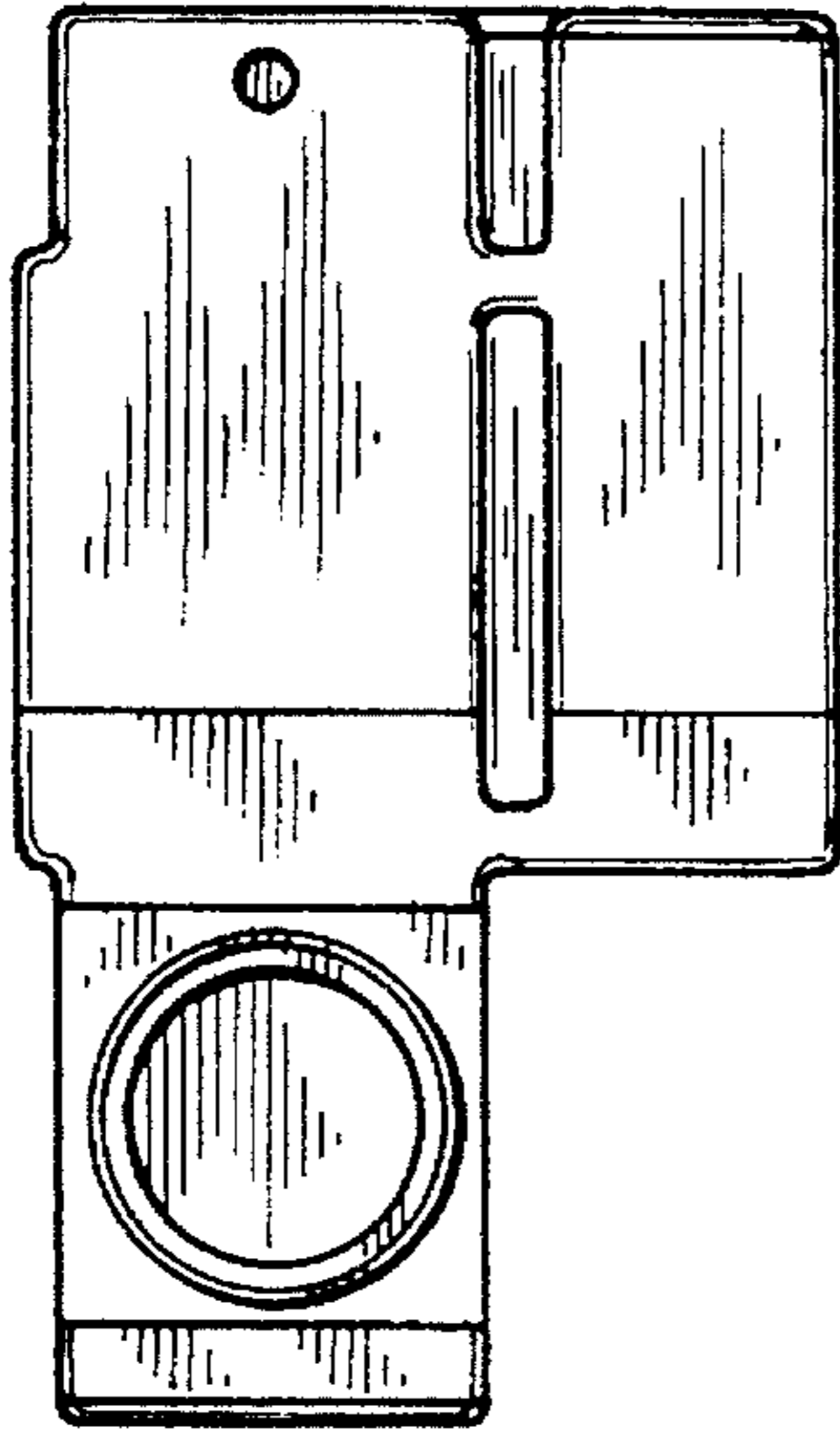

FIG. 2

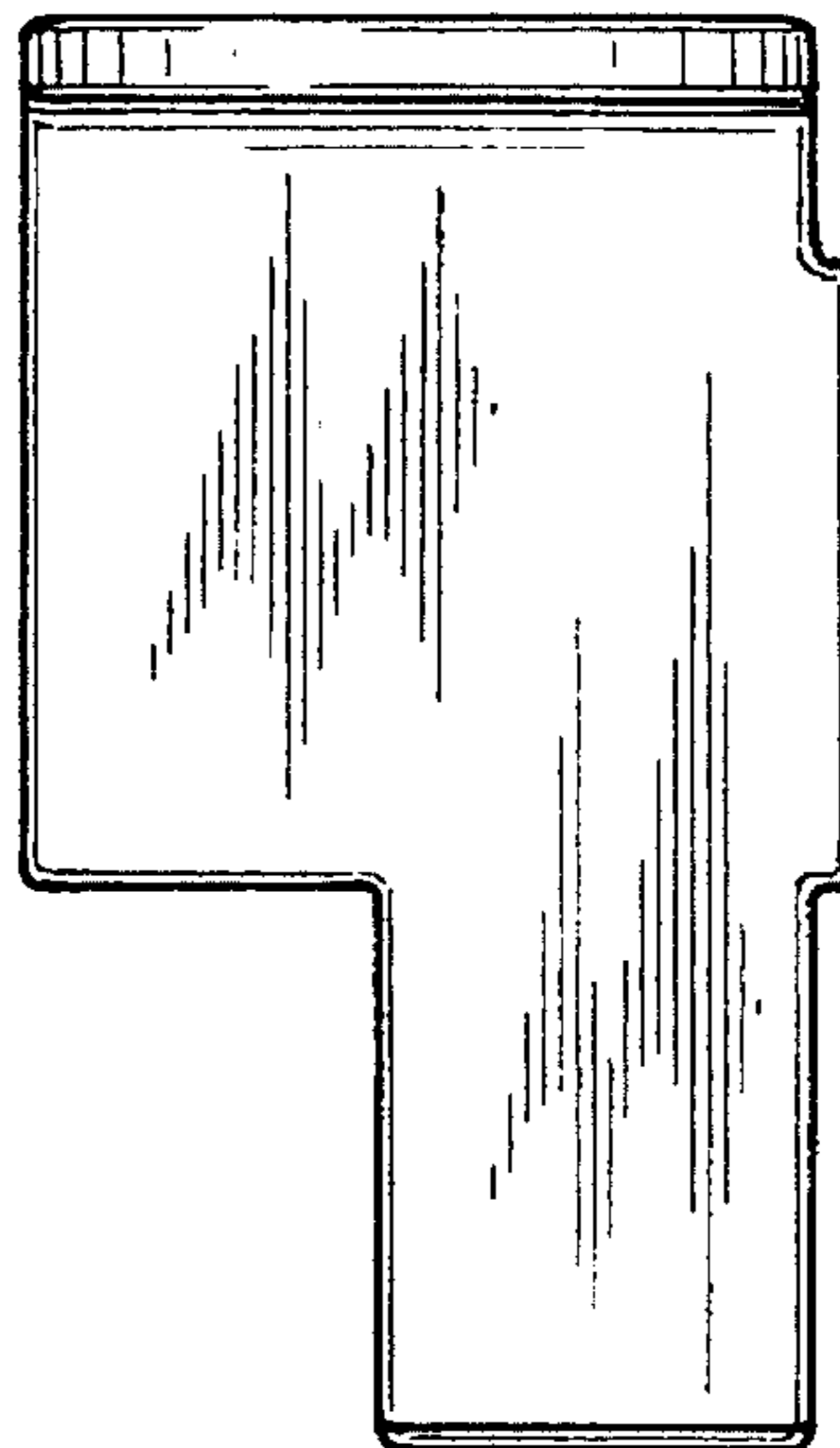

FIG. 3

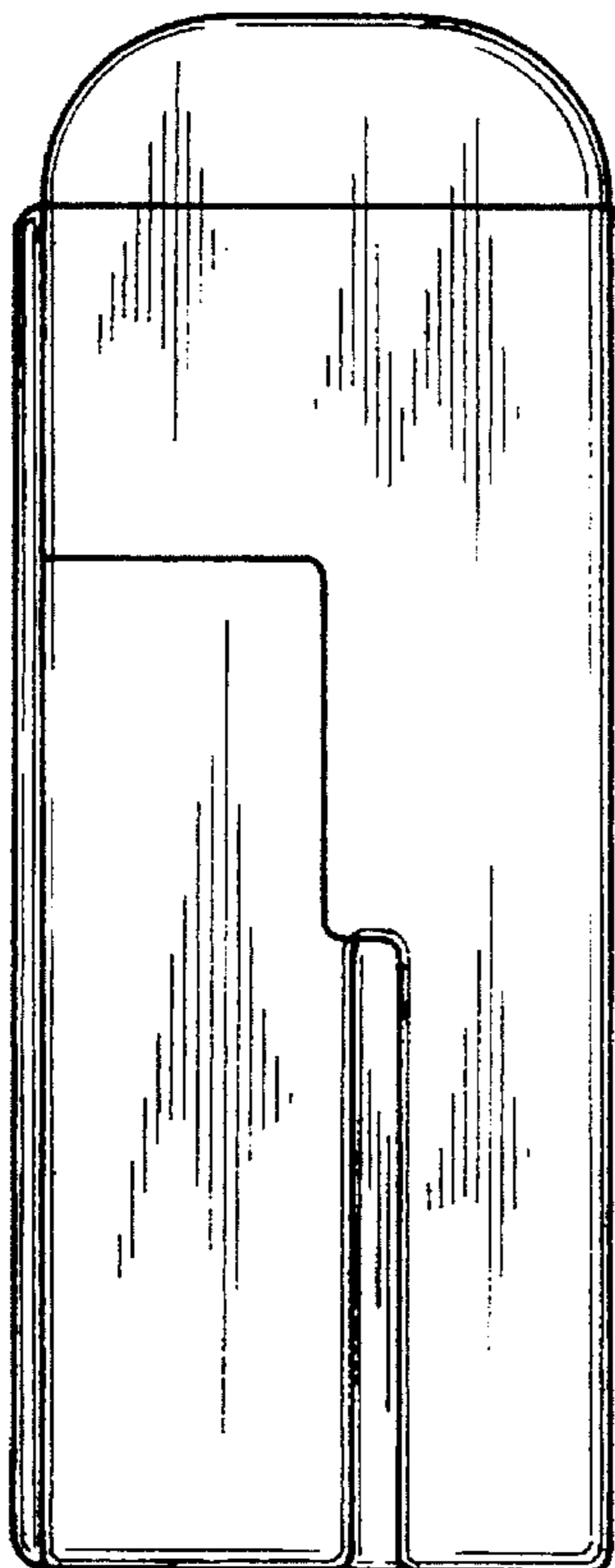
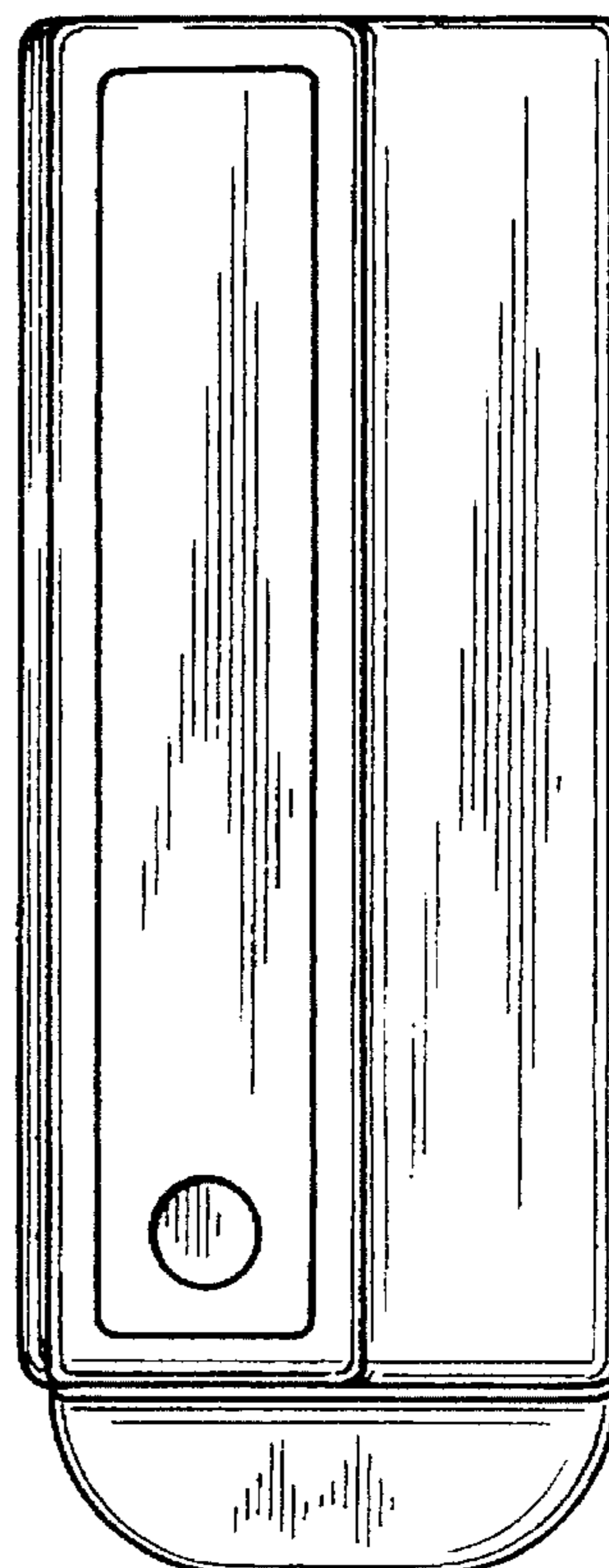
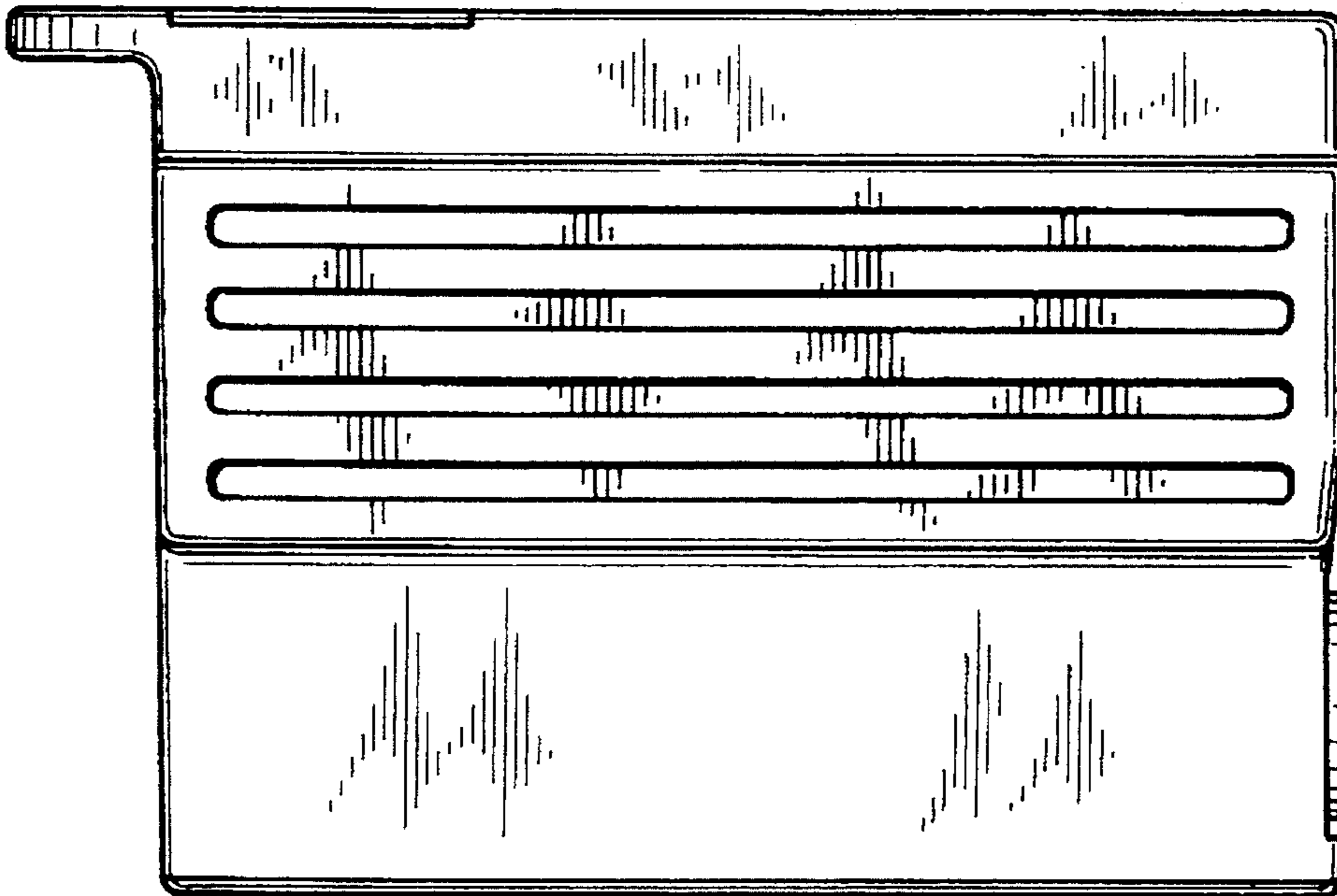

FIG. 4



*FIG. 5*



*FIG. 6*

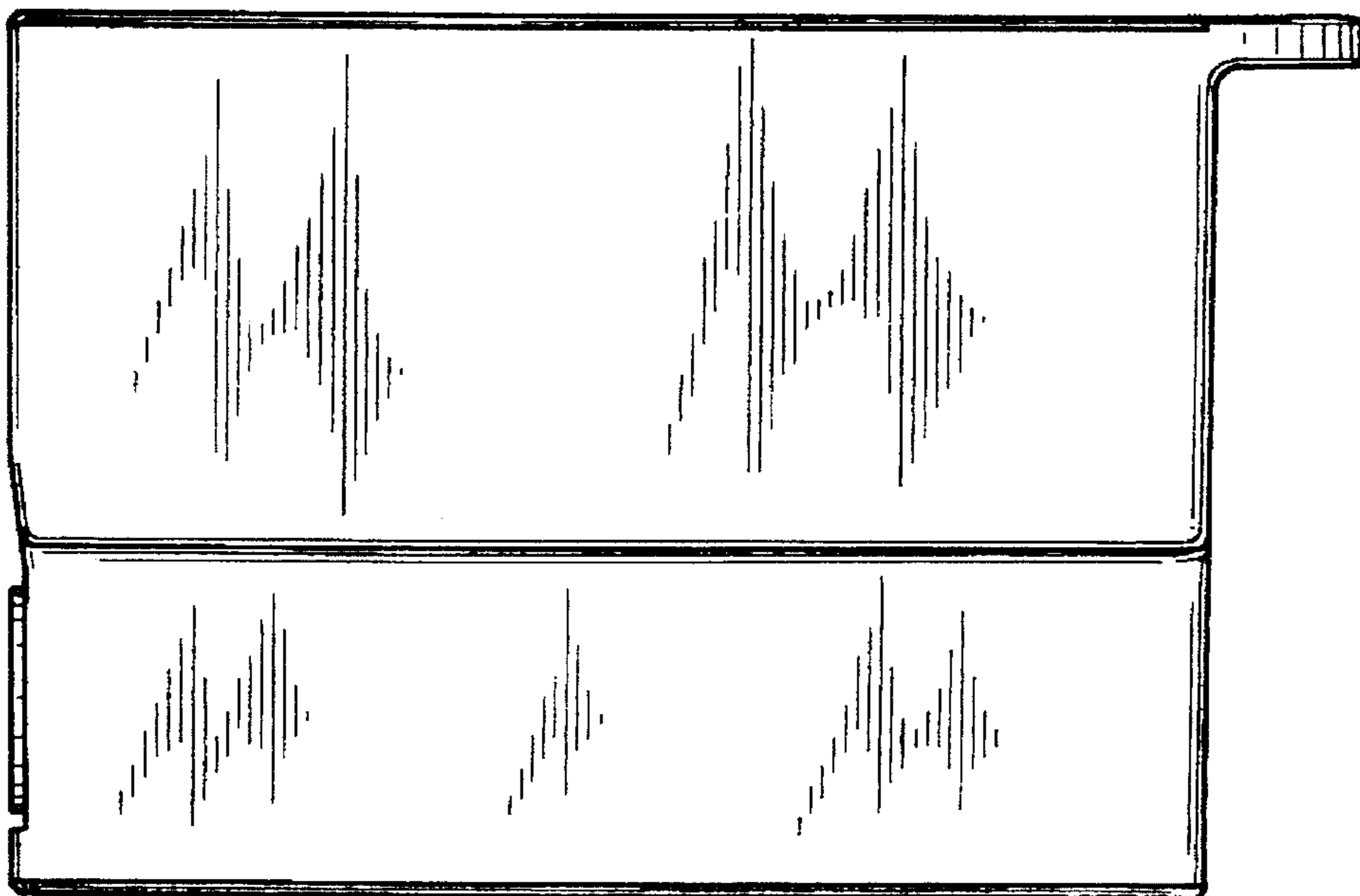

*FIG. 7*

