



US00D367880S

United States Patent [19]
Miyamoto

[11] **Patent Number: Des. 367,880**
[45] **Date of Patent: **Mar. 12, 1996**

[54] **IMAGE FORMING APPARATUS**
[75] Inventor: **Noriaki Miyamoto**, Yokohama, Japan
[73] Assignee: **Canon Kabushiki Kaisha**, Tokyo, Japan
[**] Term: **14 Years**
[21] Appl. No.: **31,235**
[22] Filed: **Nov. 15, 1994**
[30] **Foreign Application Priority Data**
May 18, 1994 [JP] Japan 6-14175
[52] **U.S. Cl.** **D18/43**
[58] **Field of Search** D18/36-46; 222/DIG. 1, 222/166, 173, 180, 325; 355/200, 245, 260

D. 350,975 9/1994 Mizuta D18/40 X
4,523,834 6/1985 Pelda et al. 222/DIG. 1
Primary Examiner—Alan P. Douglas
Assistant Examiner—S. Snapp
Attorney, Agent, or Firm—Fitzpatrick, Cella, Harper & Scinto

[57] **CLAIM**

The ornamental design for an image forming apparatus, as shown and described.

DESCRIPTION

FIG. 1 is a front elevational view of an image forming apparatus showing my new design; FIG. 2 is a rear elevational view thereof; FIG. 3 is a top plan view thereof; FIG. 4 is a bottom plan view thereof; FIG. 5 is a left side elevational view thereof; FIG. 6 is a right side elevational view thereof; and, FIG. 7 is a perspective view thereof.

[56] **References Cited**
U.S. PATENT DOCUMENTS
D. 332,962 2/1993 Kiluchi et al. D18/40 X

1 Claim, 3 Drawing Sheets

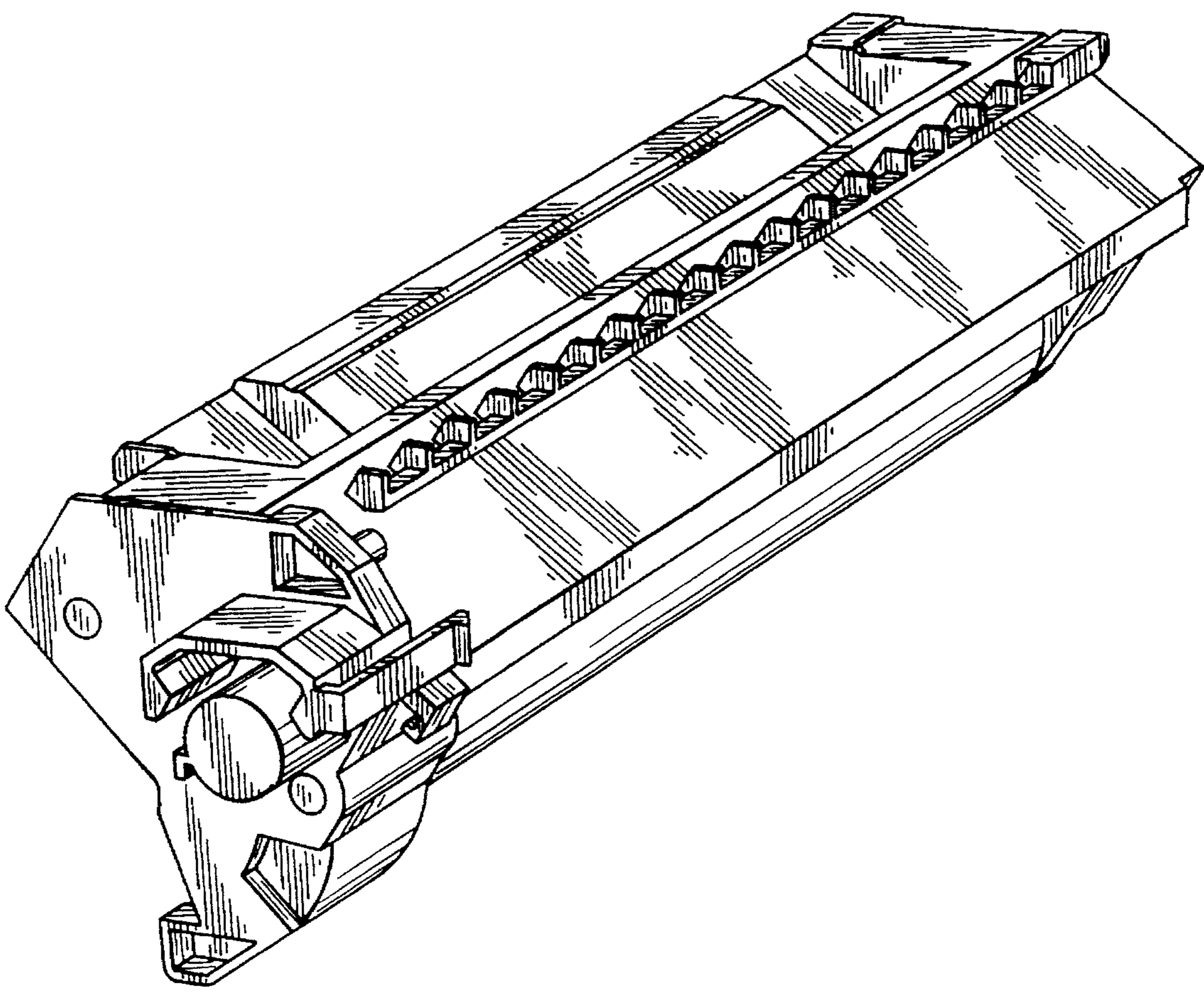

FIG. 1

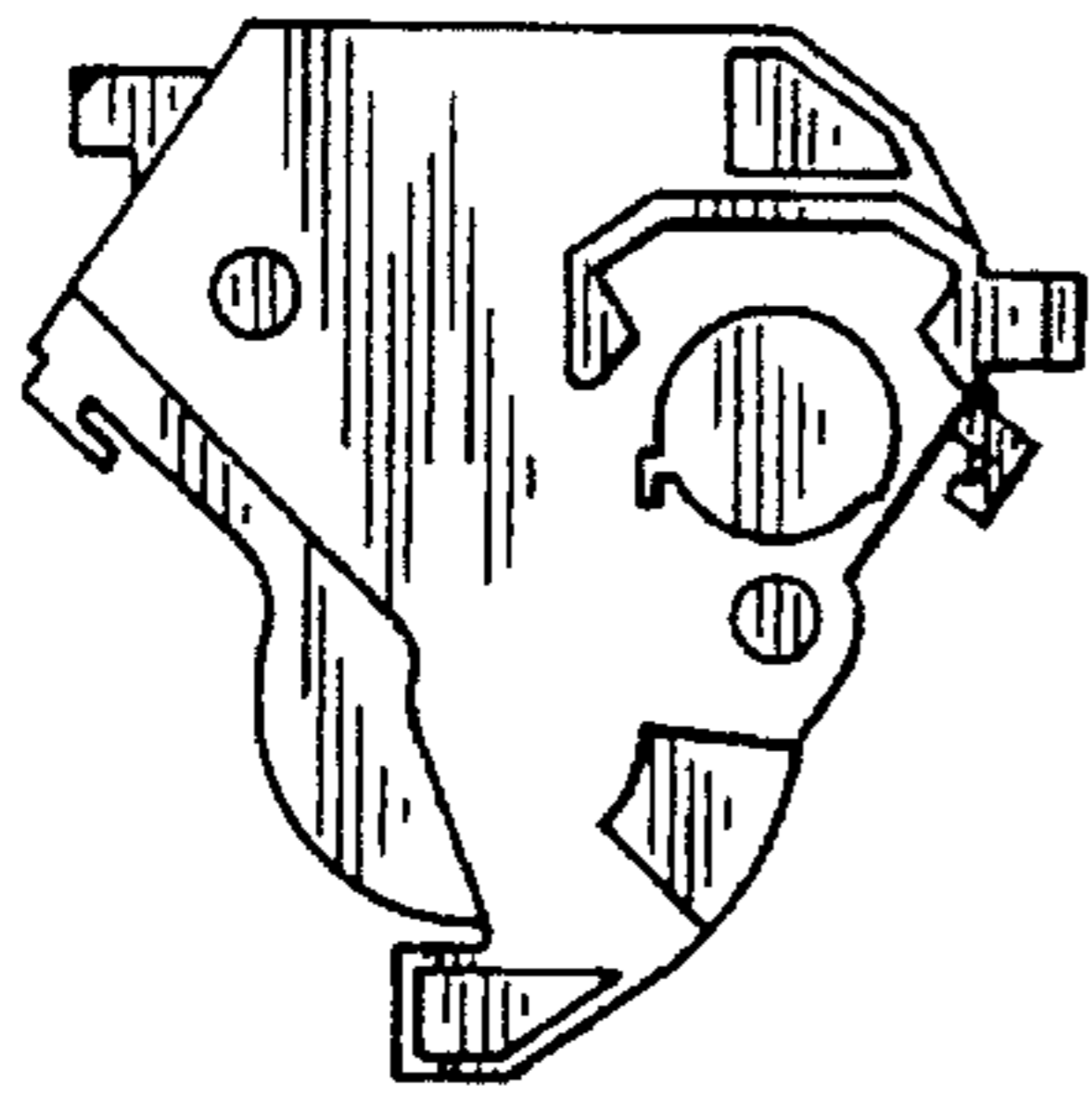

FIG. 2

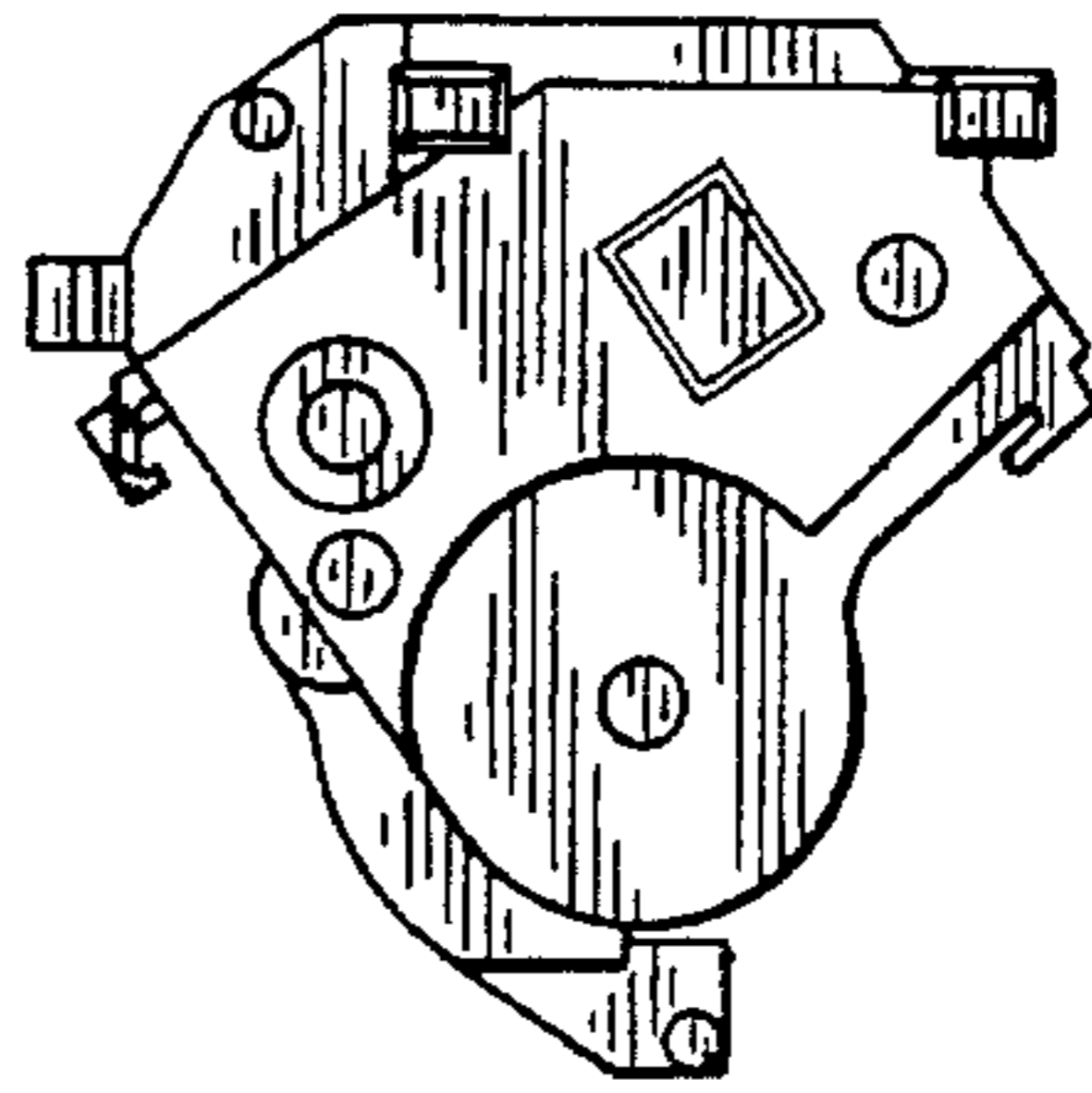

FIG. 3

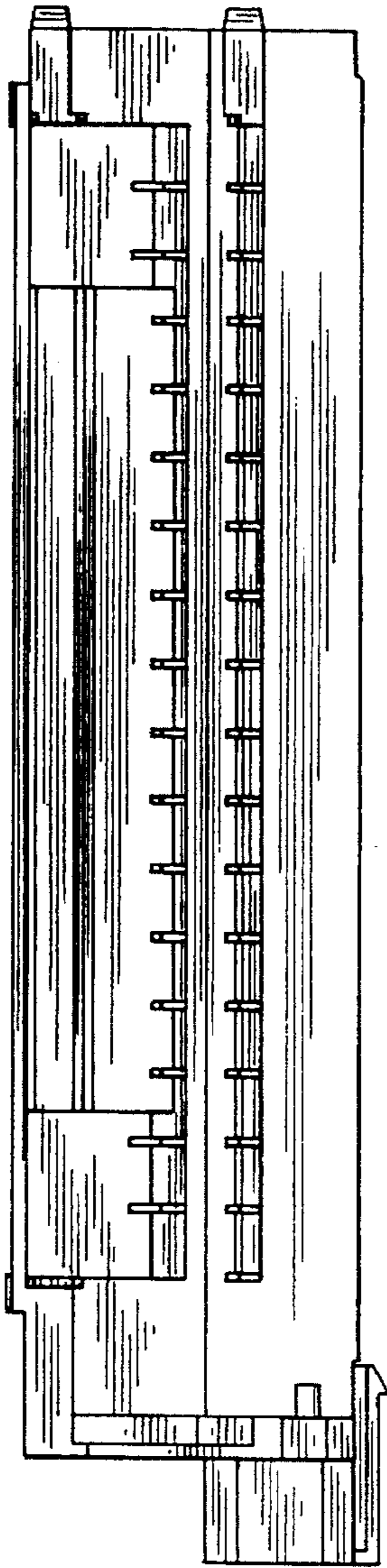

FIG. 4

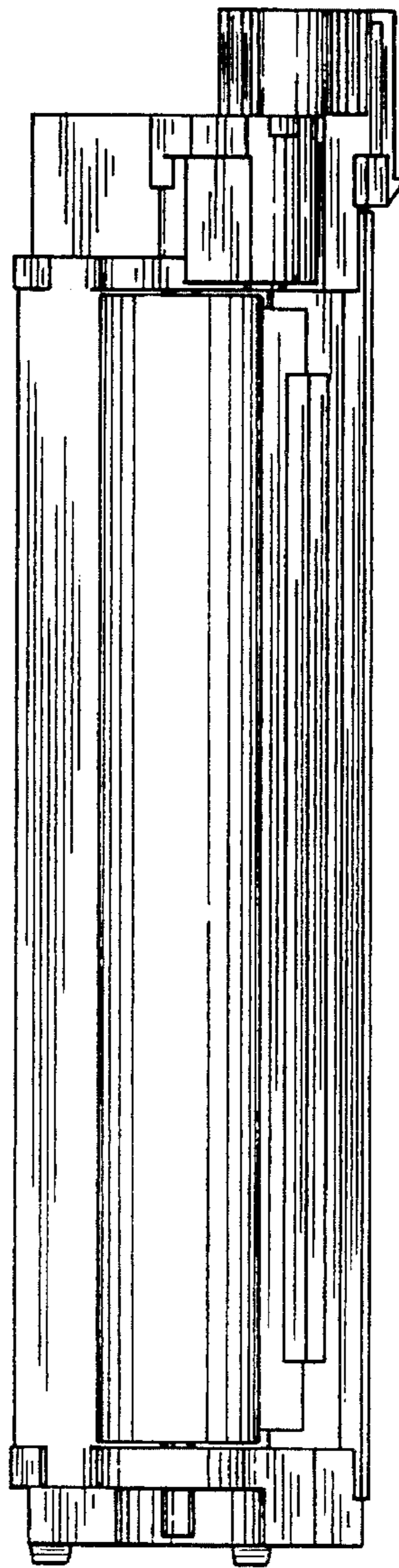

FIG. 5

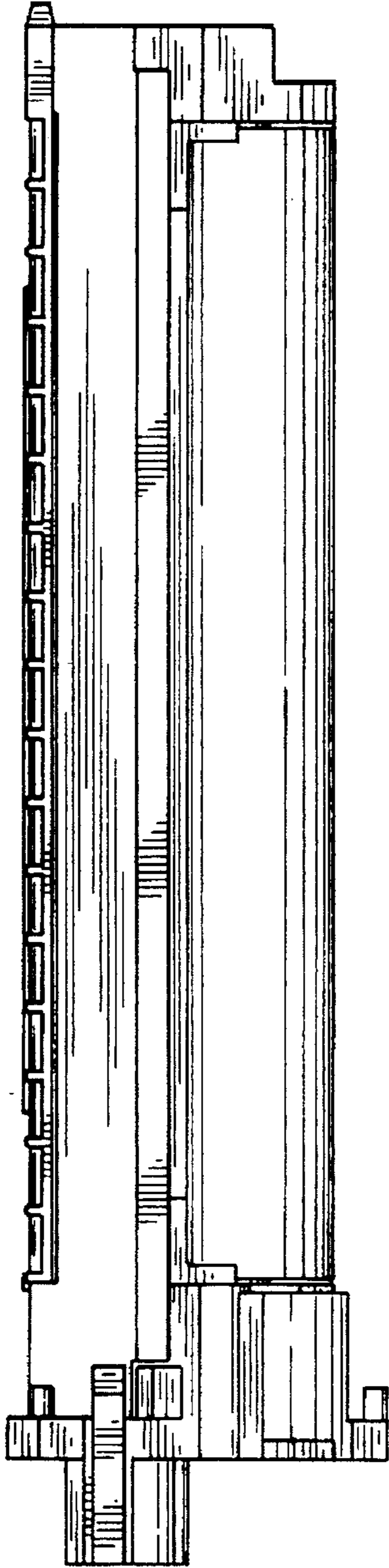

FIG. 6

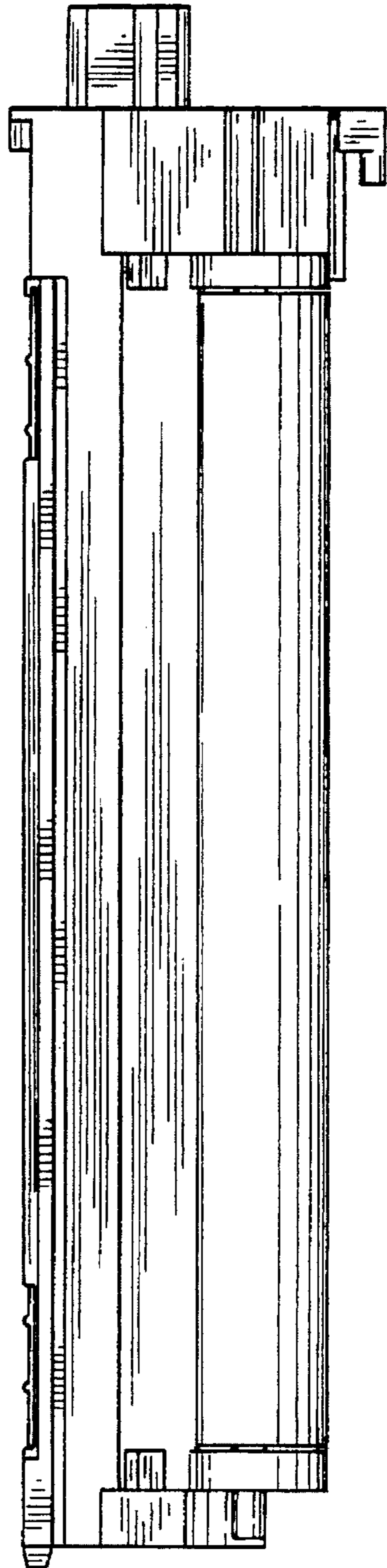

FIG. 7

