



US00D367803S

# United States Patent [19] Hardway

[11] **Patent Number:** **Des. 367,803**  
[45] **Date of Patent:** **\*\*Mar. 12, 1996**

[54] **CUP HOLDER**

[76] **Inventor:** **Wayne Hardway**, 6370 Simms St.,  
Hollywood, Fla. 33024

[\*\*] **Term:** **14 Years**

[21] **Appl. No.:** **23,803**

[22] **Filed:** **Jun. 1, 1994**

[52] **U.S. Cl.** ..... **D7/620**

[58] **Field of Search** ..... D7/619-624; D9/455;  
224/42.45 R, 42.46 R; 248/311.2, 313,  
215, 145.6; 211/71, 74; D12/419, 420

[56] **References Cited**

**U.S. PATENT DOCUMENTS**

D. 256,279	8/1980	Huggins	.....	D7/620	X
D. 340,622	10/1993	Park et al.	.....	D7/620	
1,147,856	7/1915	Gilcheist	.....	248/145.6	
2,673,057	3/1954	Morris, Sr.	.....	248/311.2	
3,491,976	1/1970	Larson	.....	D7/620	X
4,727,890	3/1988	Vincent	.....	248/311.2	X

*Primary Examiner*—Terry A. Wallace

*Attorney, Agent, or Firm*—Herbert L. Lerner; Laurence A. Greenberg

[57] **CLAIM**

The ornamental design for the cup holder, as shown and described.

**DESCRIPTION**

FIG. 1 is a side-elevational view of the cup holder showing my new design; the opposite side being a mirror image; FIG. 2 is a front-elevational view thereof; FIG. 3 is a rear-elevational view thereof; FIG. 4 is a bottom-plan view thereof; FIG. 5 is a top-plan view thereof, the beverage mug is shown in broken lines for illustrative purposes only and forms no part of the claimed design; FIG. 6 is a partial top-plan view of a readily adjustable extender clamp with a wing nut, the rest of the cup holder being identical to FIGS. 1-5; and, FIG. 7 is a side-elevational view of the partial view of the embodiment of FIG. 6.

**1 Claim, 3 Drawing Sheets**

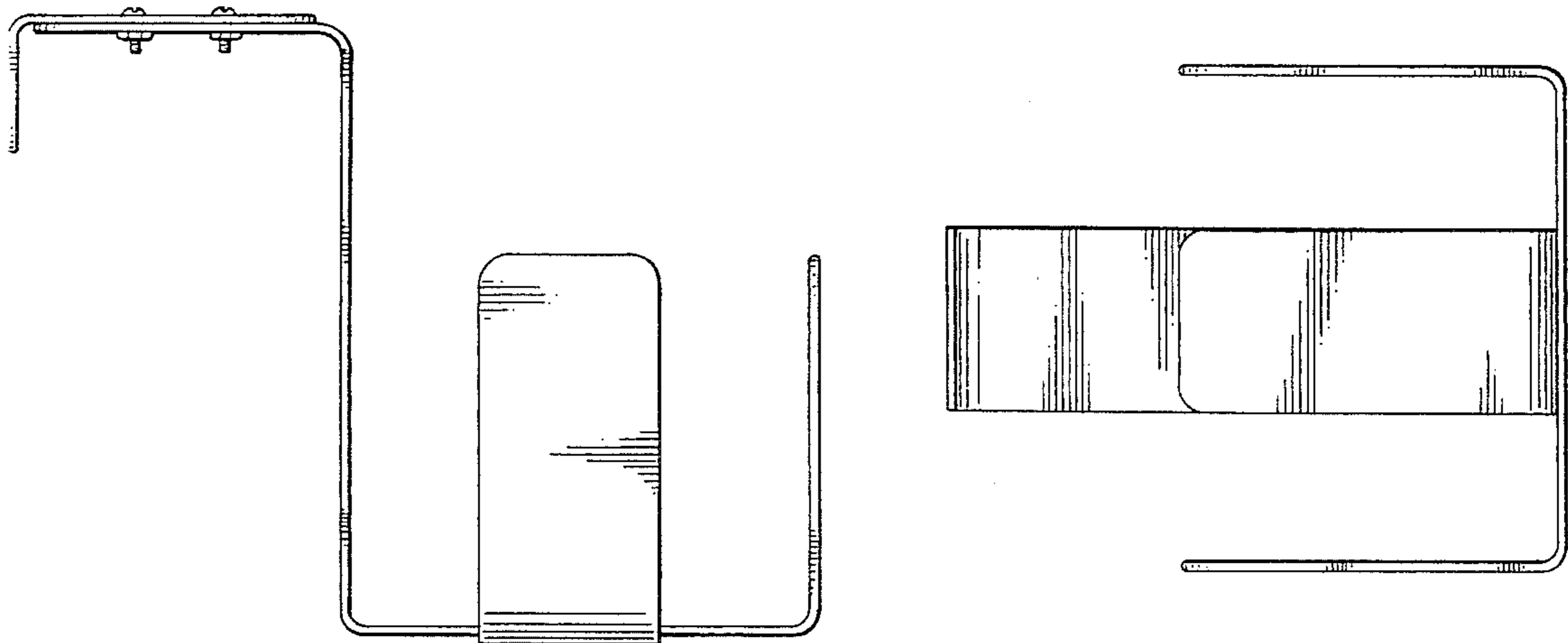

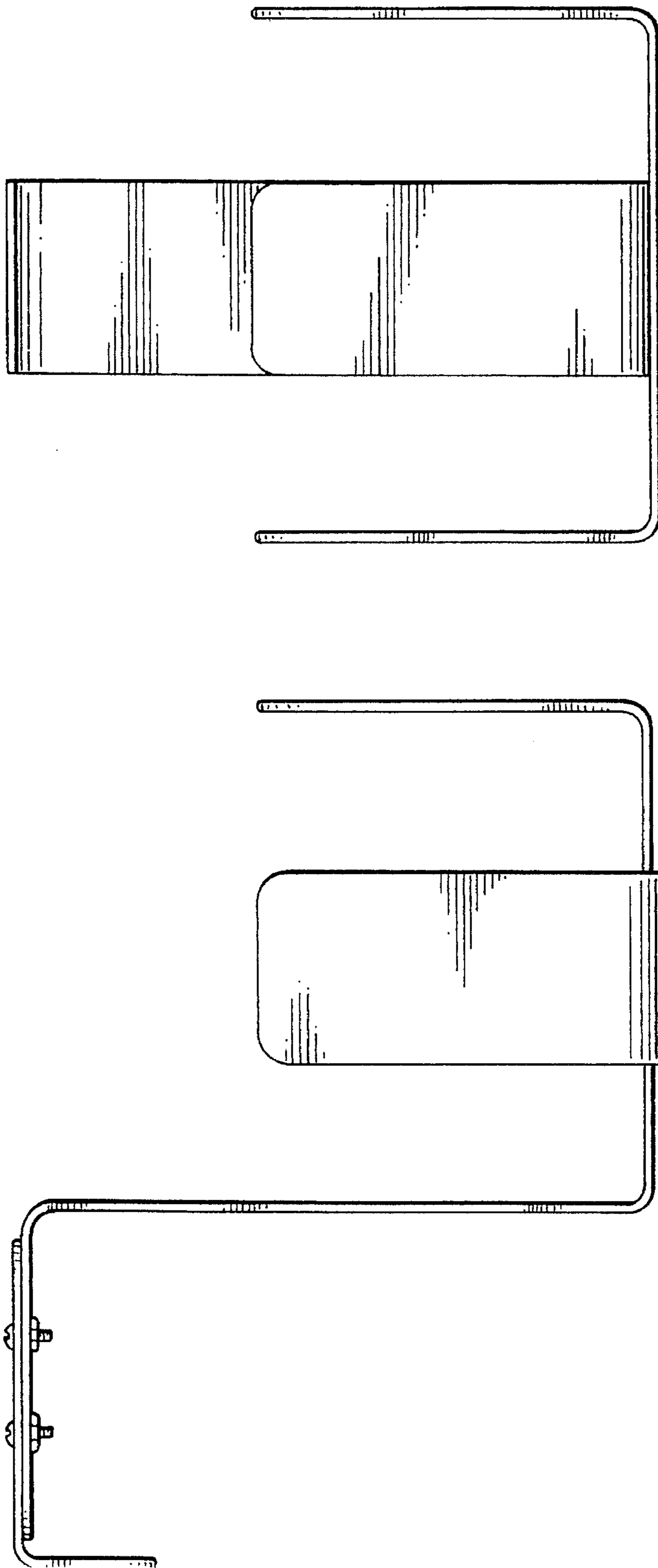

*Fig. 2*

*Fig. 1*

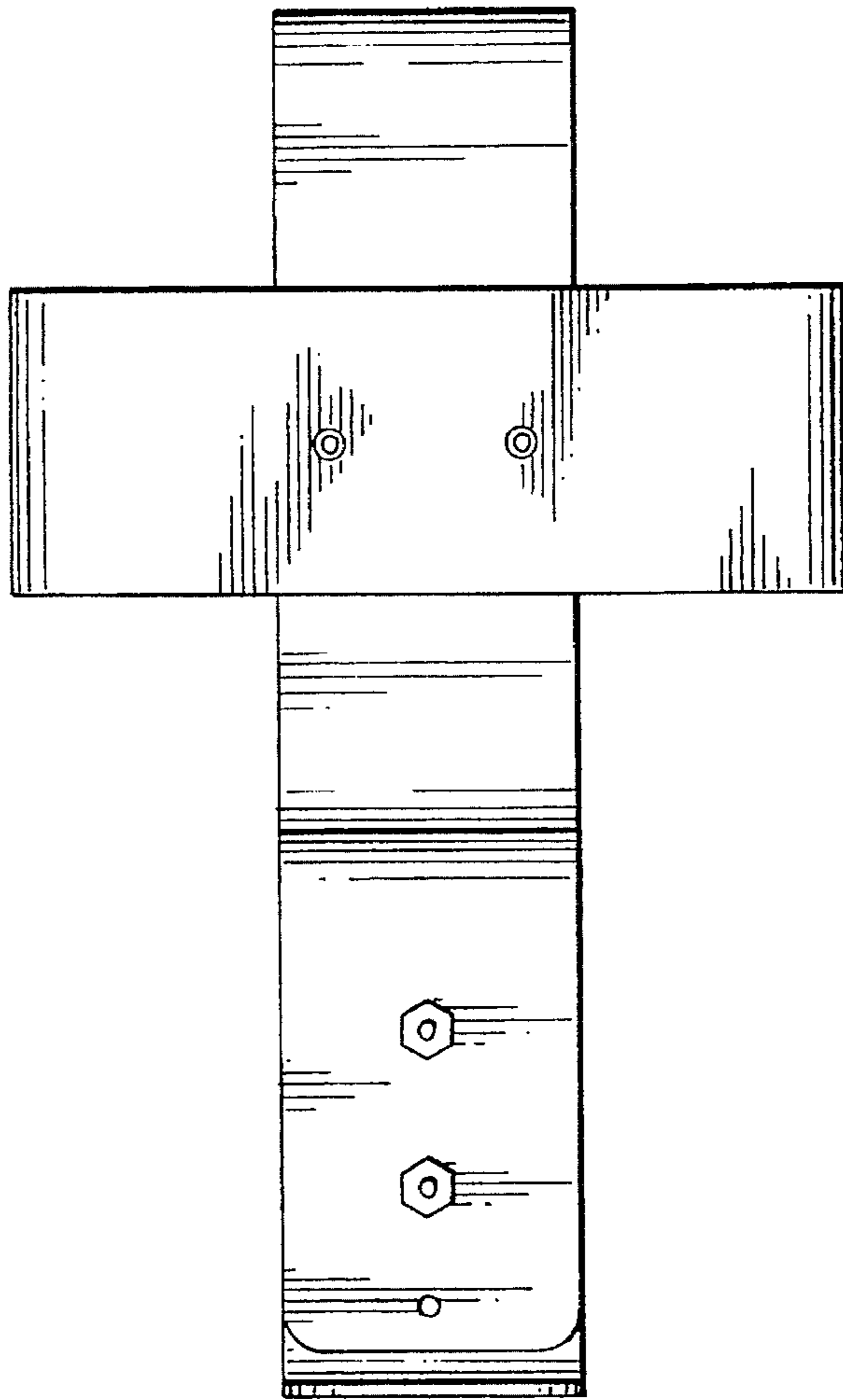

Fig. 4

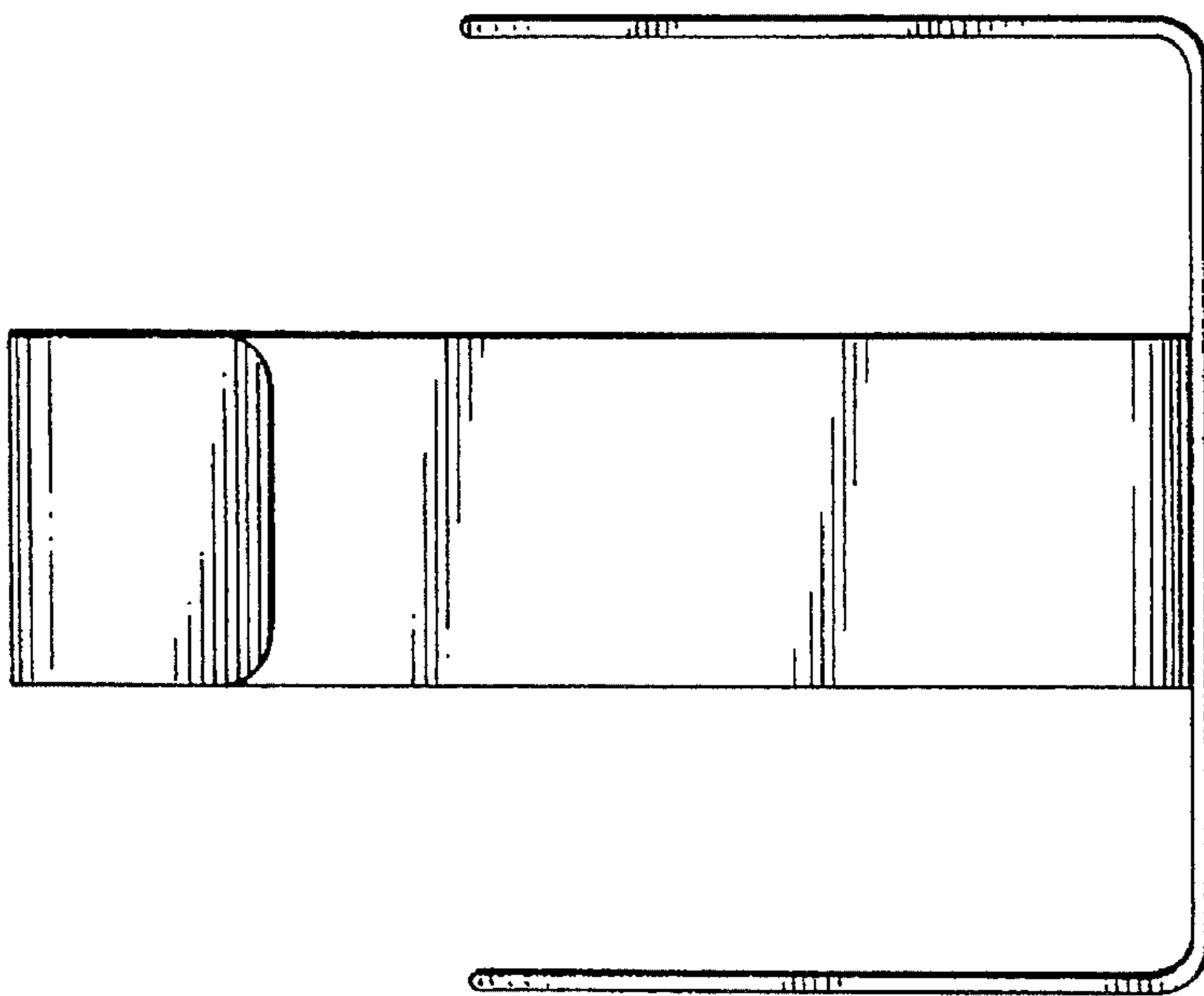
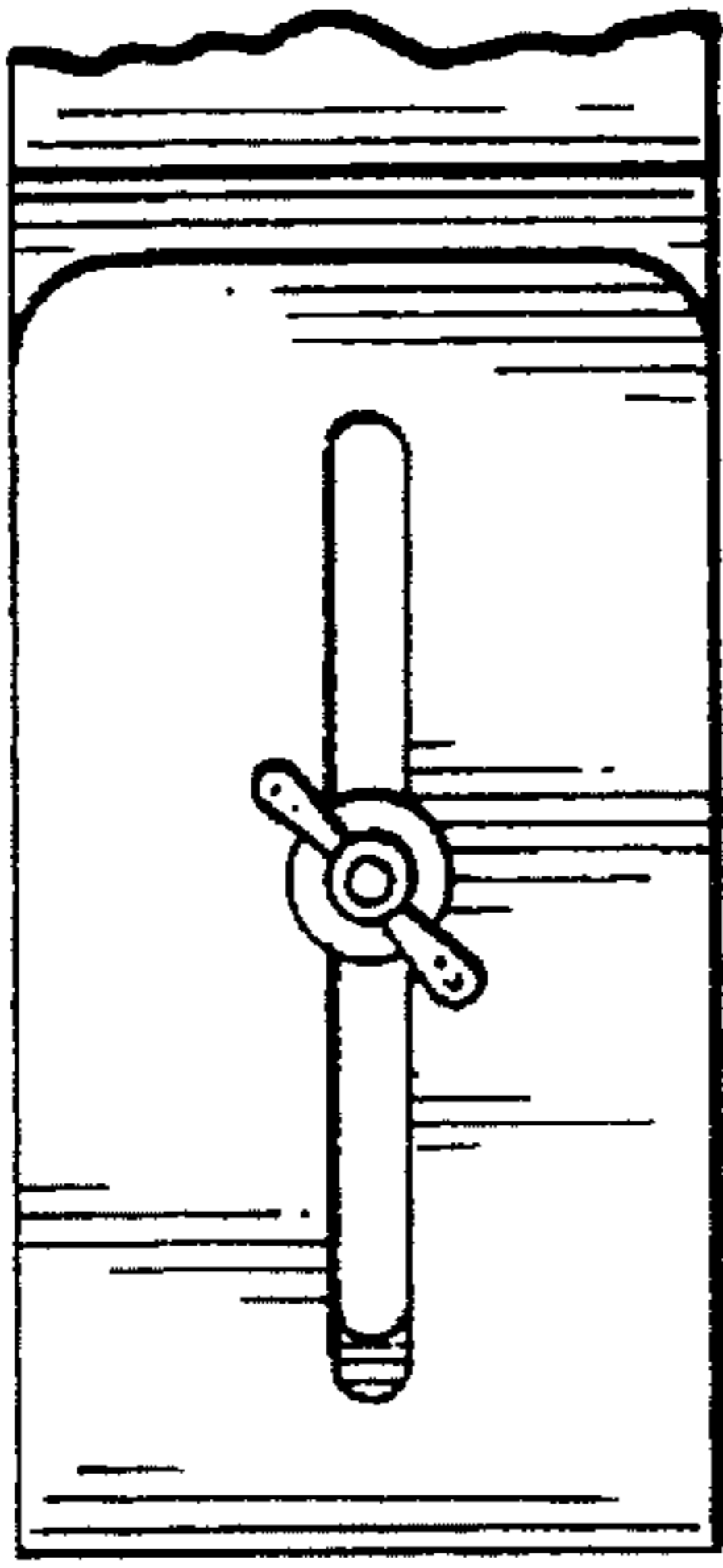
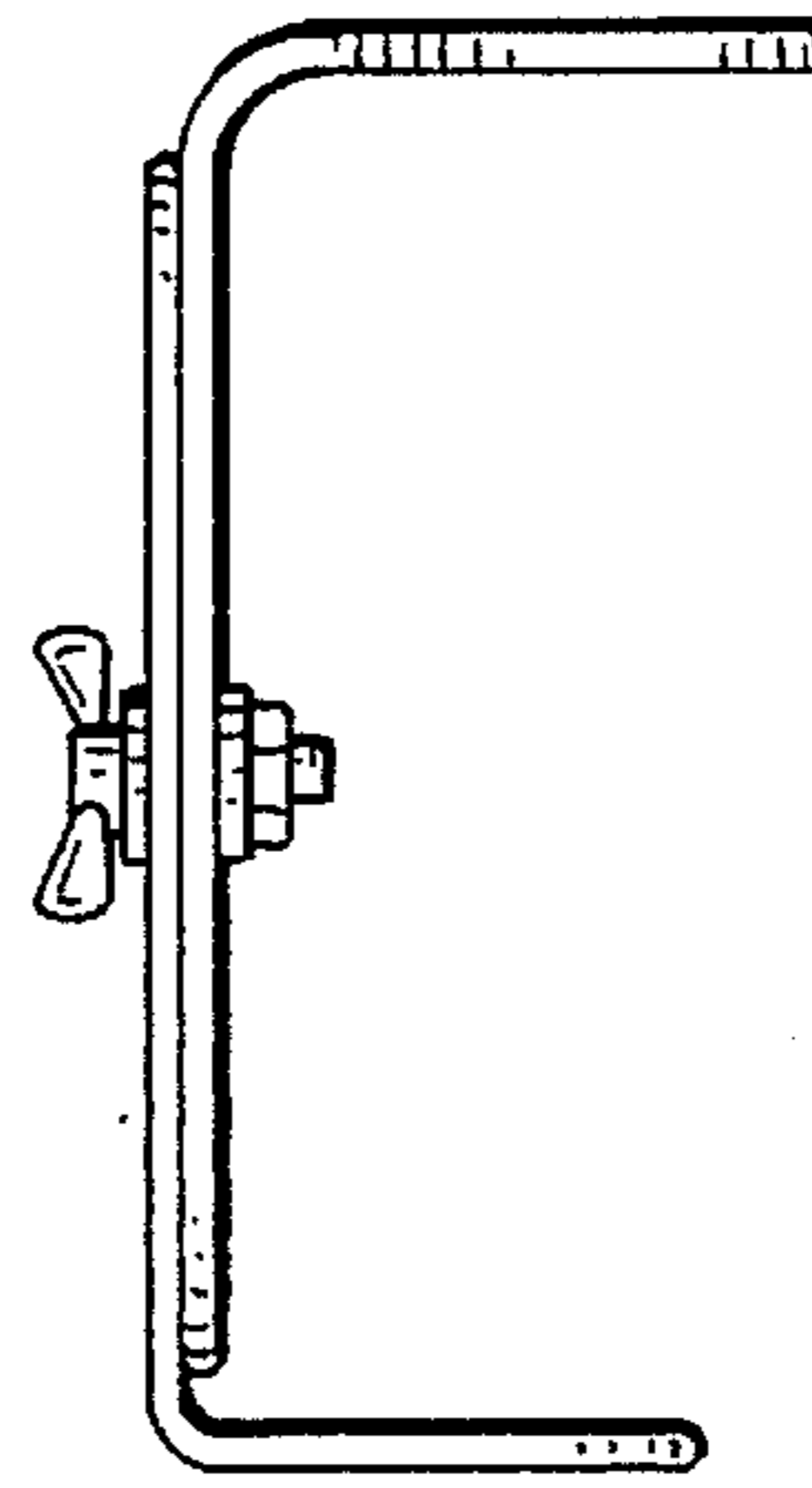

Fig. 3



*Fig. 6*



*Fig. 7*

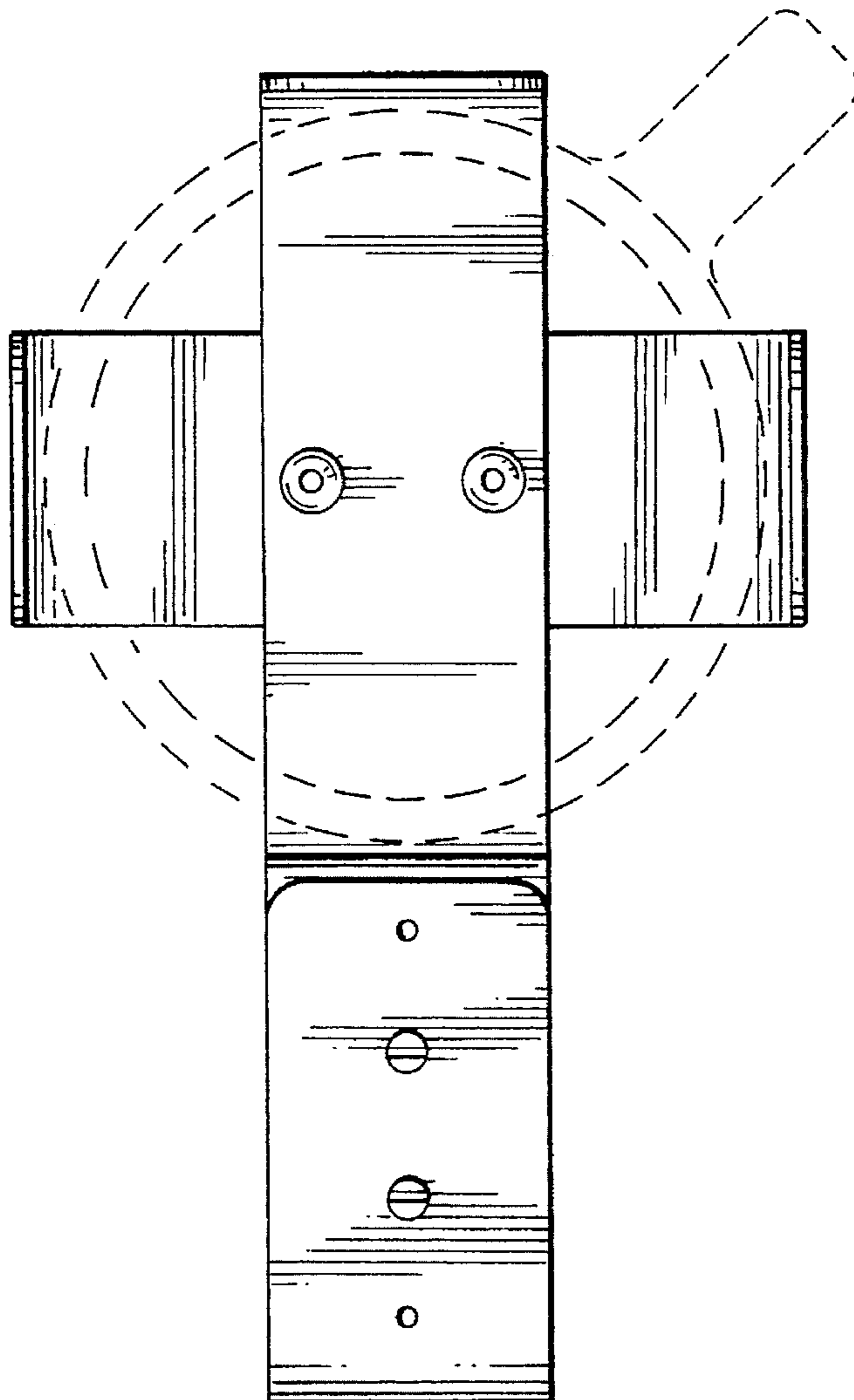

*Fig. 5*