



US00D367794S

United States Patent [19] Brawner

[11] Patent Number: **Des. 367,794**
[45] Date of Patent: ****Mar. 12, 1996**

[54] **DOCK PILING LOCKER**

[75] Inventor: **Jeffrey D. Brawner**, 29701 Elmgrove,
St. Clair Shores, Mich. 48082

[73] Assignee: **Jeffrey D. Brawner**, St. Clair Shores,
Mich.

[**] Term: **14 Years**

[21] Appl. No.: **33,246**

[22] Filed: **Jan. 9, 1995**

[52] U.S. Cl. **D6/559**

[58] Field of Search D6/553, 559-562;
D13/184; 312/100-101; 248/218.4

[56] **References Cited**

U.S. PATENT DOCUMENTS

D. 271,830 12/1983 Adenau D6/559
D. 333,402 2/1993 Ancona et al. D6/559

Primary Examiner—Brian N. Vinson

[57] **CLAIM**

The ornamental design for a dock piling locker, as shown and described.

DESCRIPTION

FIG. 1 is a top, front, and right side perspective view of a dock piling locker showing my new design in an opened position;

FIG. 2 is a top, rear, and right side perspective view thereof, the left side being a mirror image of the right side;

FIG. 3 is a rear elevational view thereof;

FIG. 4 is a horizontal cross-sectional view thereof, taken along line 4—4 of FIG. 3;

FIG. 5 is a top plan view thereof, the bottom being a mirror image of that shown; and,

FIG. 6 is a front elevational view thereof.

The broken-line disclosure of a portion of a dock piling in the views is for illustrative purposes only and forms no part of the claimed design.

1 Claim, 3 Drawing Sheets

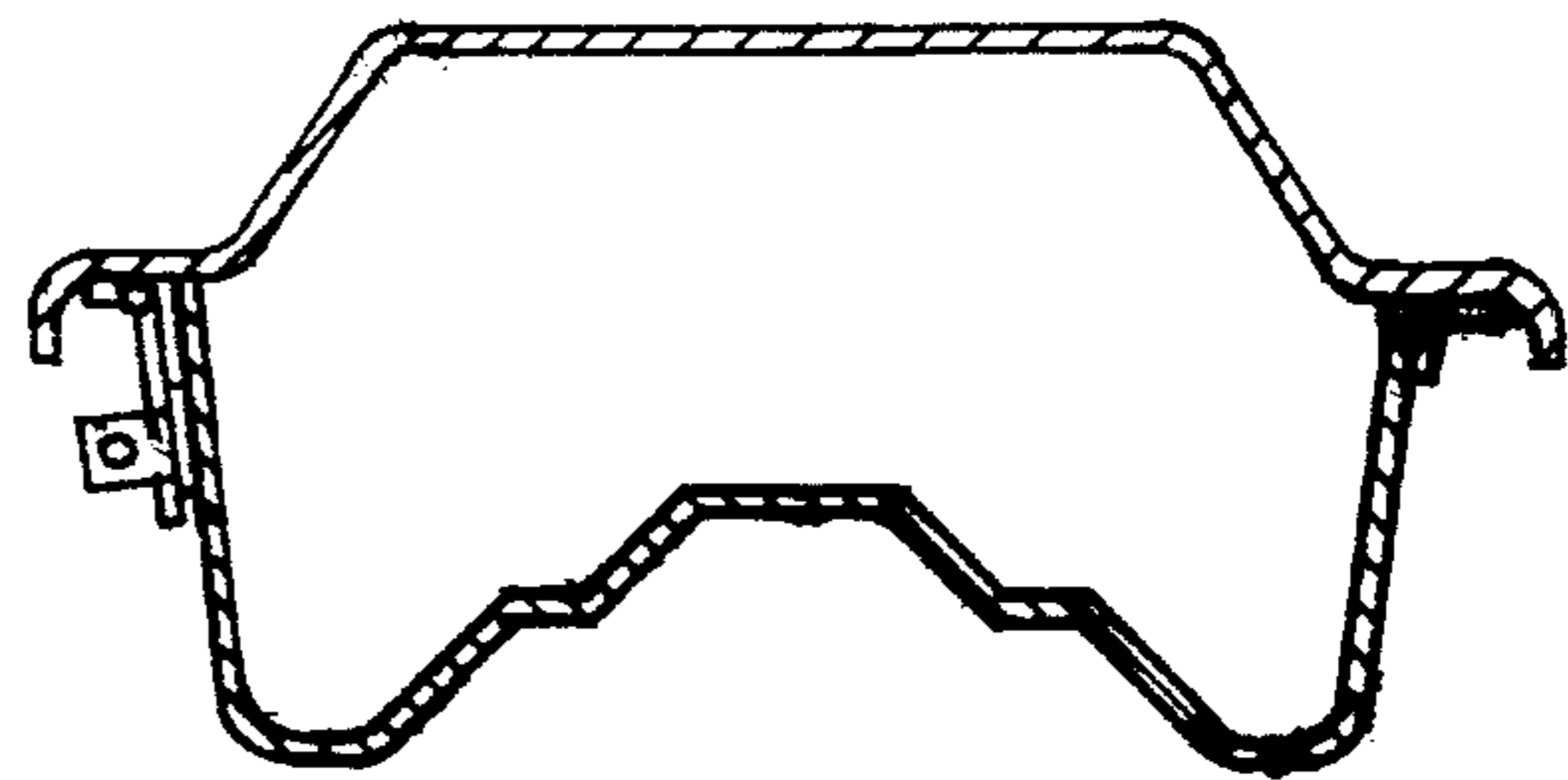
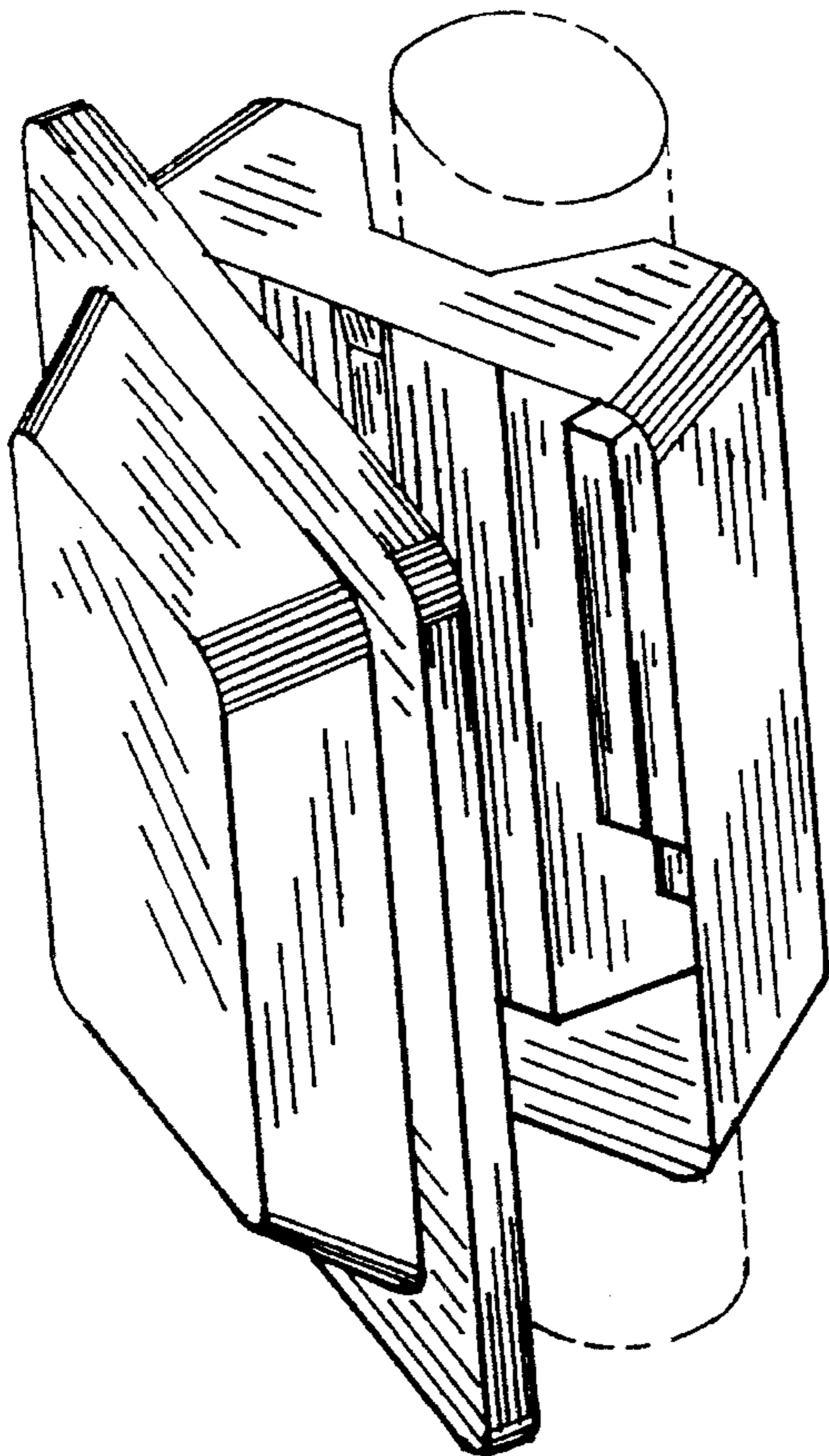

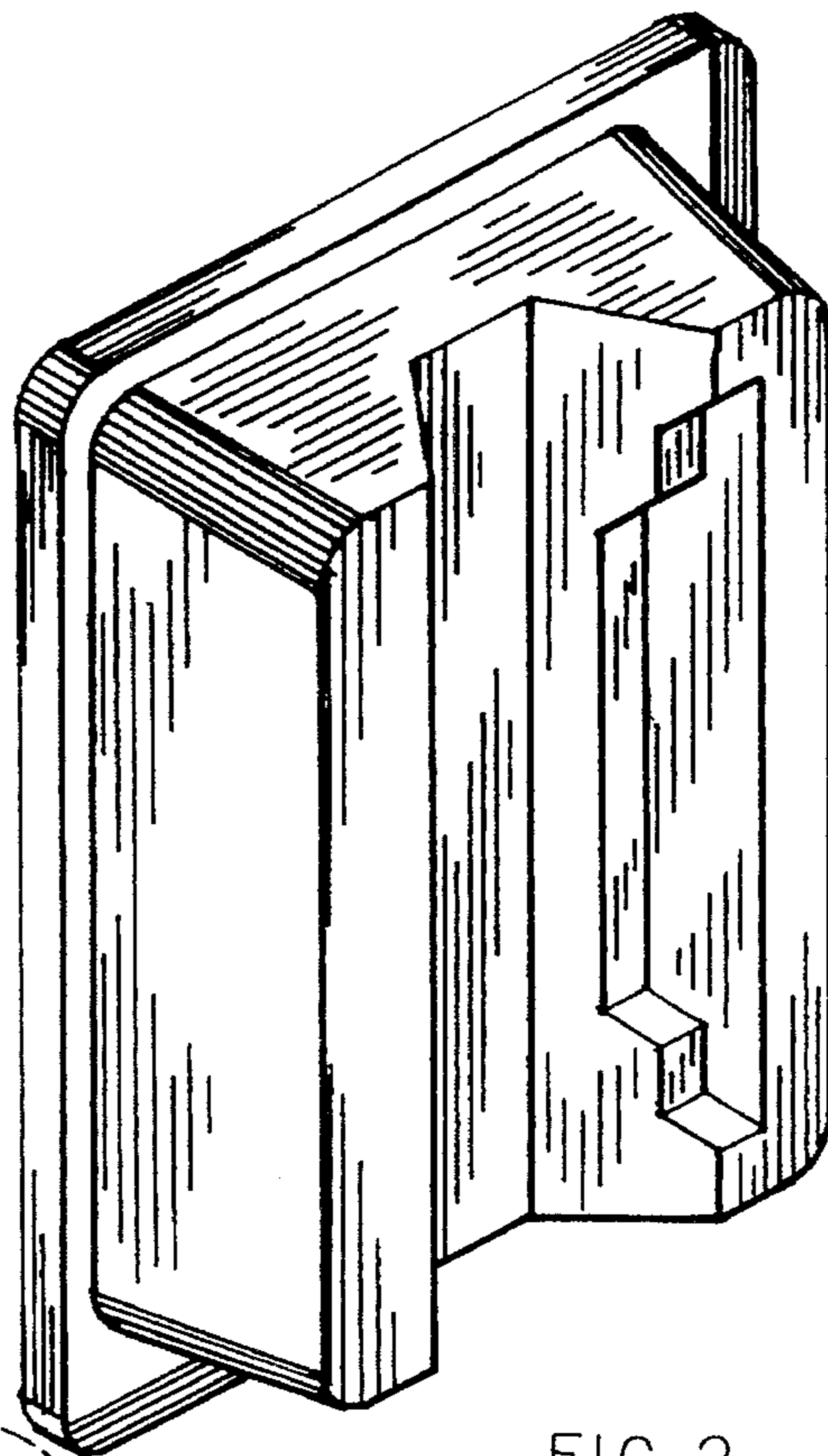

FIG. 2

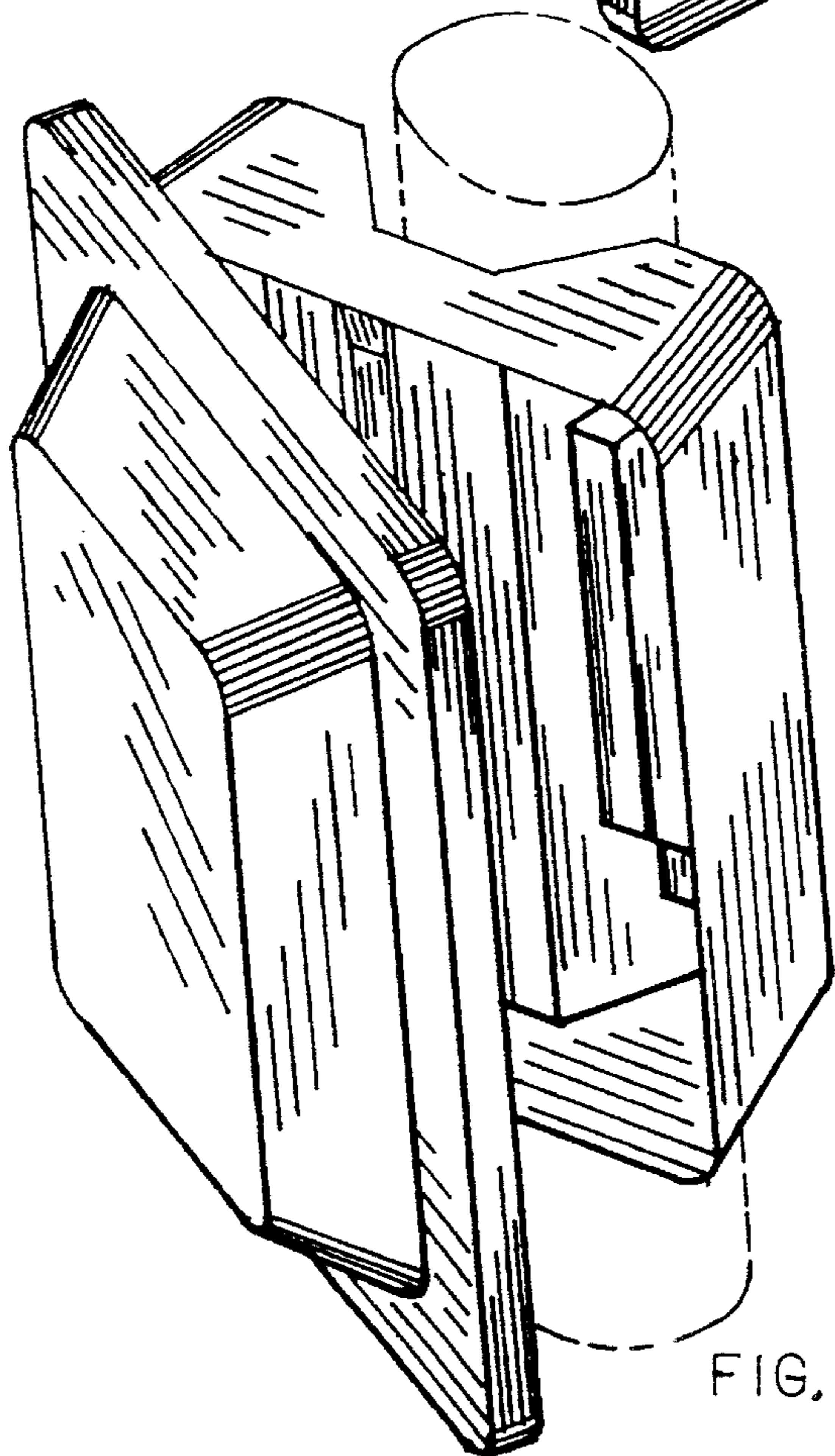

FIG. 1

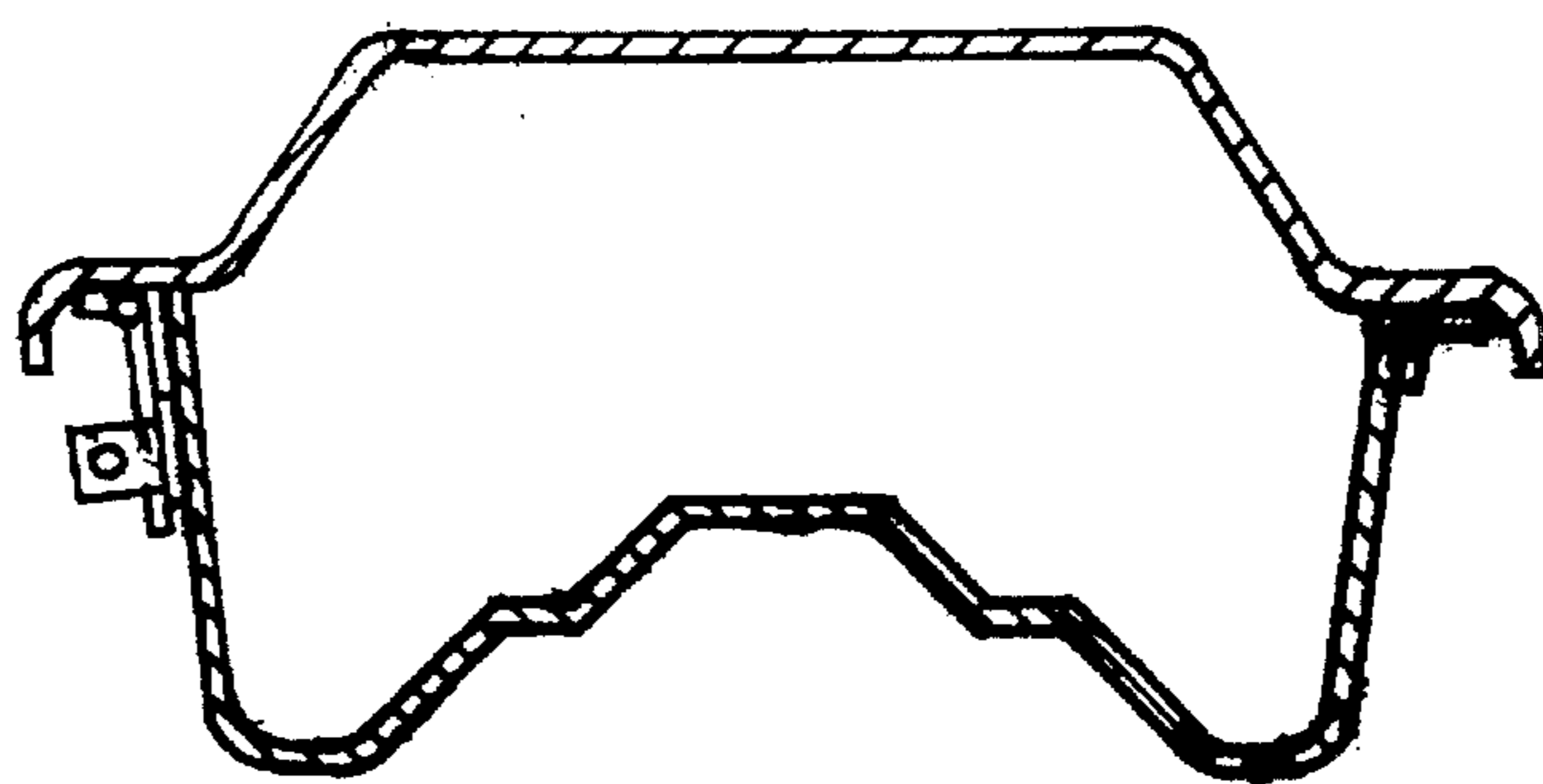

FIG. 4

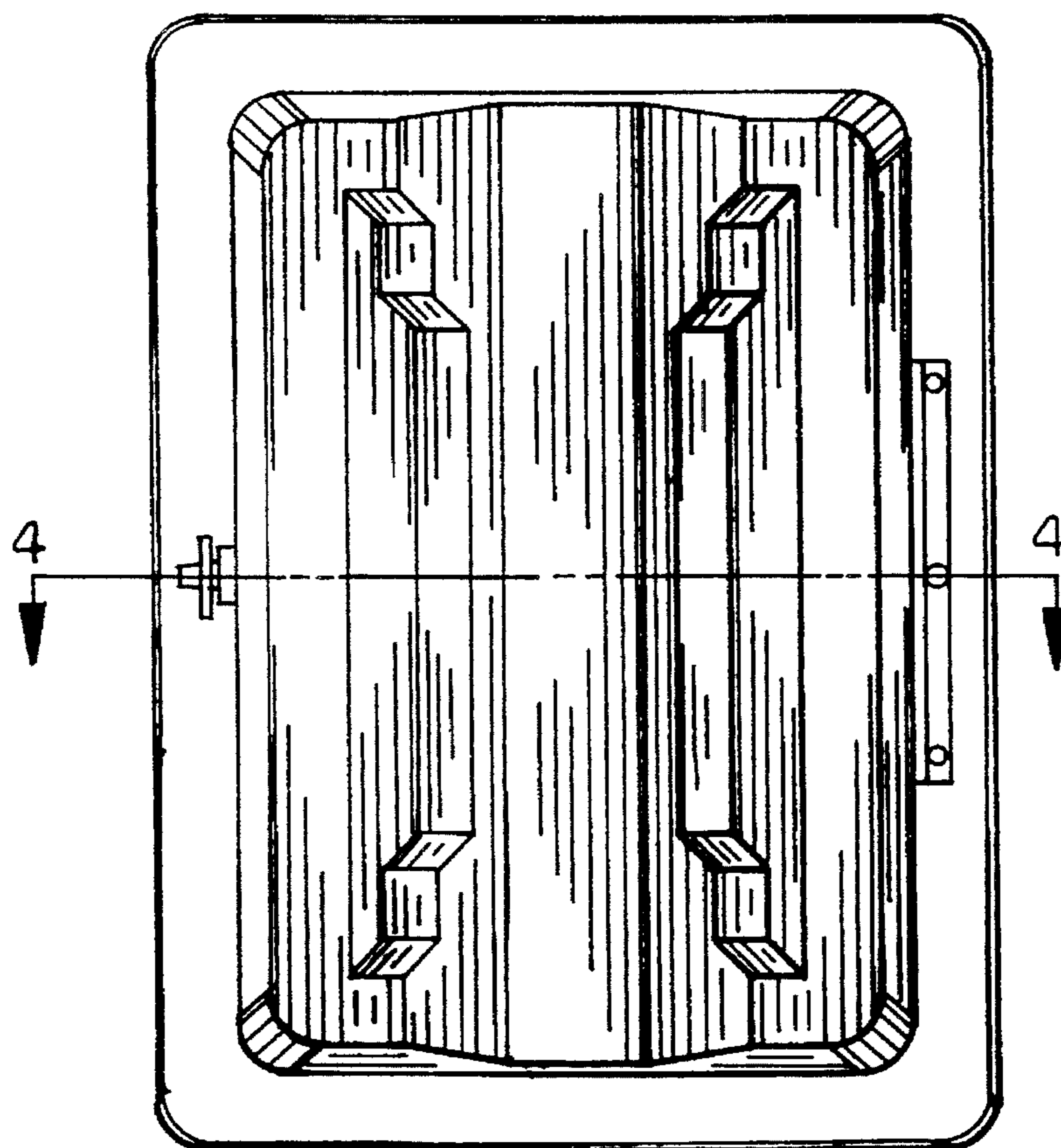

FIG. 3

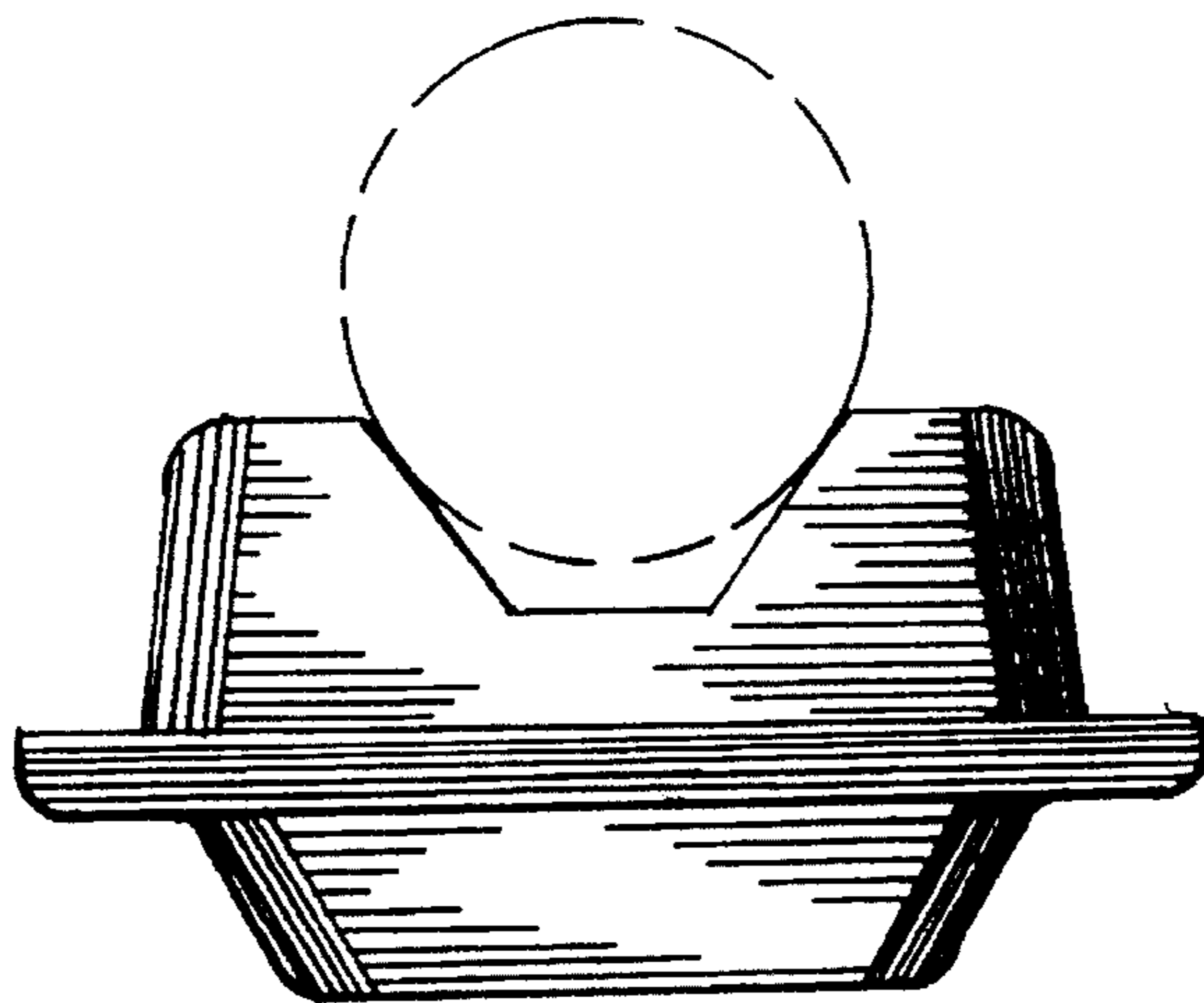

FIG. 5

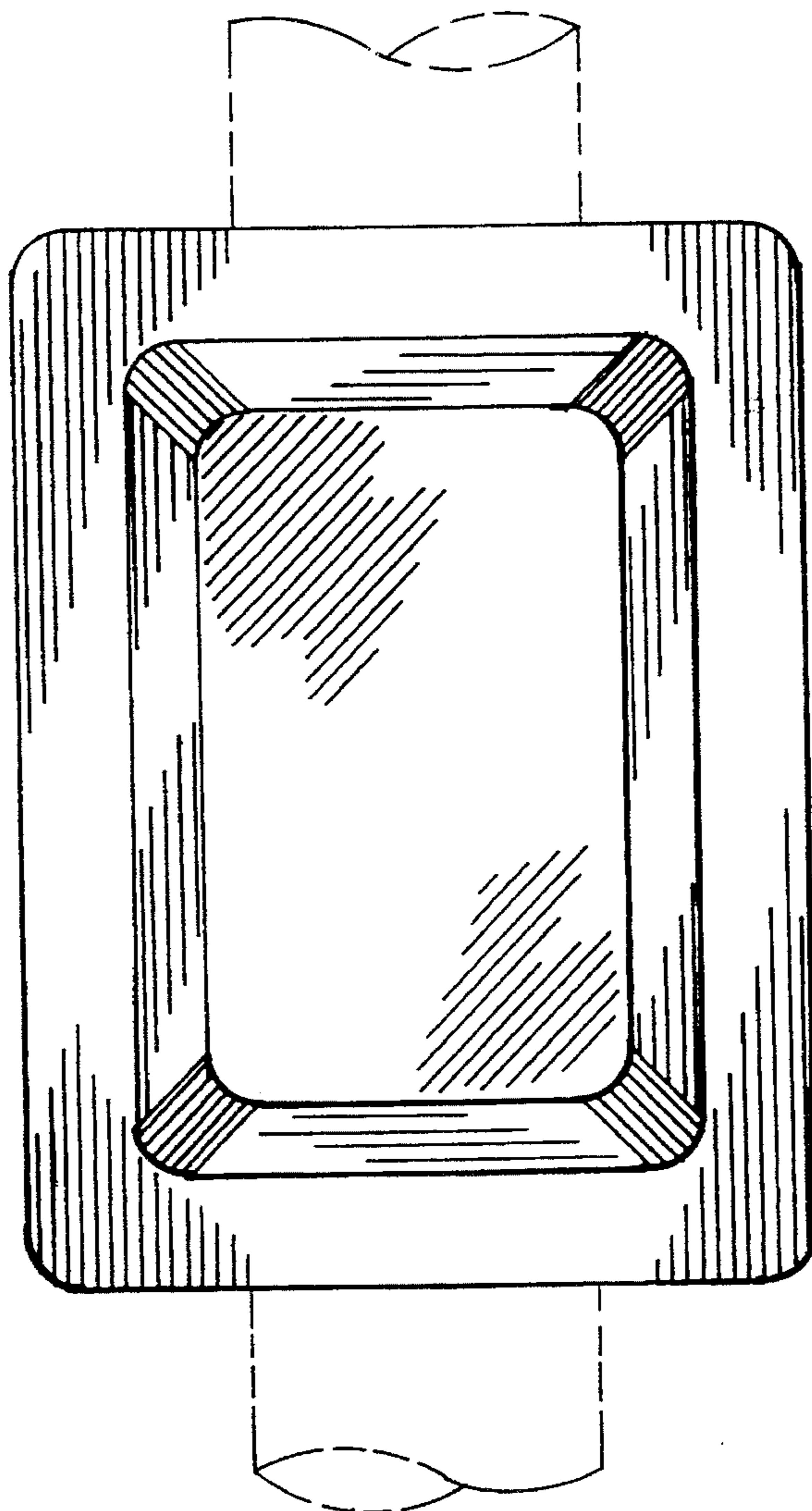

FIG. 6