



US00D367758S

United States Patent [19]

[11] Patent Number: **Des. 367,758**

Pernela

[45] Date of Patent: ****Mar. 12, 1996**

[54] CAMCORDER CARRYING STRAP

3,437,029 4/1969 Rydstedt .
3,790,049 2/1974 Bohanec .

[76] Inventor: **Ryan Pernela**, 23307 Peterson Dr.,
Mountlake Terrace, Wash. 98043

Primary Examiner—Celia Murphy
Attorney, Agent, or Firm—James A. Hudak

[**] Term: **14 Years**

[57] CLAIM

[21] Appl. No.: **30,070**

The ornamental design for a camcorder carrying strap, as shown and described.

[22] Filed: **Oct. 21, 1994**

[52] U.S. Cl. **D3/267; D3/263**

DESCRIPTION

[58] Field of Search D3/263, 267, 268,
D3/327; D16/214, 234, 235, 136, 339;
224/908, 219; 294/158, 139; 354/286, 293

FIG. 1 is a perspective view of the camcorder carrying strap showing my new design;
FIG. 2 is a left side elevational view thereof;
FIG. 3 is a right side elevational view thereof;
FIG. 4 is a front elevational view thereof;
FIG. 5 is a rear elevational view thereof;
FIG. 6 is a top plan view thereof; and,
FIG. 7 is a bottom plan view thereof.;

[56] References Cited

U.S. PATENT DOCUMENTS

D. 151,643	11/1948	Mackenzie	D3/263
D. 209,050	10/1967	Saari et al.	D3/263
D. 241,481	9/1976	Wareham	D3/268
D. 275,819	10/1984	Leiserson	D3/267
2,771,014	10/1956	Tolcher	.	

1 Claim, 3 Drawing Sheets

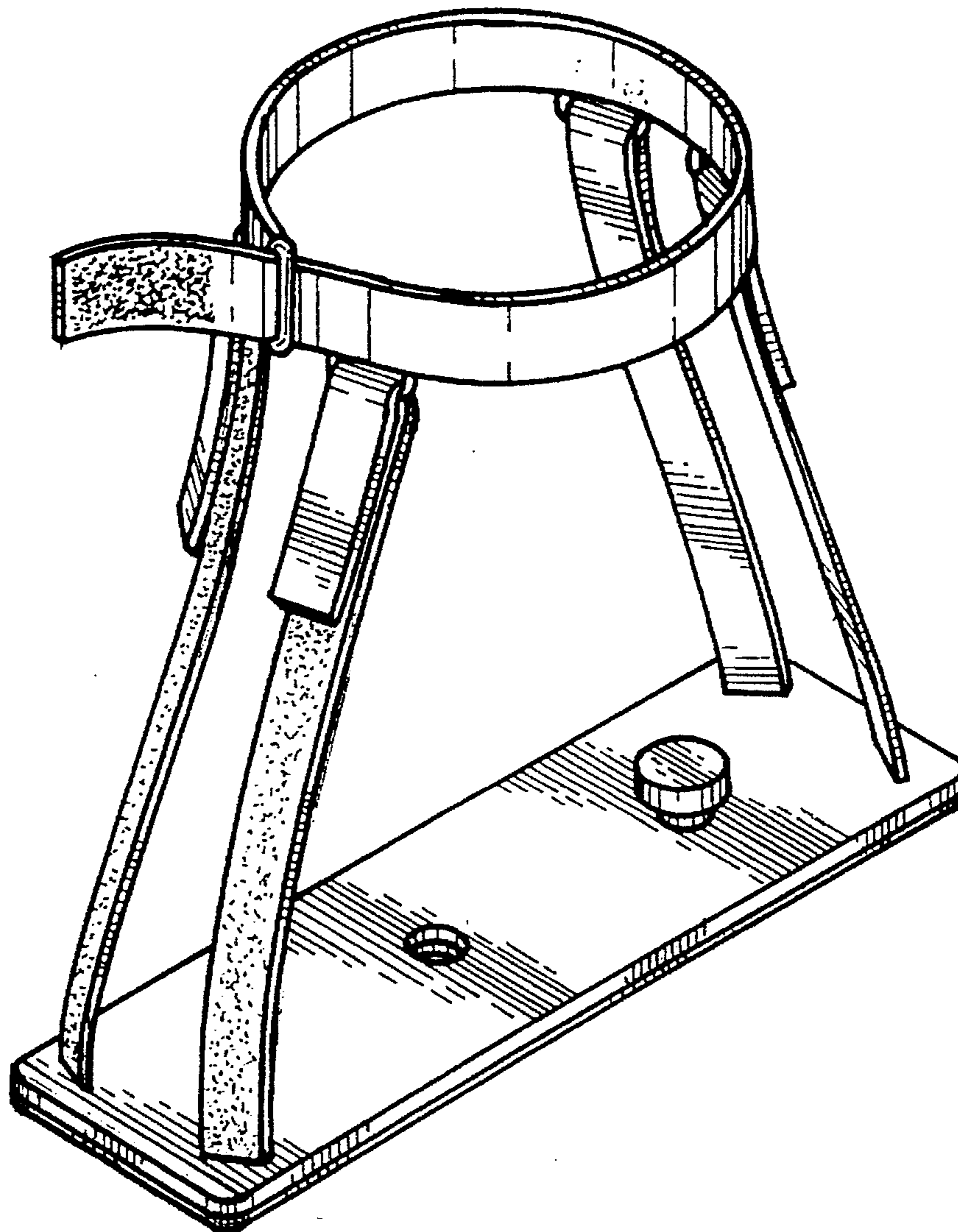

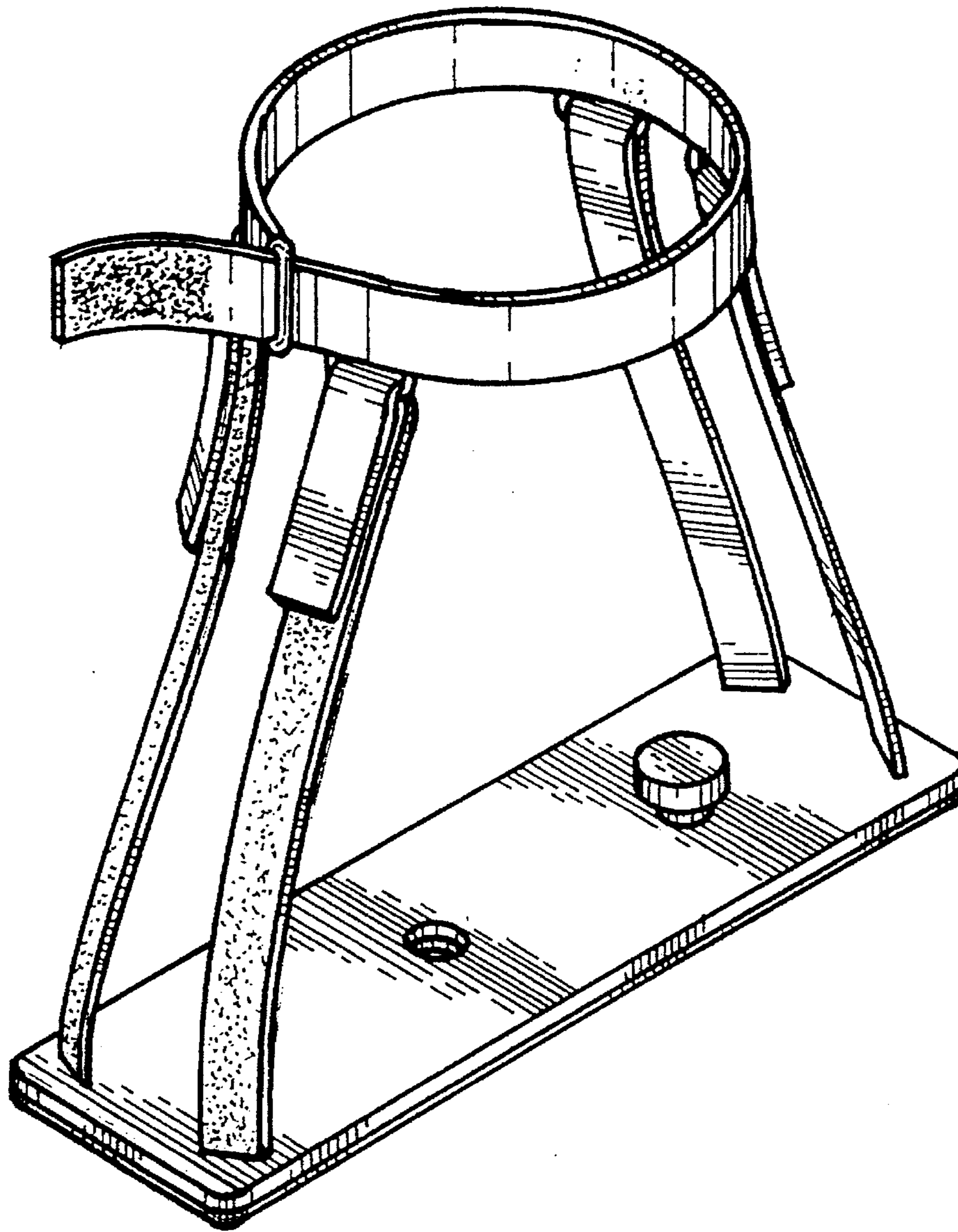

FIG. 1

FIG. 4

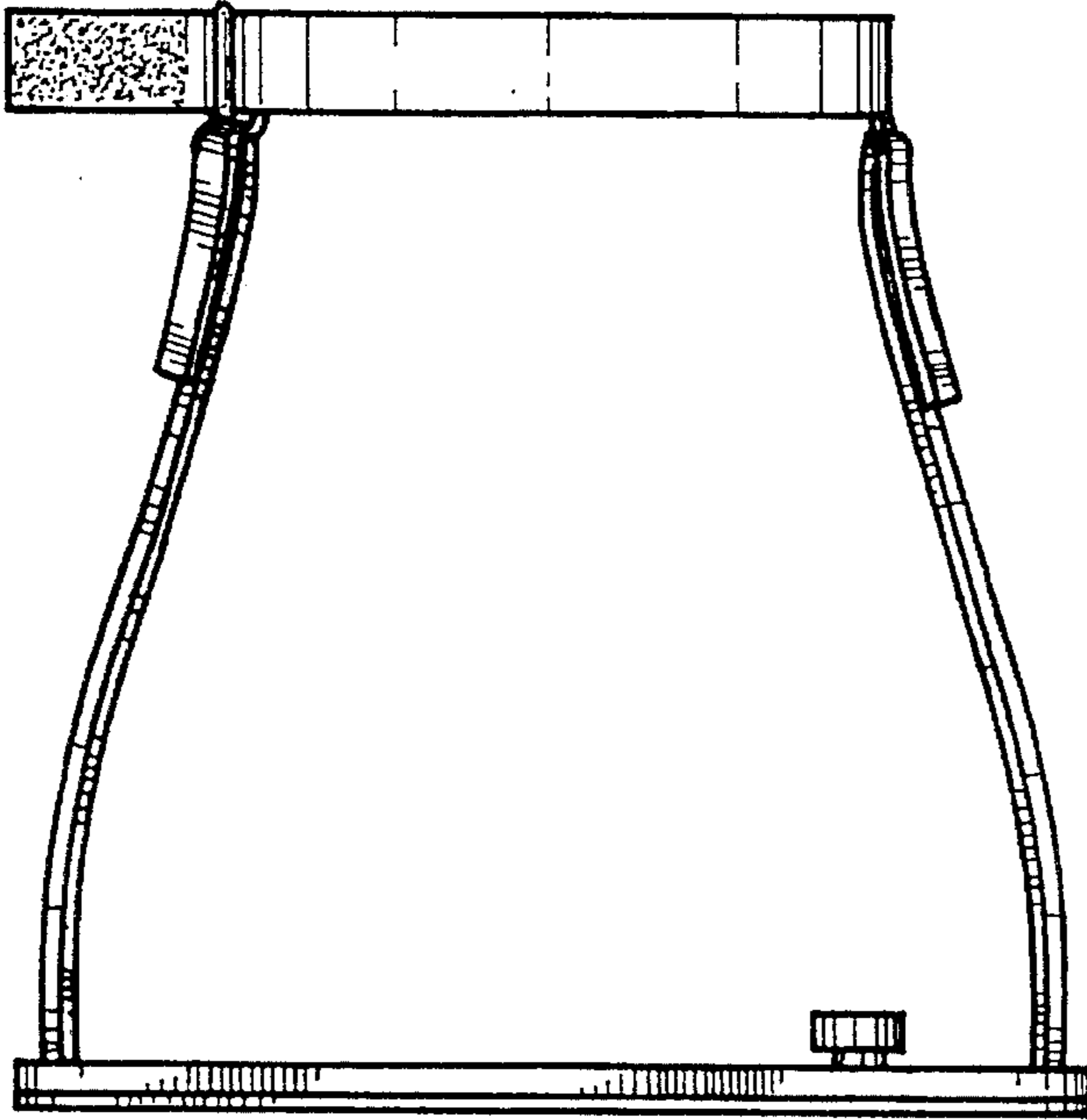

FIG. 2

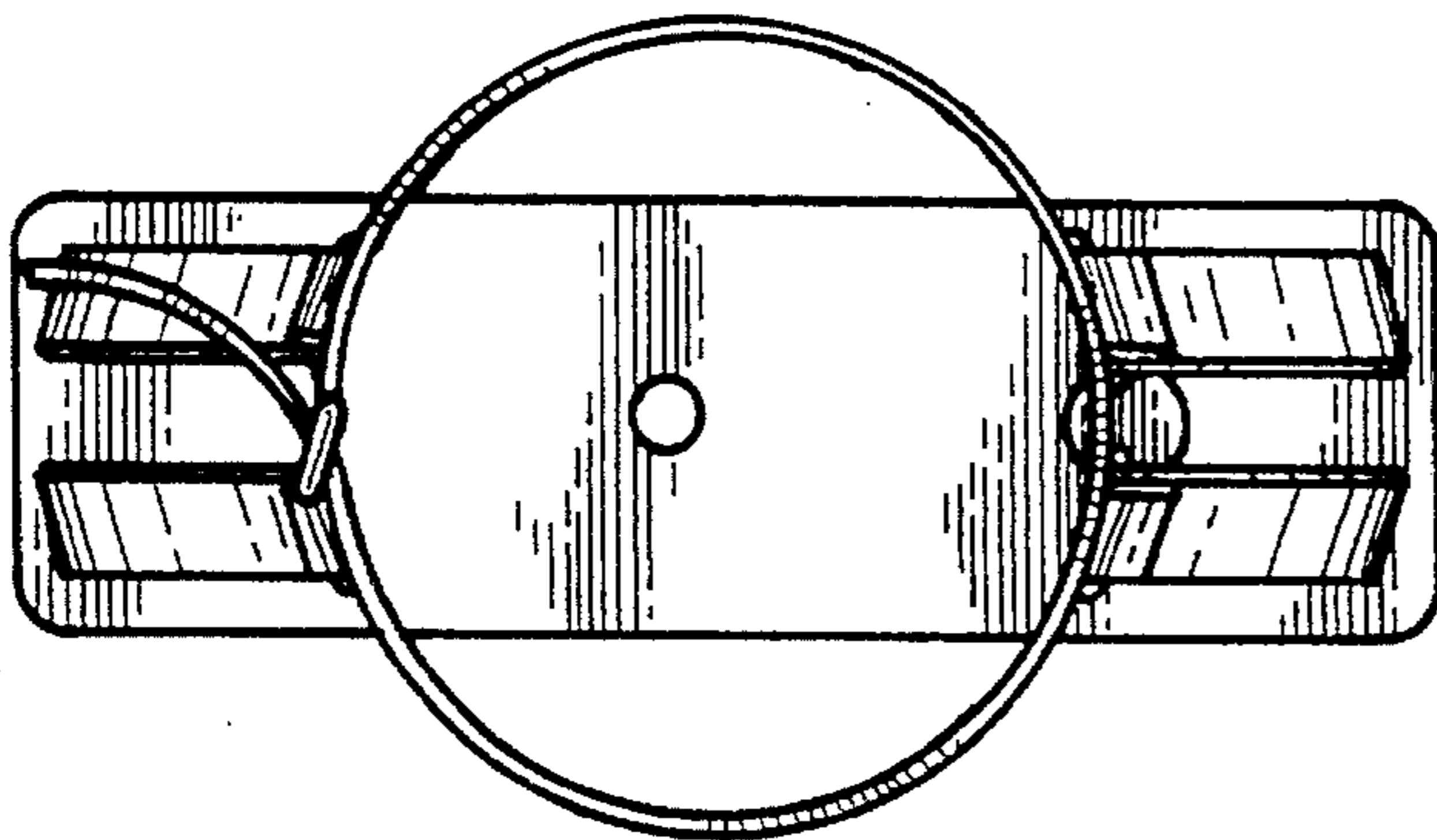
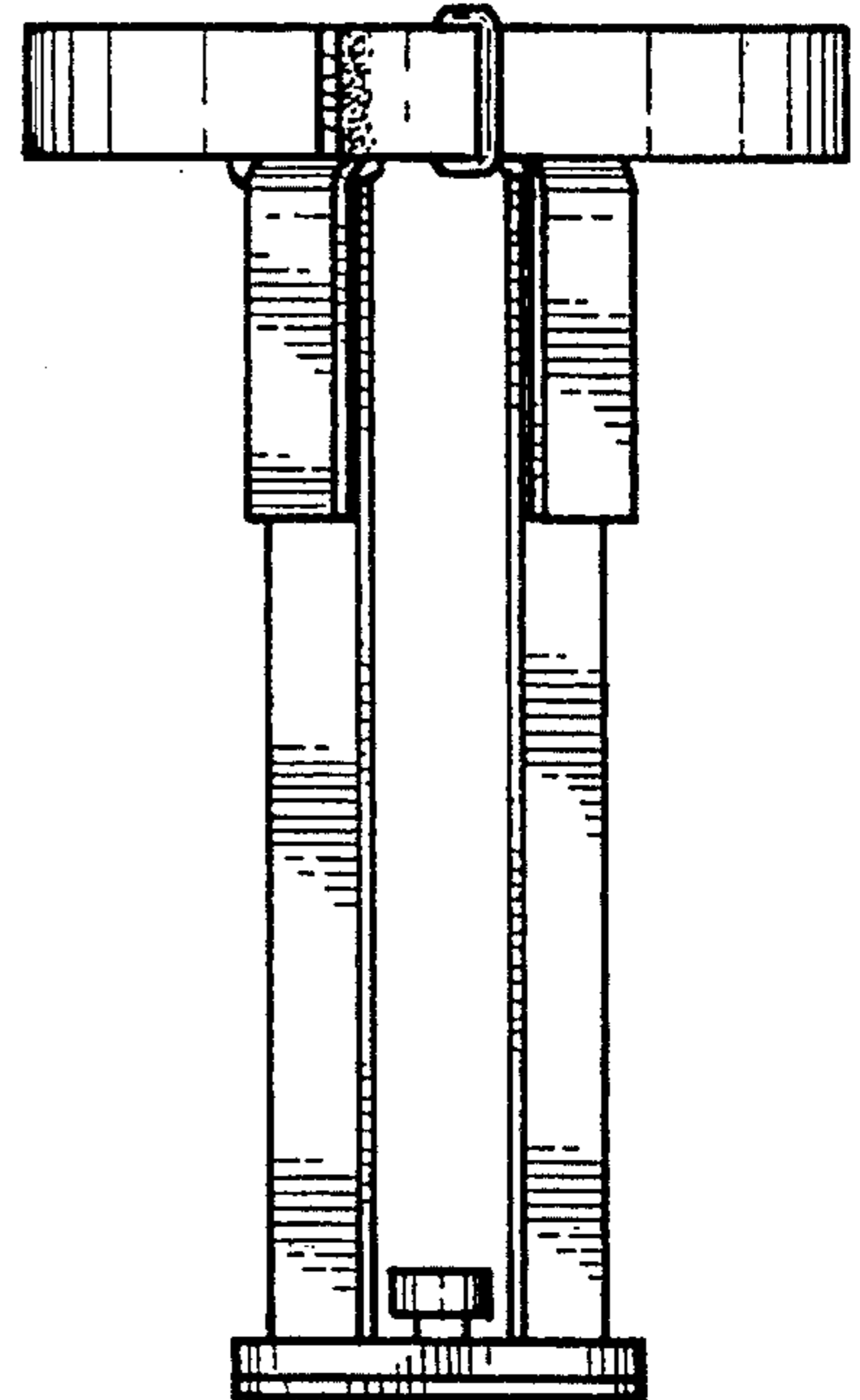

FIG. 6

FIG. 3

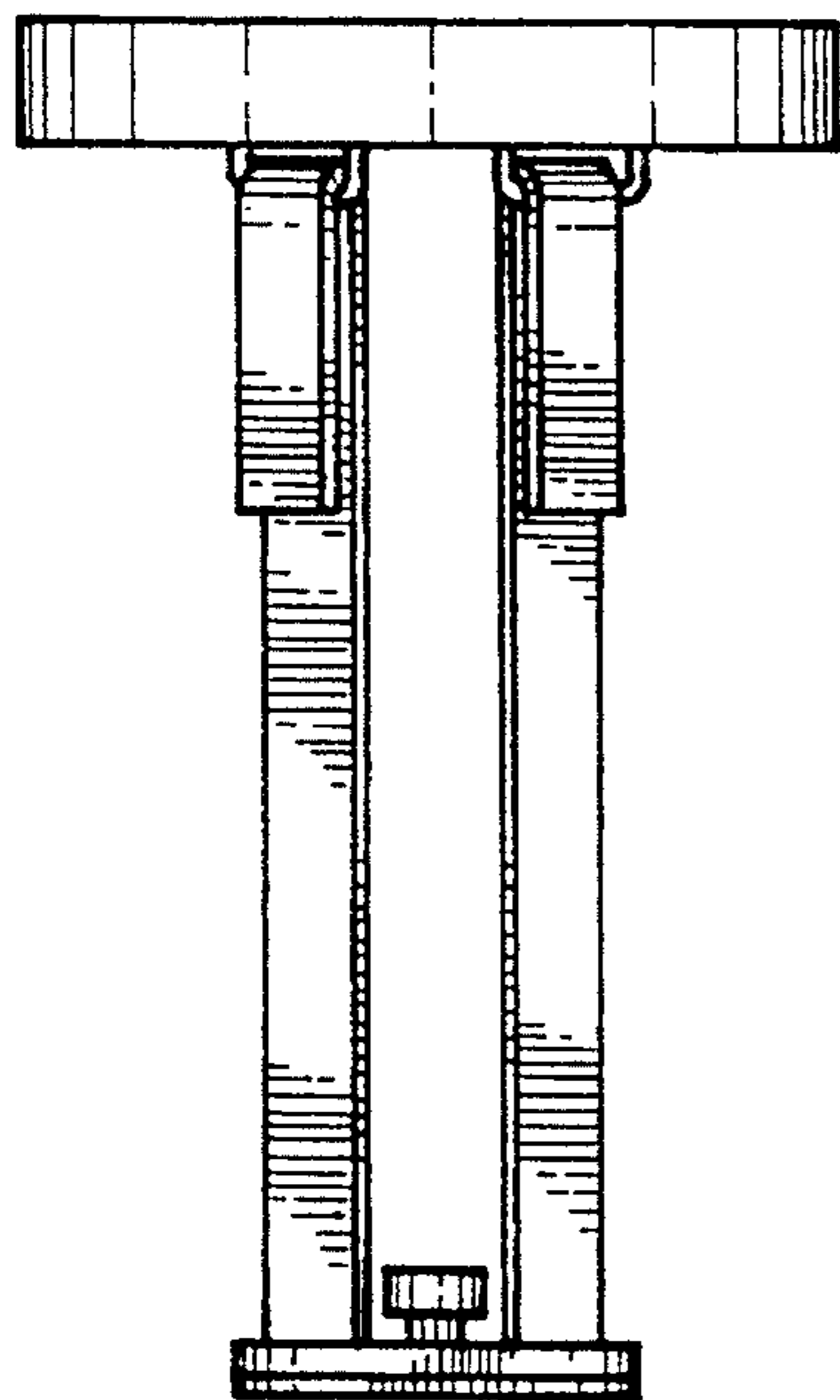

FIG. 5

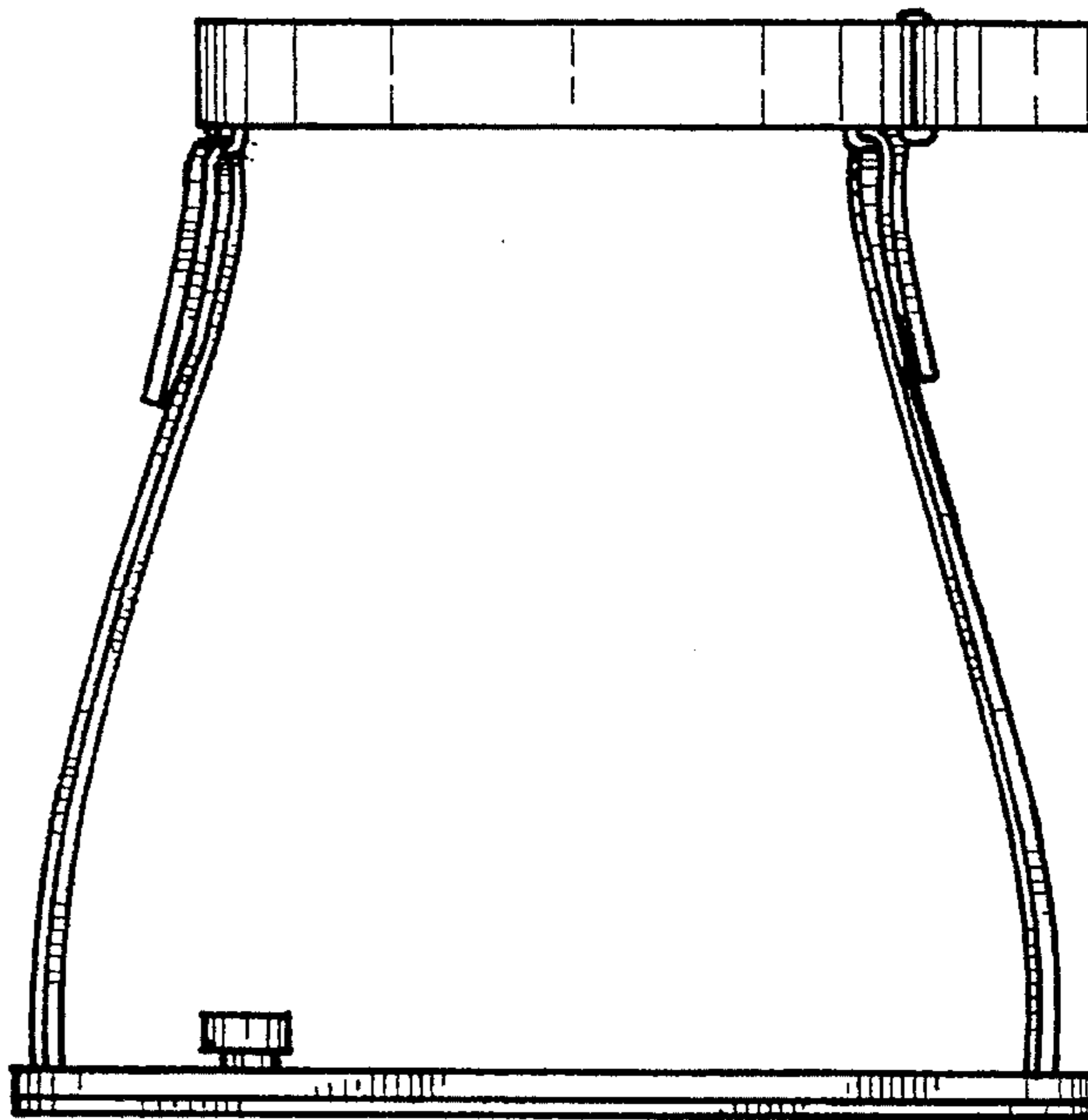

FIG. 7

