



US00D367715S

United States Patent [19]
Joubert

[11] **Patent Number: Des. 367,715**

[45] **Date of Patent: **Mar. 5, 1996**

[54] **BUILDING ELEMENT**

[76] Inventor: **Johannes W. Joubert**, P.O. Box 3685,
Pietersburg, 0700, South Africa

[**] Term: **14 Years**

[21] Appl. No.: **26,913**

[22] Filed: **Aug. 8, 1994**

[30] **Foreign Application Priority Data**

Feb. 10, 1994 [ZA] South Africa 94/0072

Feb. 10, 1994 [ZA] South Africa 94/0073

[52] **U.S. Cl.** **D25/114**

[58] **Field of Search** D25/114; 52/596,
52/605, 608

[56] **References Cited**

U.S. PATENT DOCUMENTS

D. 305,570 1/1990 Sakata D25/114

1,317,183 9/1919 Straight D25/114

2,154,213 4/1939 Noce 52/608

4,936,712 6/1995 Glickman 52/608

Primary Examiner—Doris Clark

Attorney, Agent, or Firm—Ladas & Parry

[57] **CLAIM**

The ornamental design for a building element, as shown and described.

DESCRIPTION

FIG. 1 shows a perspective view of one embodiment of a building element;

FIG. 2 shows a right hand side view of the building element of FIG. 1;

FIG. 3 shows a left hand side view of the building element of FIG. 1.

FIG. 4 shows a top plan view of the building element;

FIG. 5 shows an bottom plan view of the building element;

FIG. 6 shows a front view of the building element;

FIG. 7 shows a rear view of the building element;

FIG. 8 shows a perspective view of a second embodiment of the building element;

FIG. 9 shows a right hand side view of the embodiment shown in FIG. 8;

FIG. 10 shows a left hand side view of the embodiment shown in FIG. 8;

FIG. 11 shows a top plan view of the embodiment shown in FIG. 8;

FIG. 12 shows an bottom plan view of the embodiment shown in FIG. 8;

FIG. 13 shows a front view of the embodiment shown in FIG. 8;

FIG. 14 shows a rear view of the embodiment shown in FIG. 8;

FIG. 15 shows a right hand side view of a third embodiment of the building element;

FIG. 16 shows a front view of the embodiment shown in FIG. 15;

FIG. 17 shows a left hand side view of a fourth embodiment of the building element;

FIG. 18 shows a front view of the embodiment shown in FIG. 17;

FIG. 19 shows a left hand side view of a fifth embodiment of the building element; and,

FIG. 20 shows a front view of the embodiment shown in FIG. 19.

The right hand side views of the embodiments shown in FIGS. 15, 17 and 19 are mirror images of the left hand side view shown in FIGS. 15, 17 and 19. Further, the top plan view, bottom plan view and rear view of the embodiment shown in FIG. 15 will be similar to FIGS. 4, 5 and 7, respectively. In addition, the top plan view, bottom plan view and rear view of the embodiment shown in FIGS. 17 and 19 will be similar to FIGS. 11, 12 and 14, respectively.

1 Claim, 7 Drawing Sheets

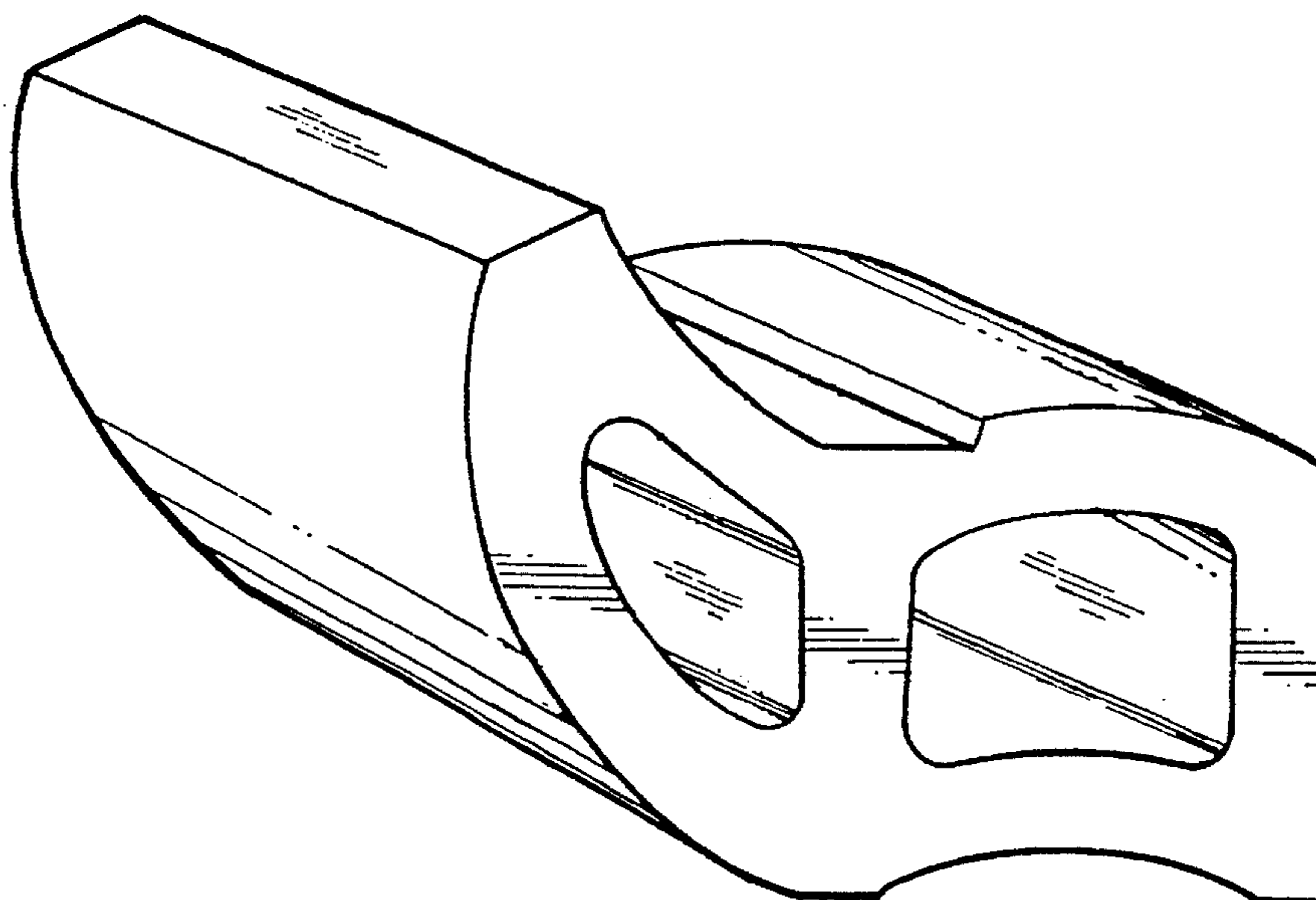

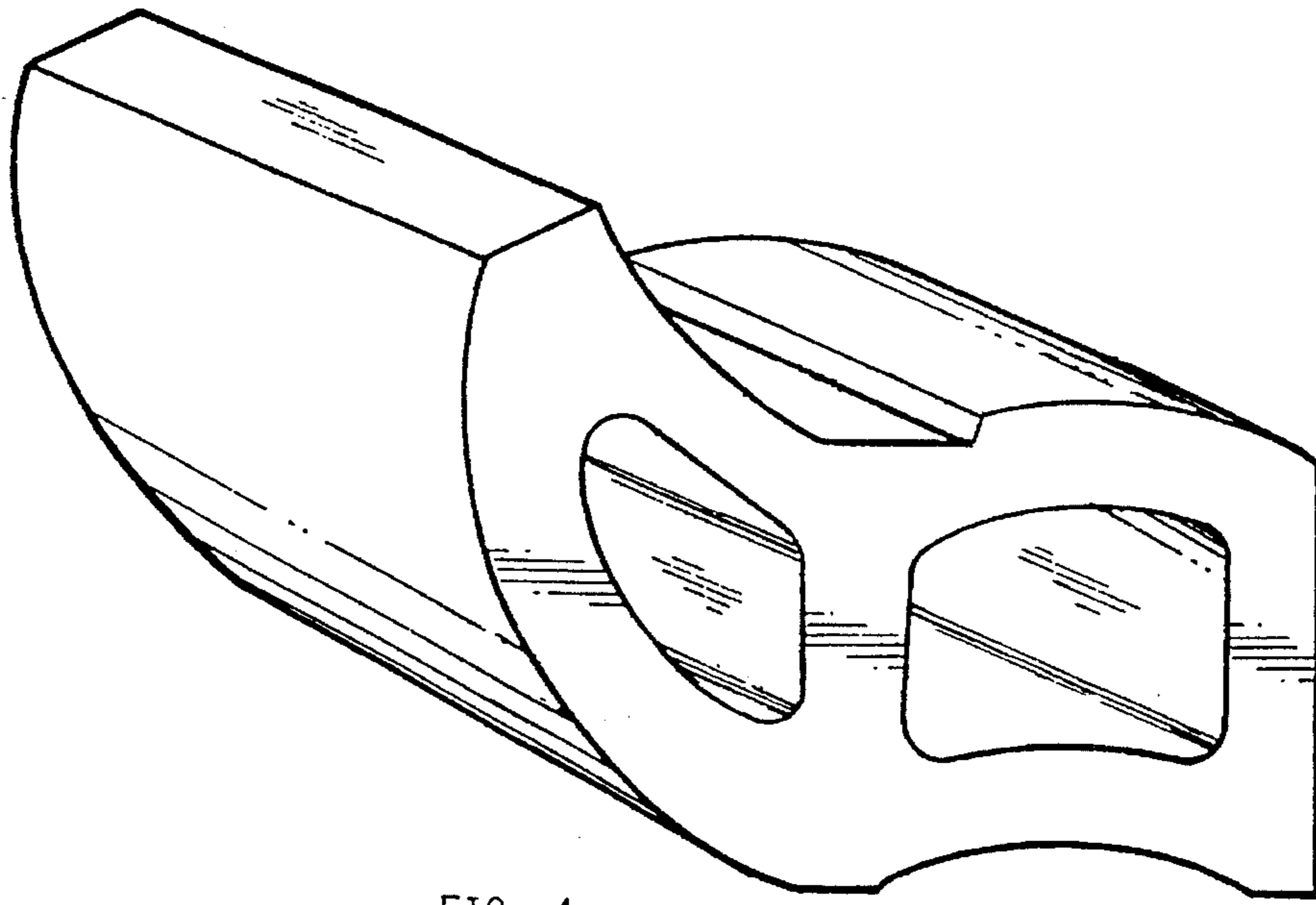

FIG. 1

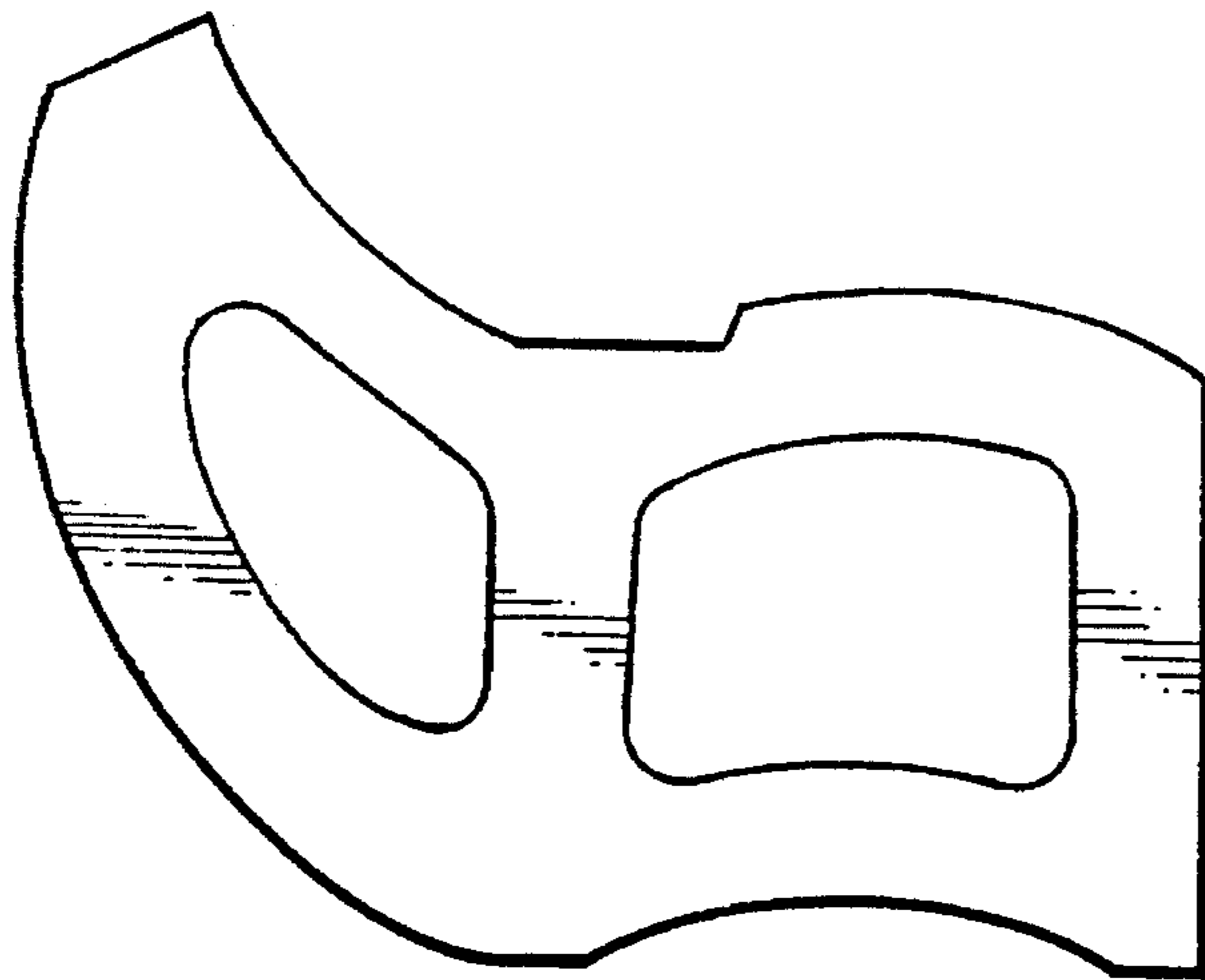

FIG. 2

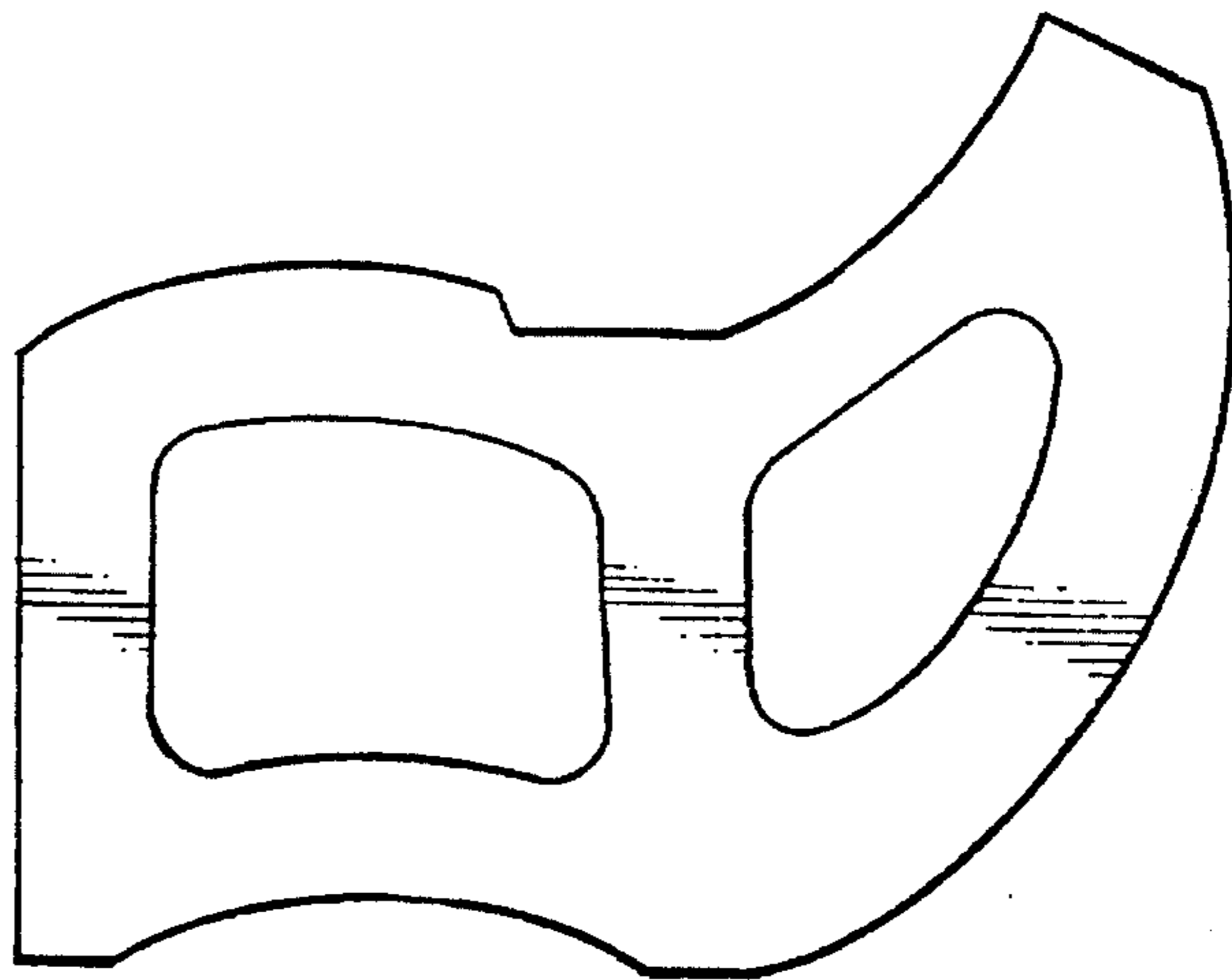

FIG. 3

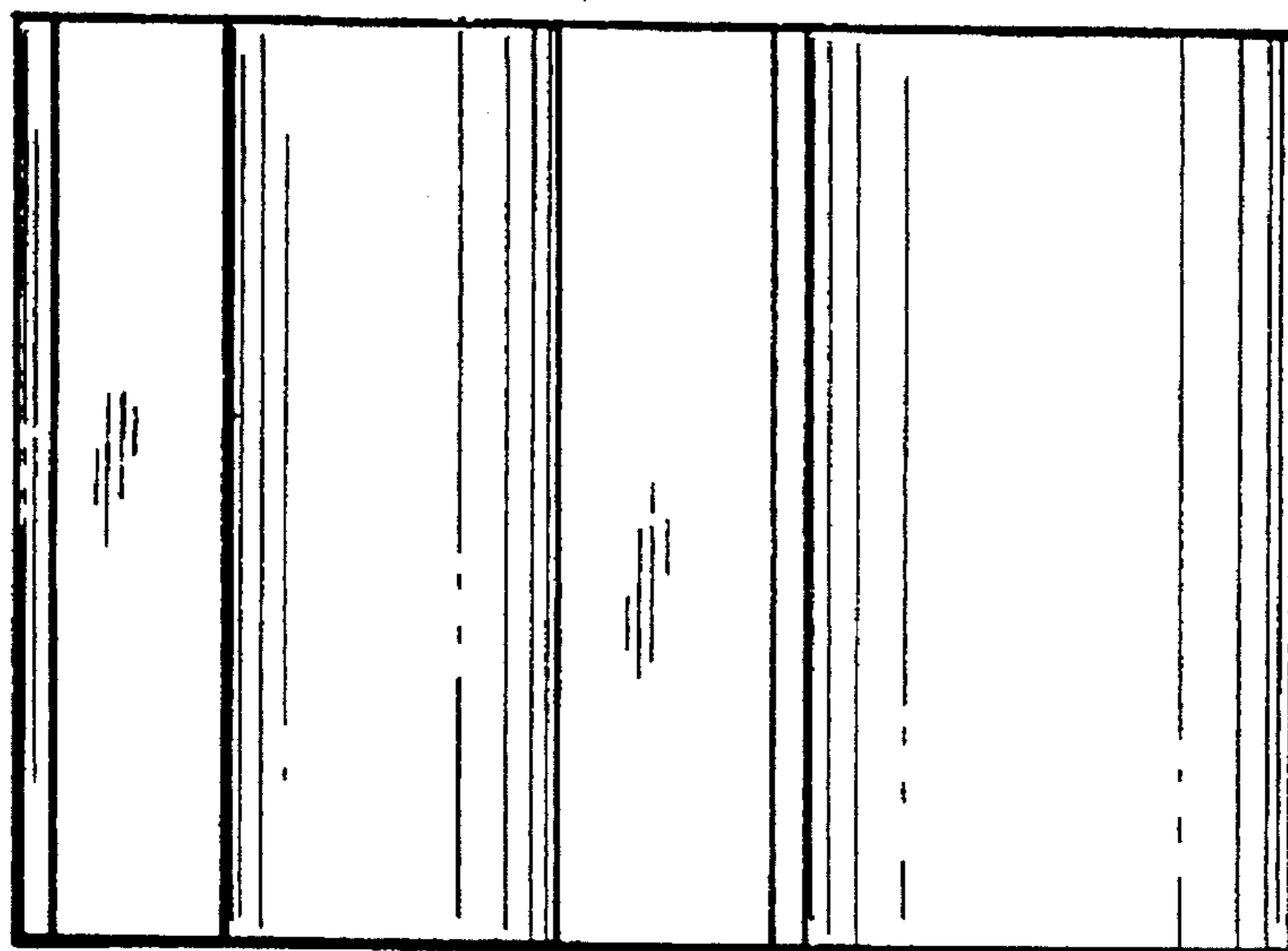

FIG. 4

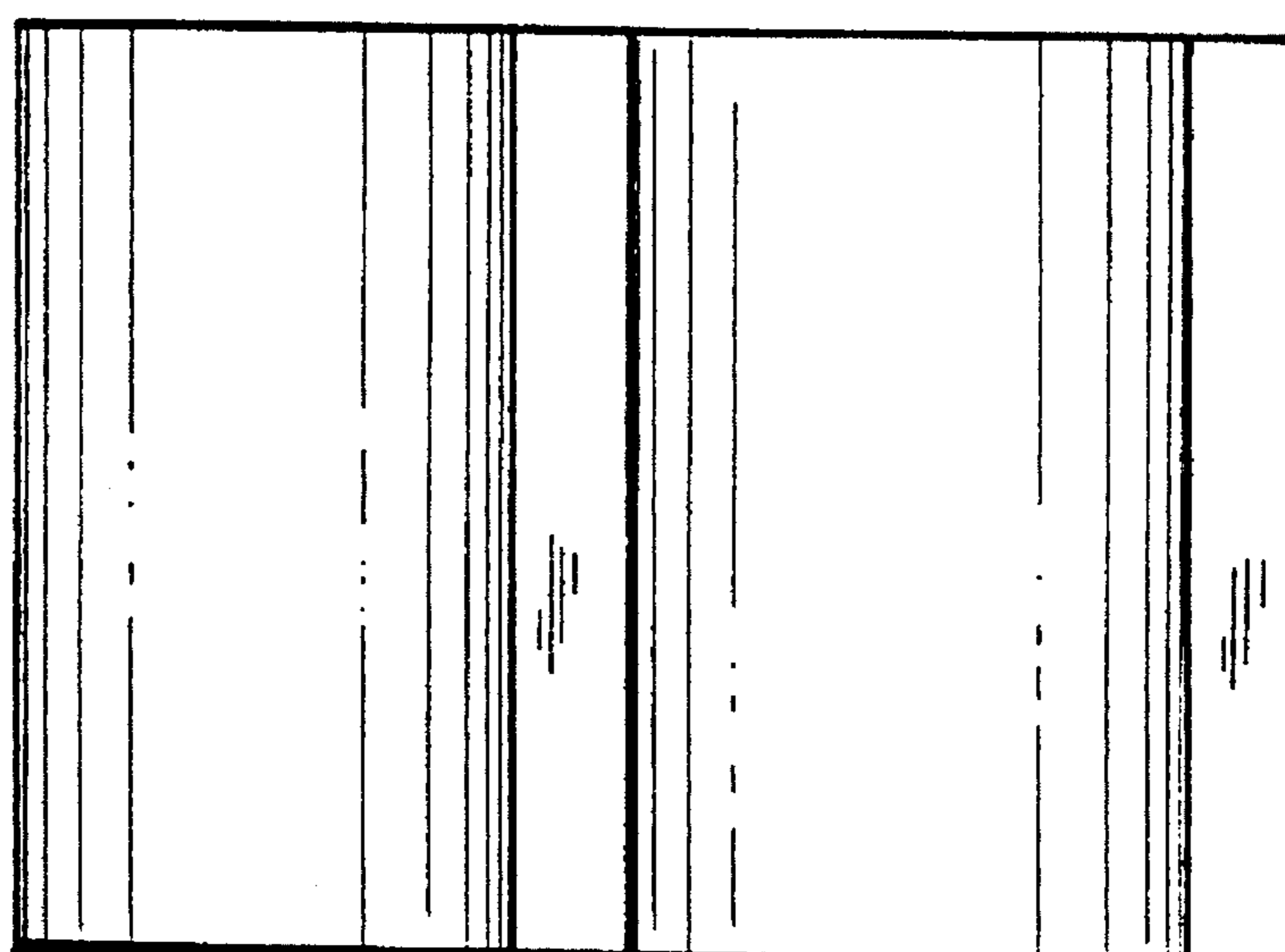

FIG. 5

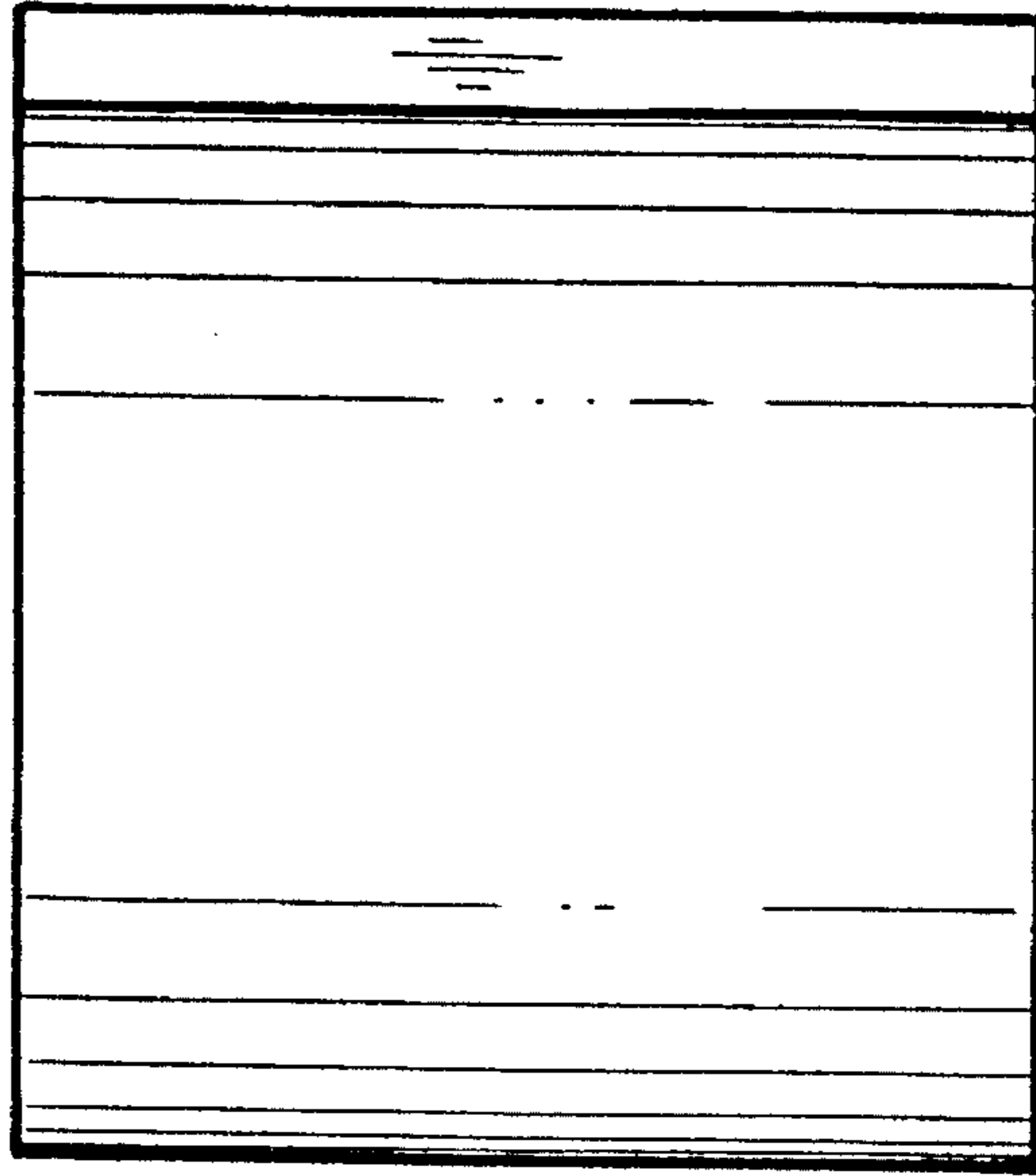

FIG. 6

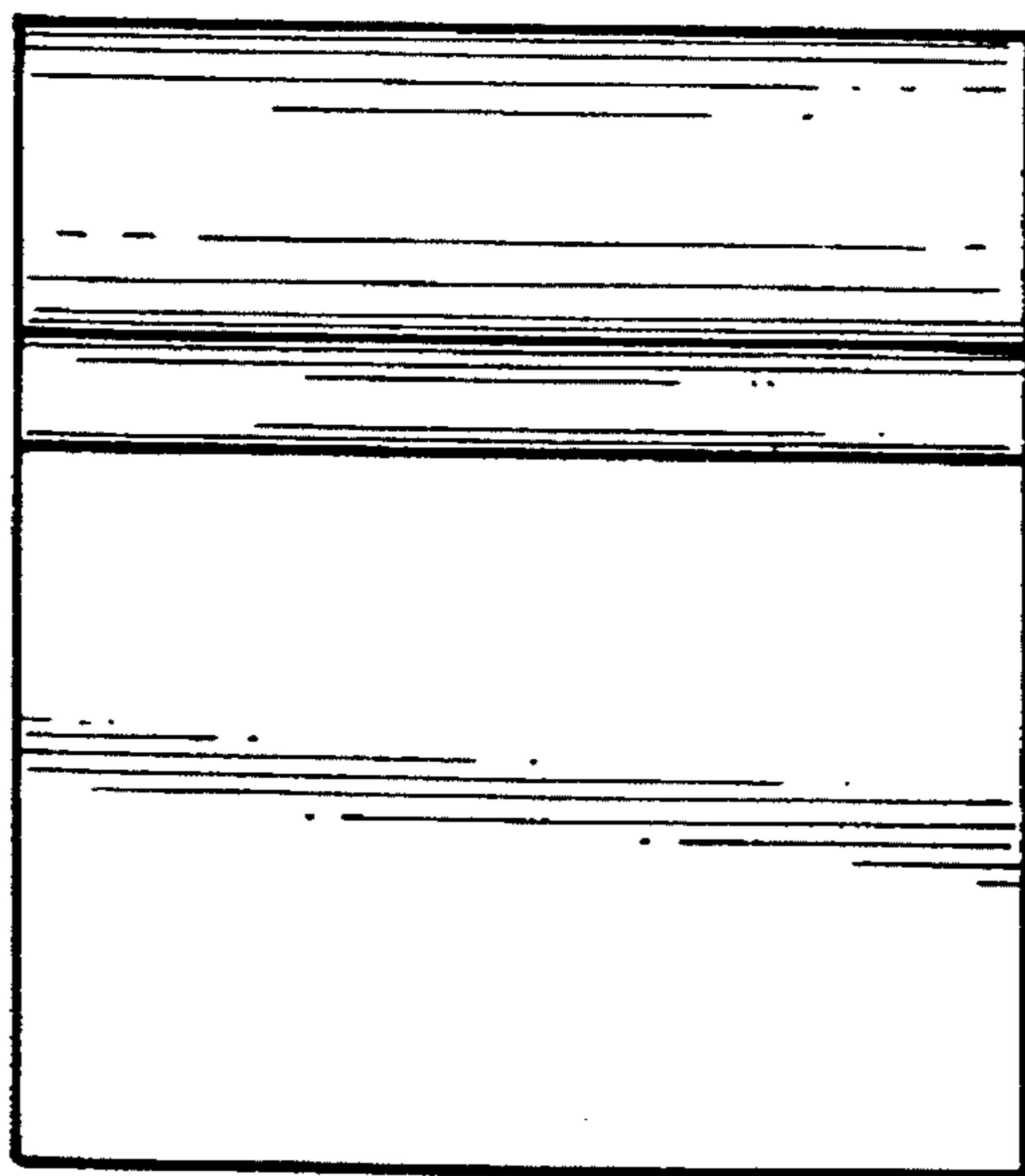

FIG. 7

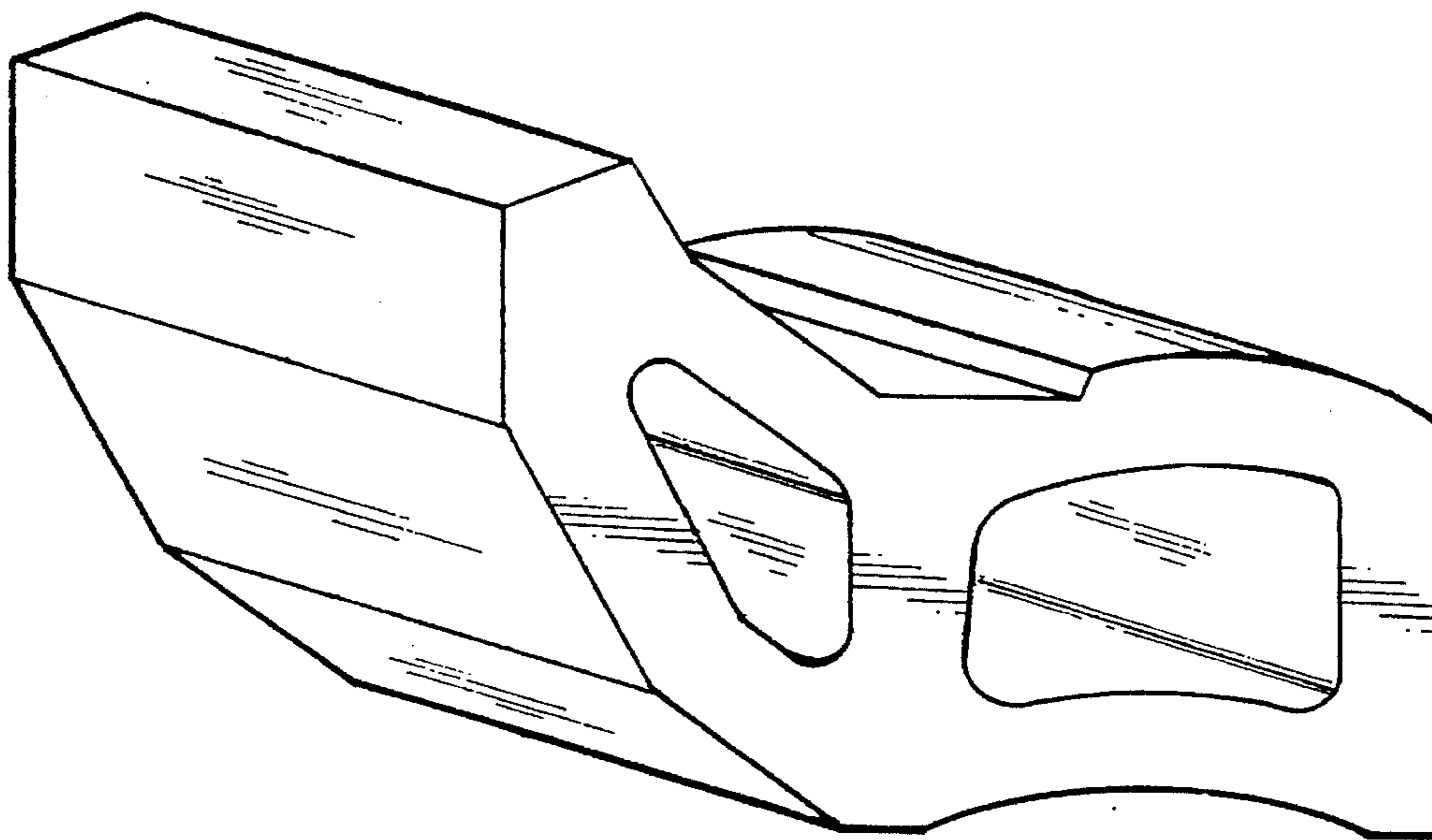

FIG. 8

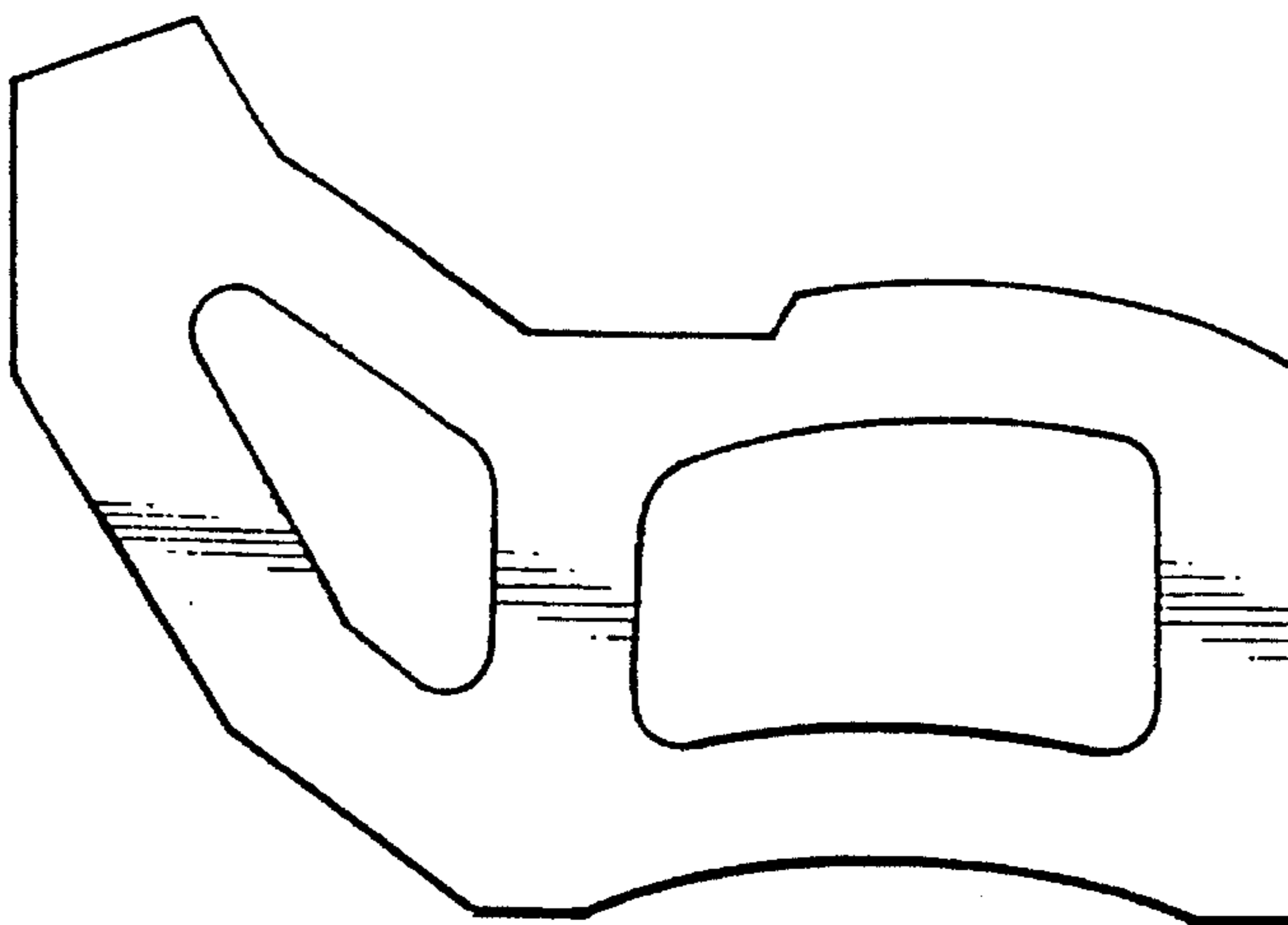

FIG. 9

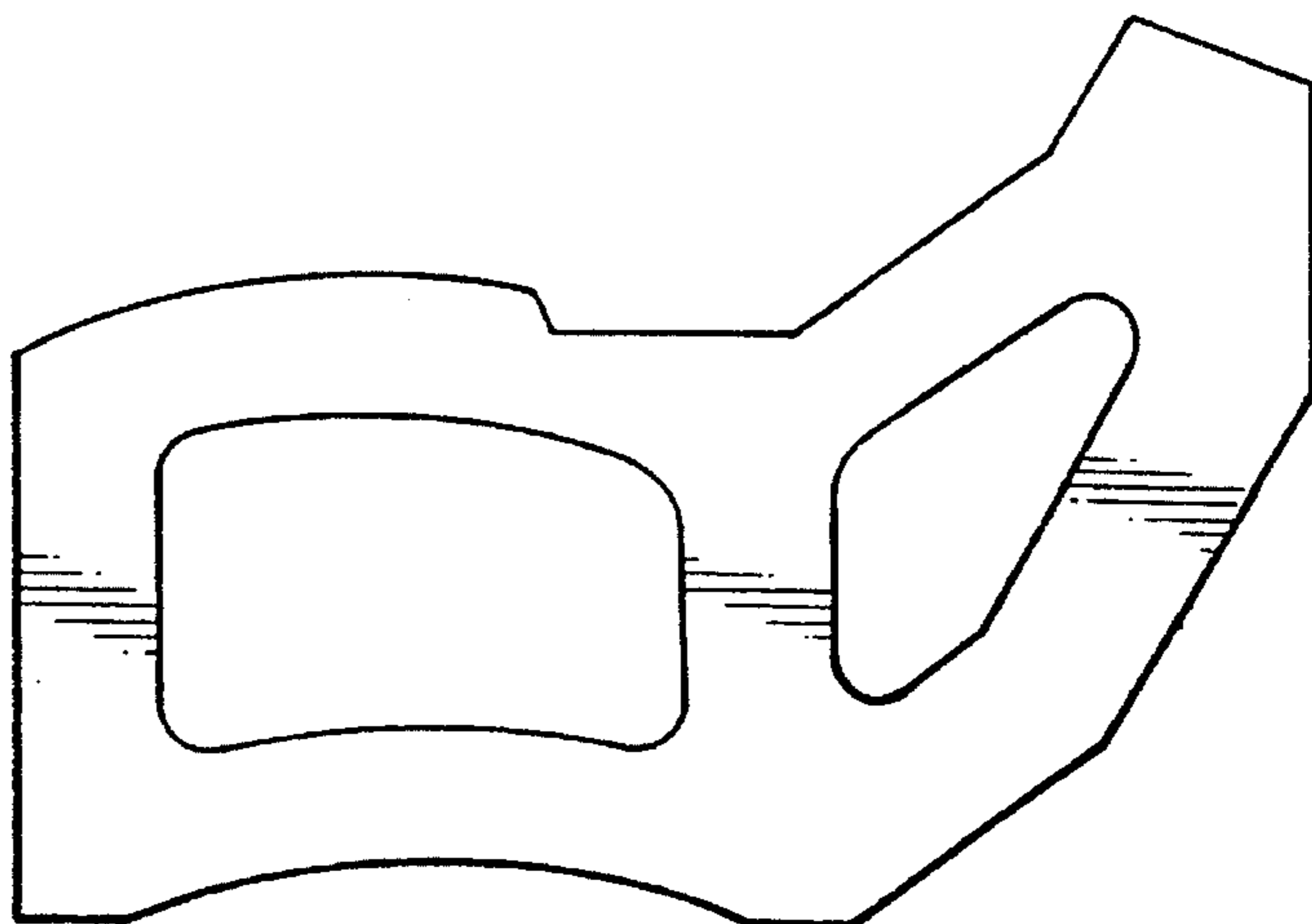

FIG. 10

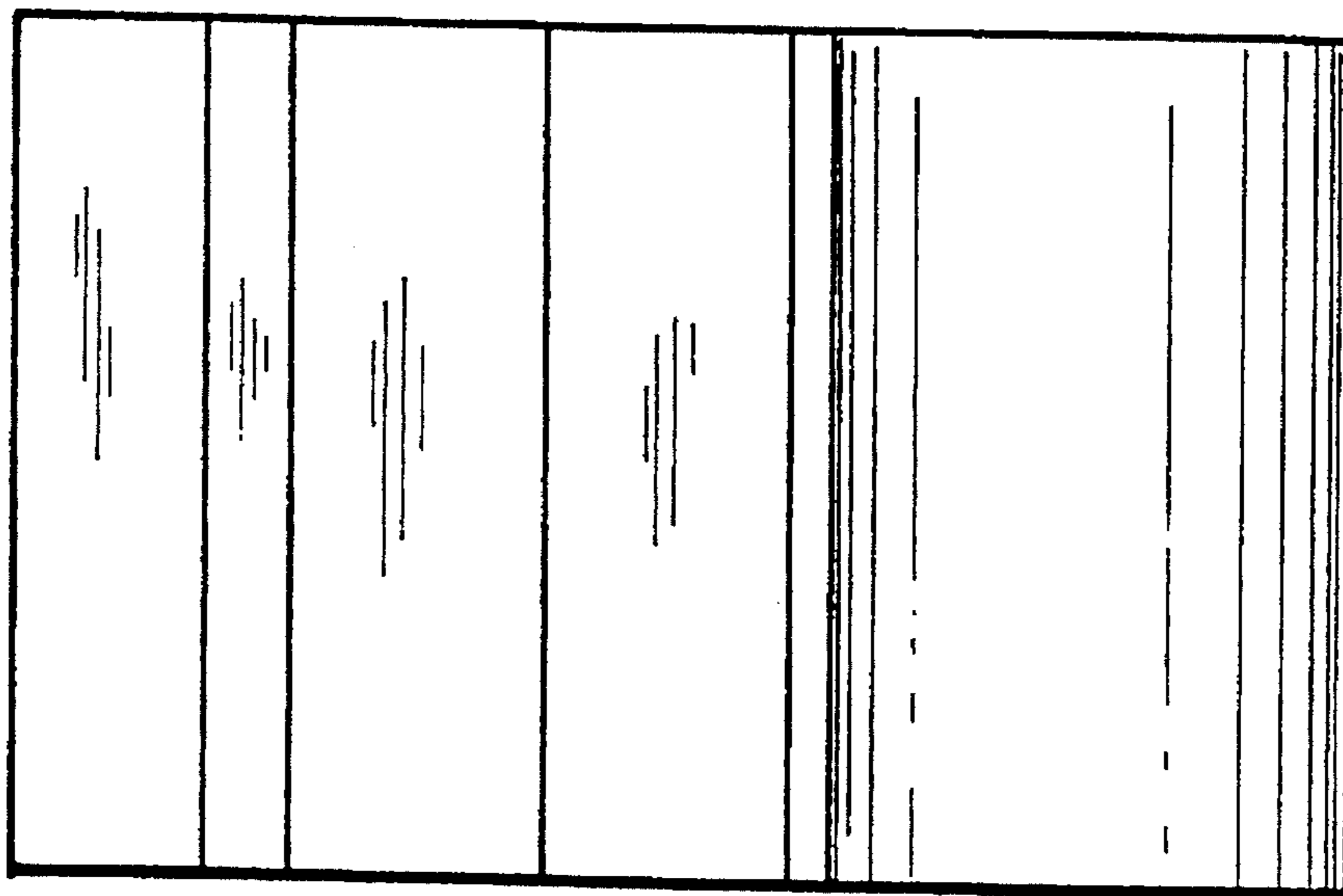

FIG. 11

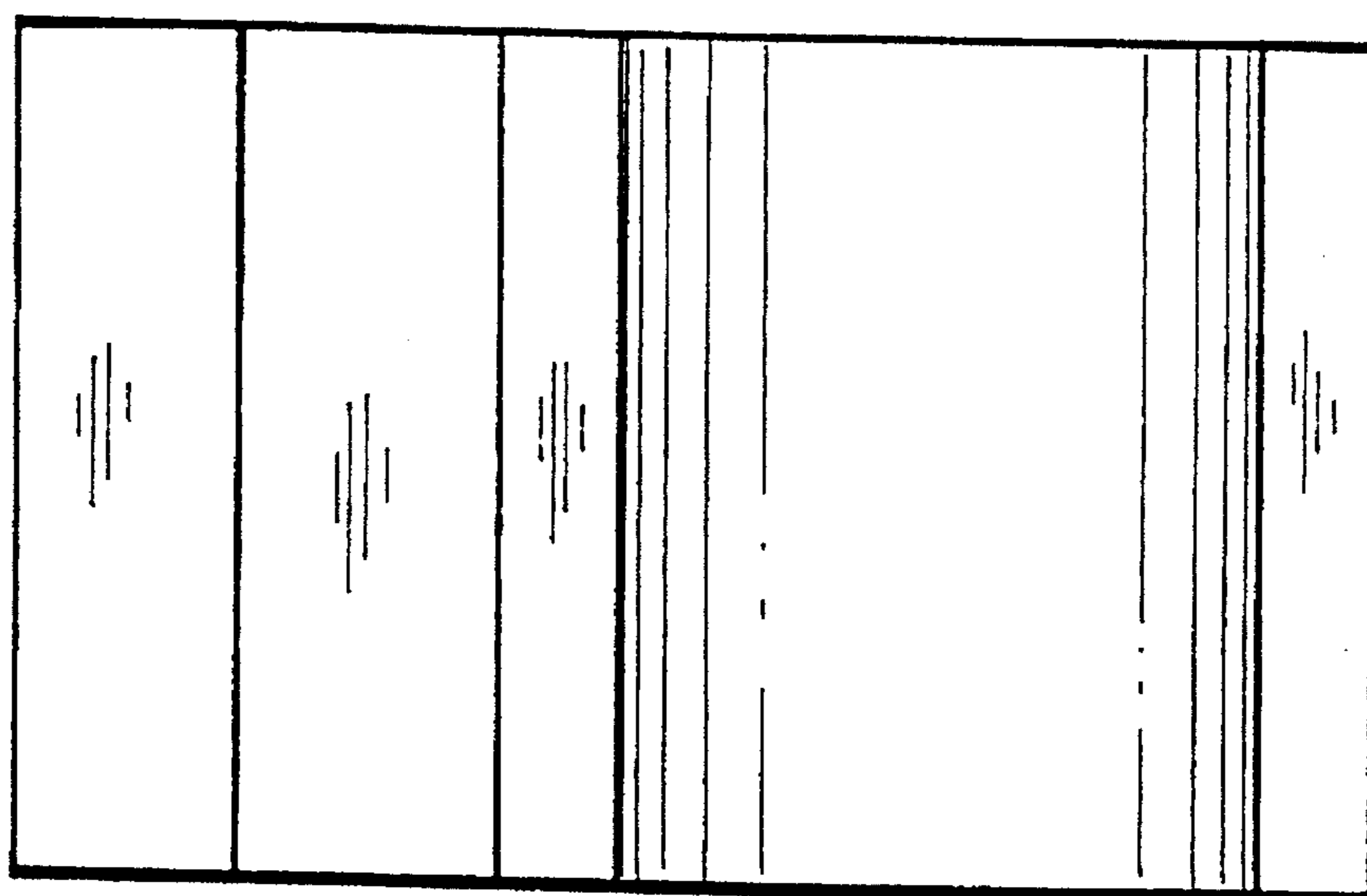

FIG. 12

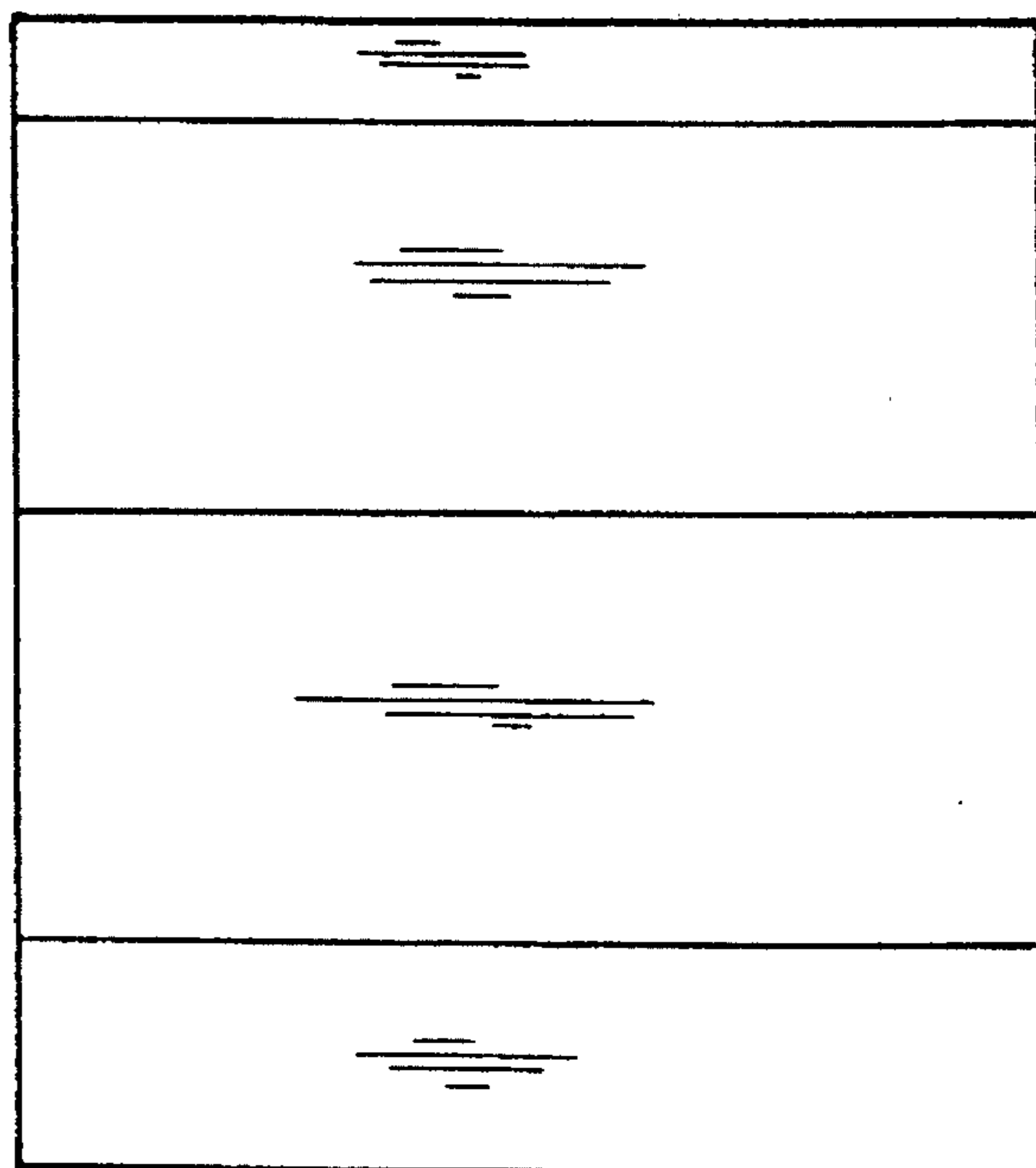

FIG. 13

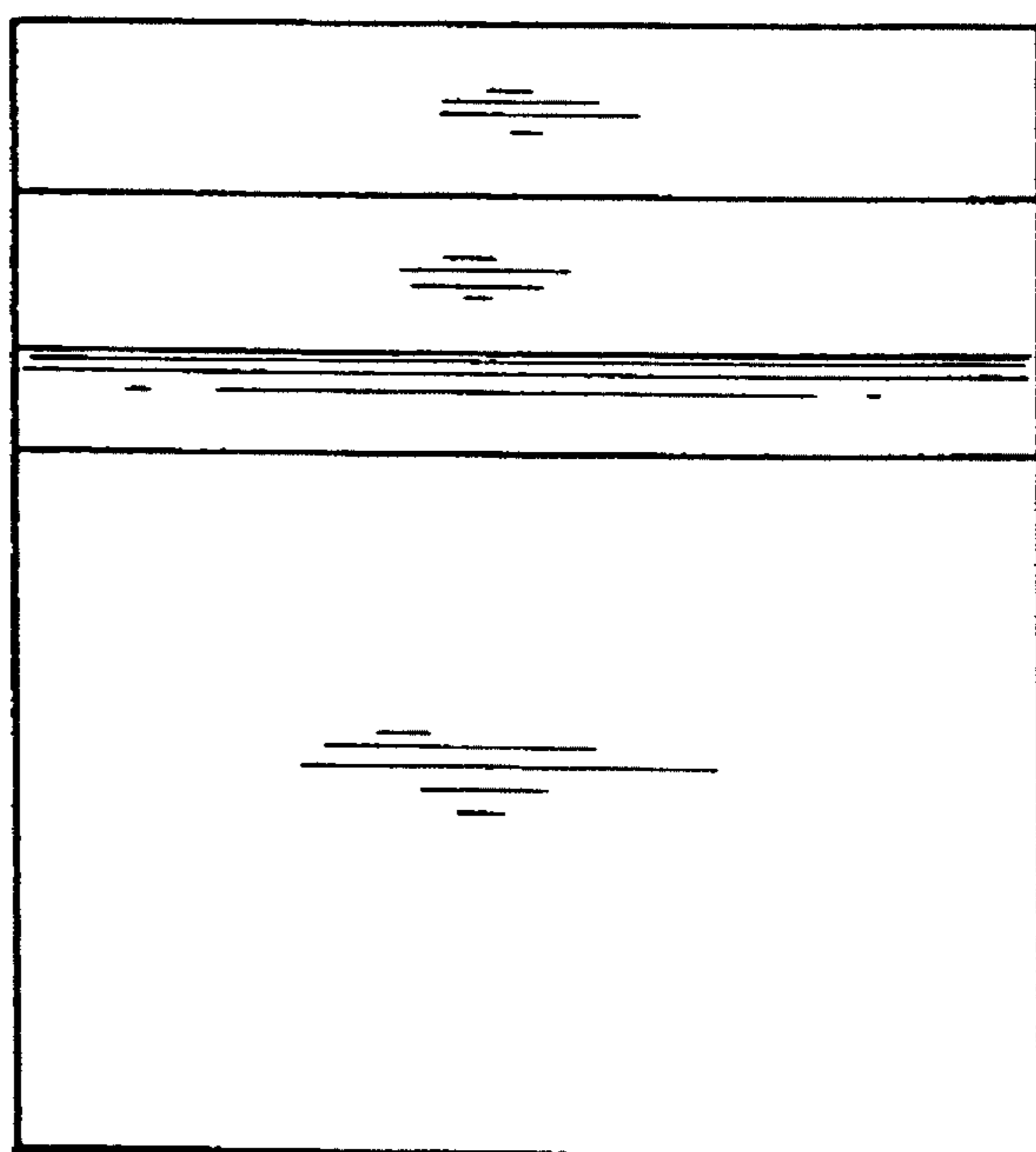

FIG. 14

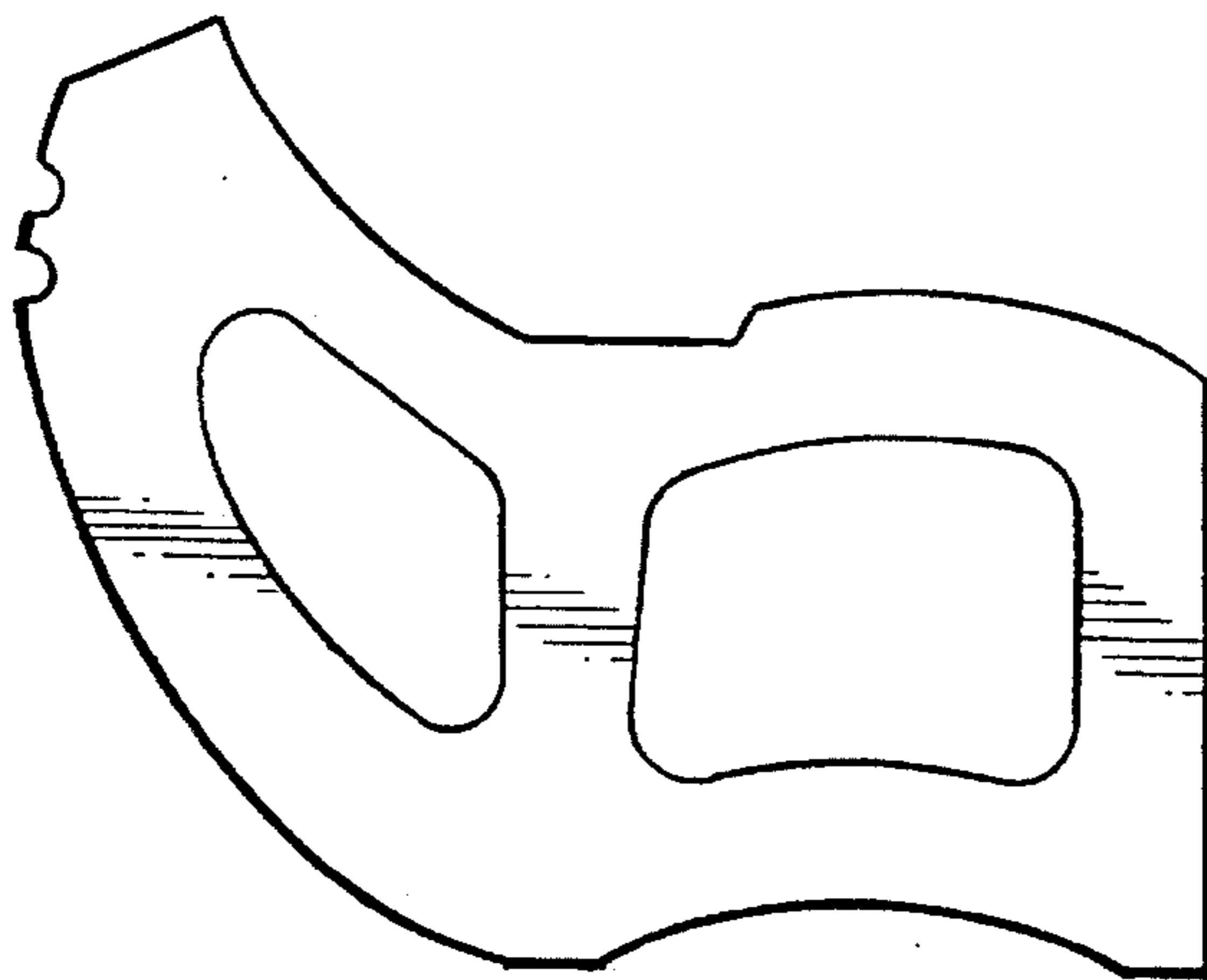

FIG. 15

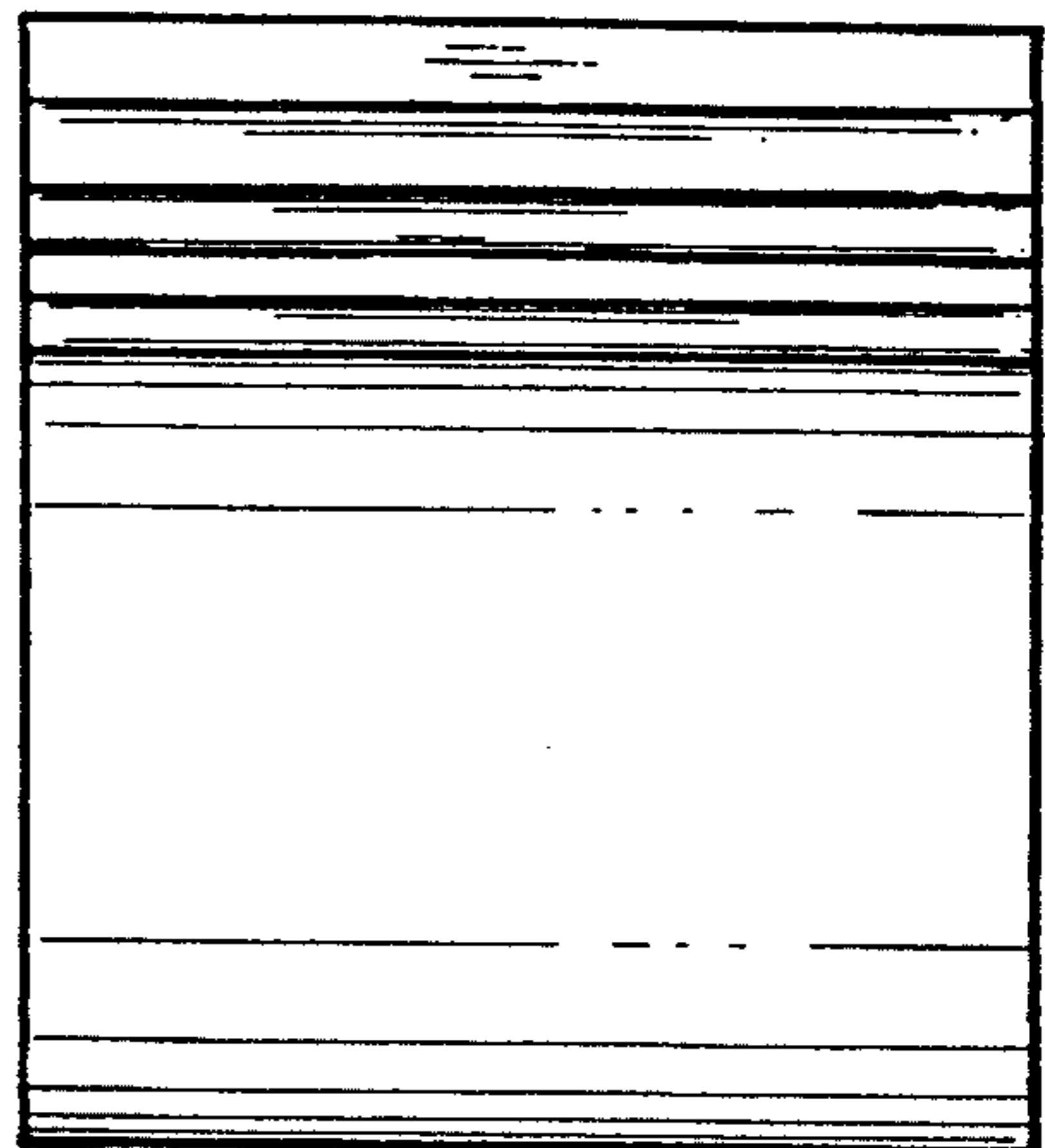

FIG. 16

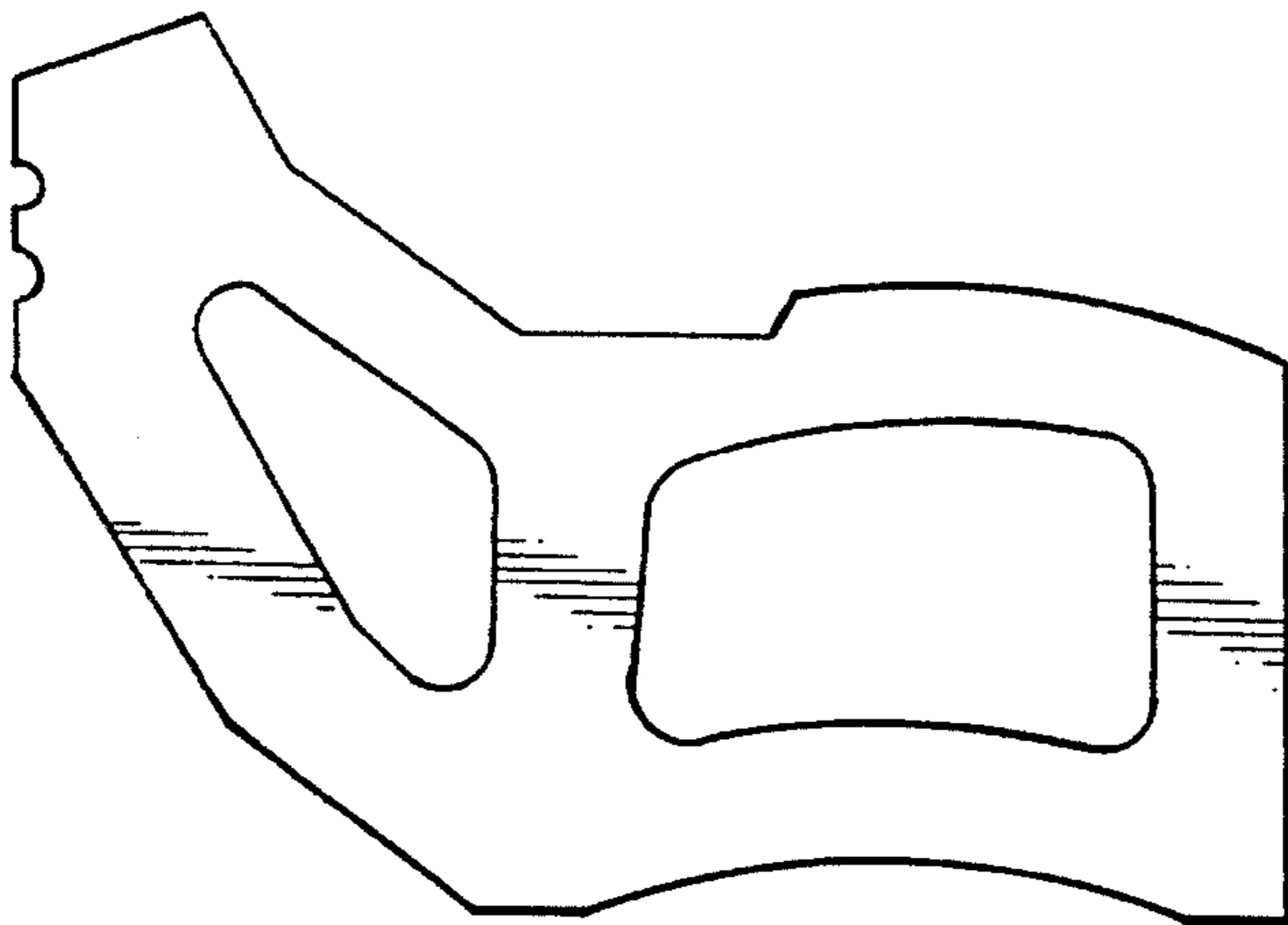

FIG. 17

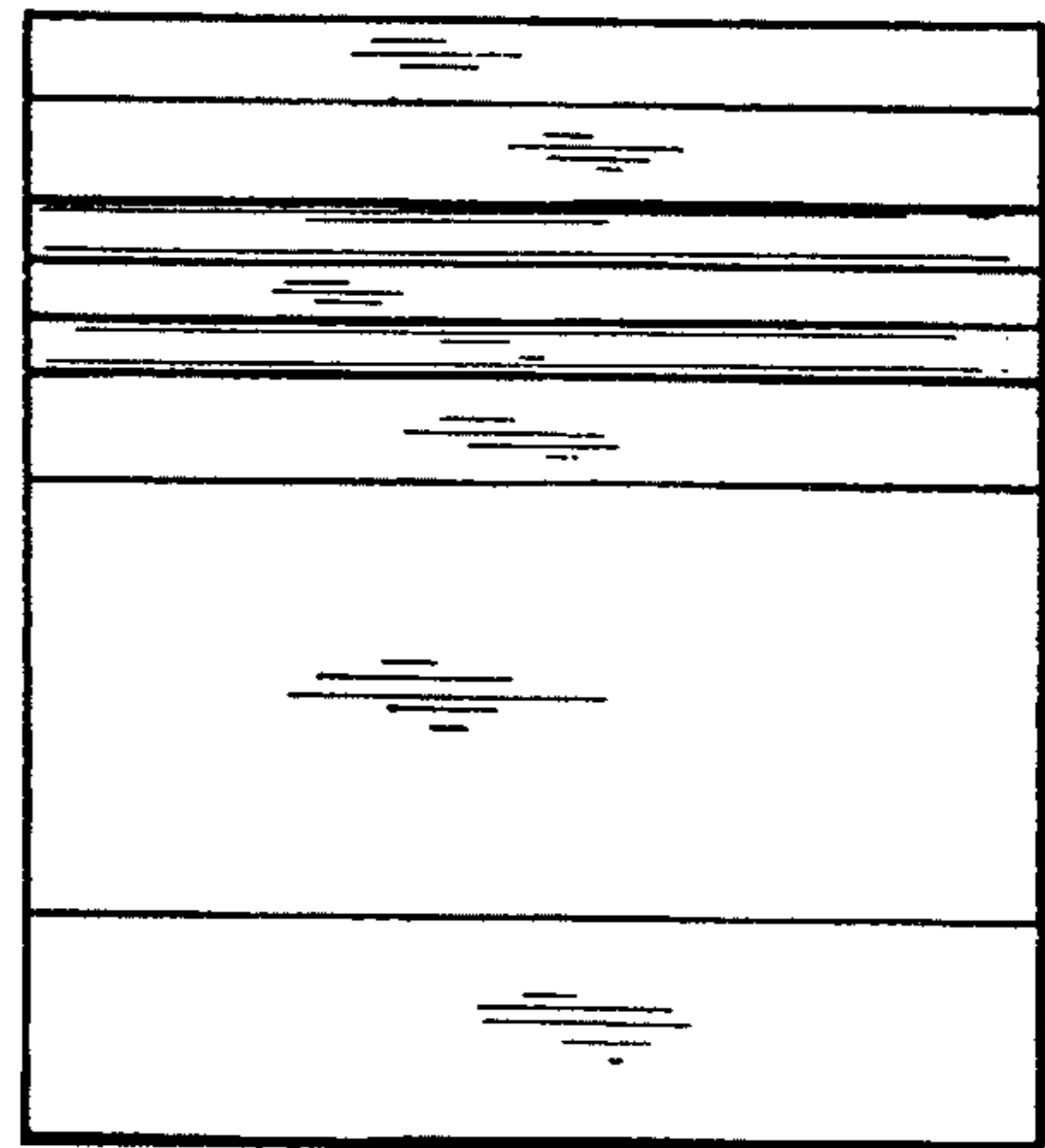

FIG. 18

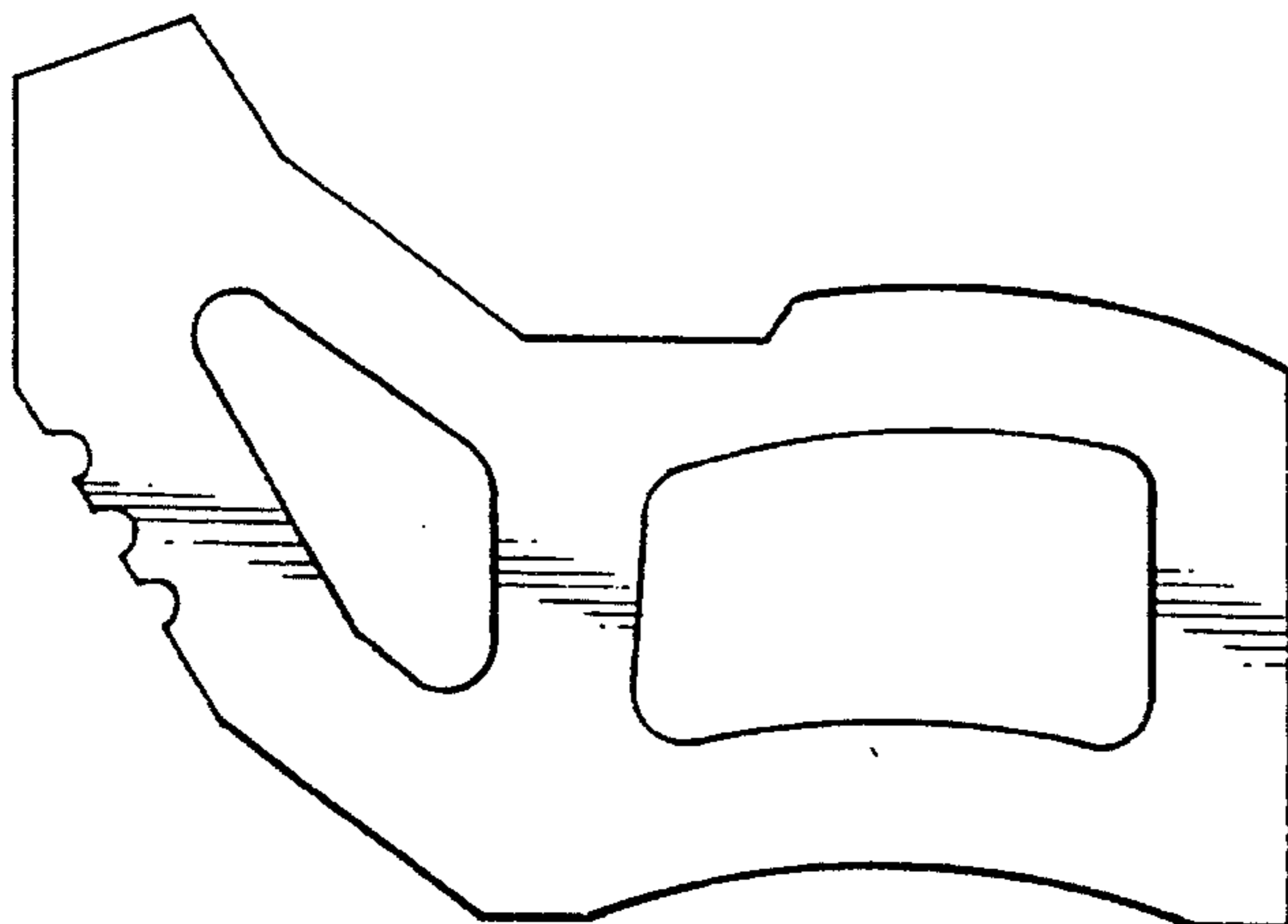

FIG. 19

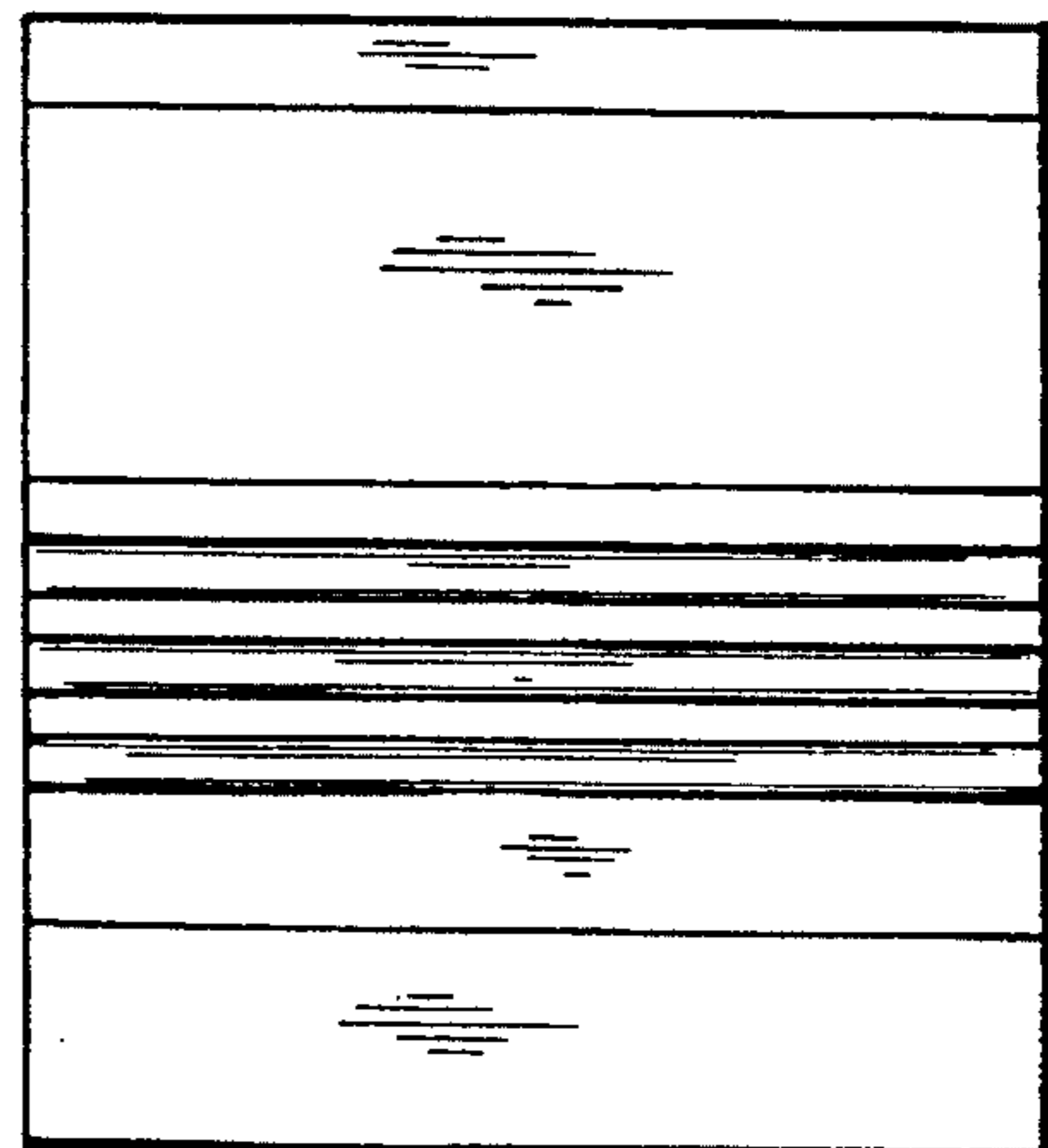

FIG. 20