



US00D367711S

United States Patent [19]

[11] Patent Number: **Des. 367,711**

Simmons

[45] Date of Patent: ****Mar. 5, 1996**

[54] **COMBINED HOT AND COLD PACK VEST AND HARNESS**

5,206,957 5/1993 Gulick 2/84
5,230,335 11/1993 Johnson, Jr. et al. 128/400

[76] Inventor: **William J. Simmons**, 535 Peach Orchard Pl., Aiken, S.C. 29801

Primary Examiner—Stella Reid
Attorney, Agent, or Firm—David L. Baker; Rhodes & Ascolillo

[**] Term: **14 Years**

[57] CLAIM

[21] Appl. No.: **26,029**

The ornamental design for a combined hot and cold pack vest and harness, as shown and described.

[22] Filed: **Jul. 18, 1994**

[52] U.S. Cl. **D24/206**

DESCRIPTION

[58] **Field of Search** D24/206, 200, D24/190; 607/104, 108, 96; 602/2, 20; 2/2, 44, 92, 84, 69, 73, 75, 77, 102, 108, 111, 113-115, 901

FIG. 1 is a perspective view of a combined hot and cold pack vest and harness showing my new design therefor; FIG. 2 is a front elevational view; FIG. 3 is a rear elevational view; FIG. 4 is a top plan view; FIG. 5 is a right side elevational view; FIG. 6 is a left side elevational view; and, FIG. 7 is a bottom plan view.

[56] References Cited

U.S. PATENT DOCUMENTS

4,261,059 4/1981 Spitz 2/108
4,472,835 9/1984 Clark 2/102
4,738,119 4/1988 Zafred D24/206 X

1 Claim, 3 Drawing Sheets

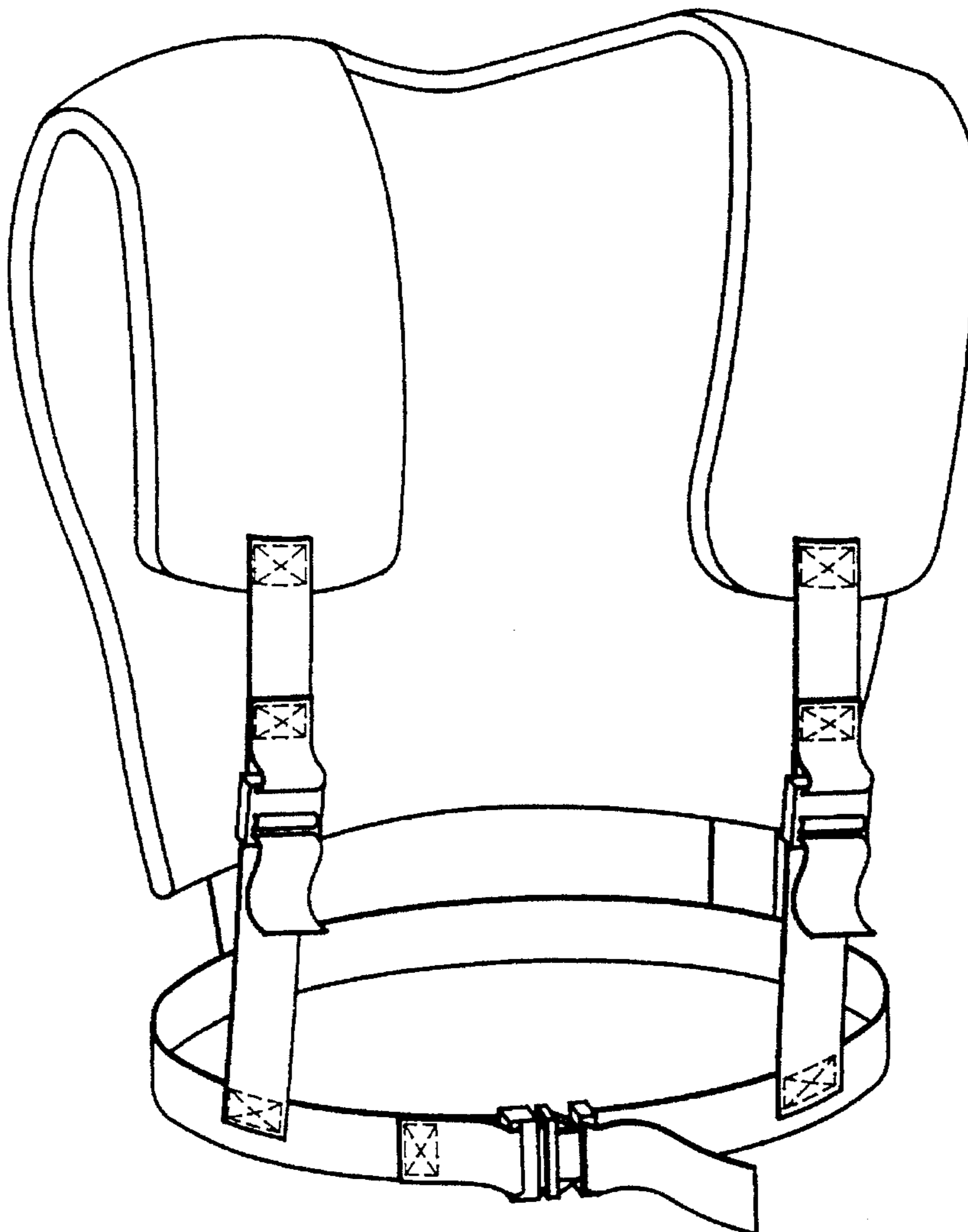

FIG. 1

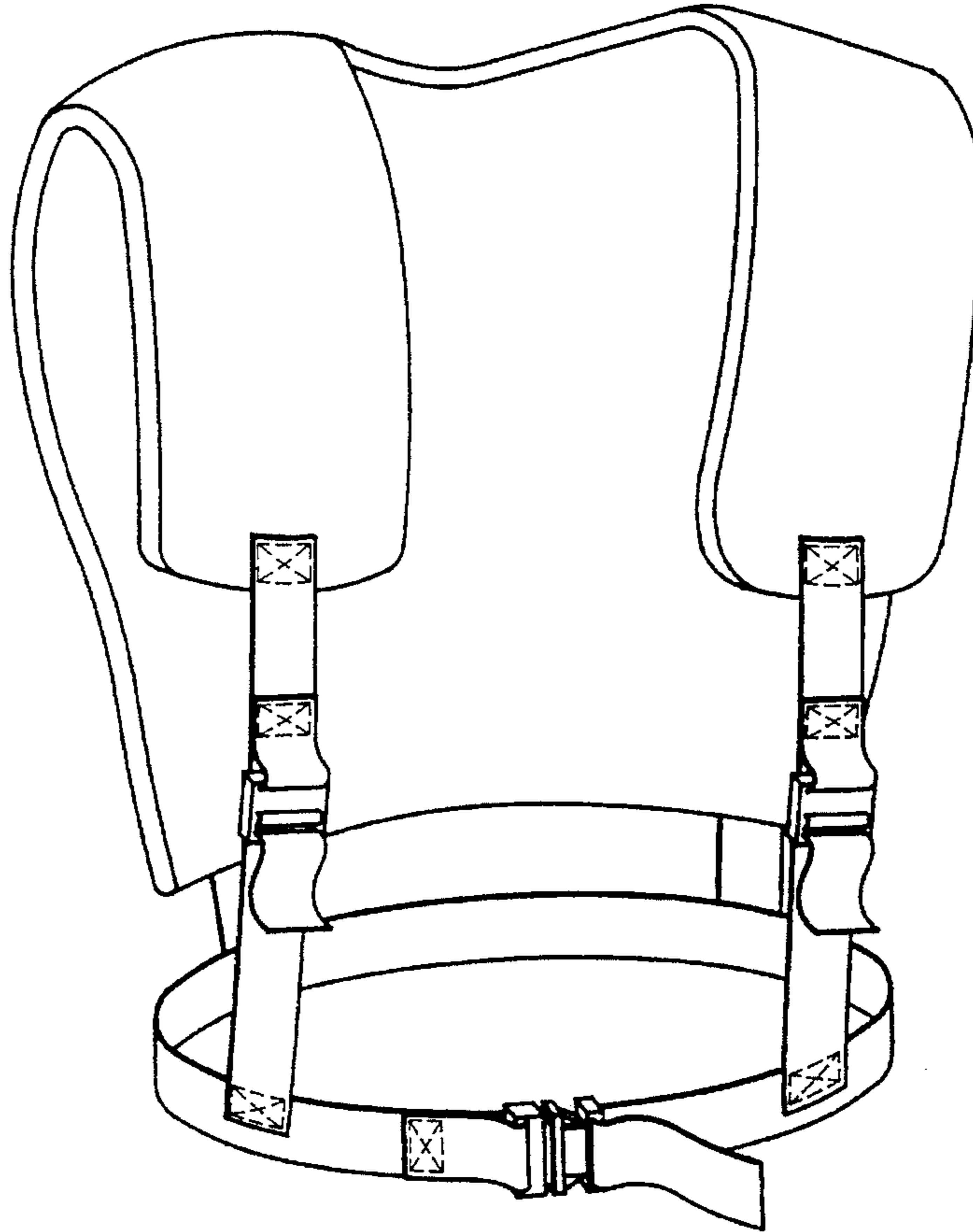

FIG. 7

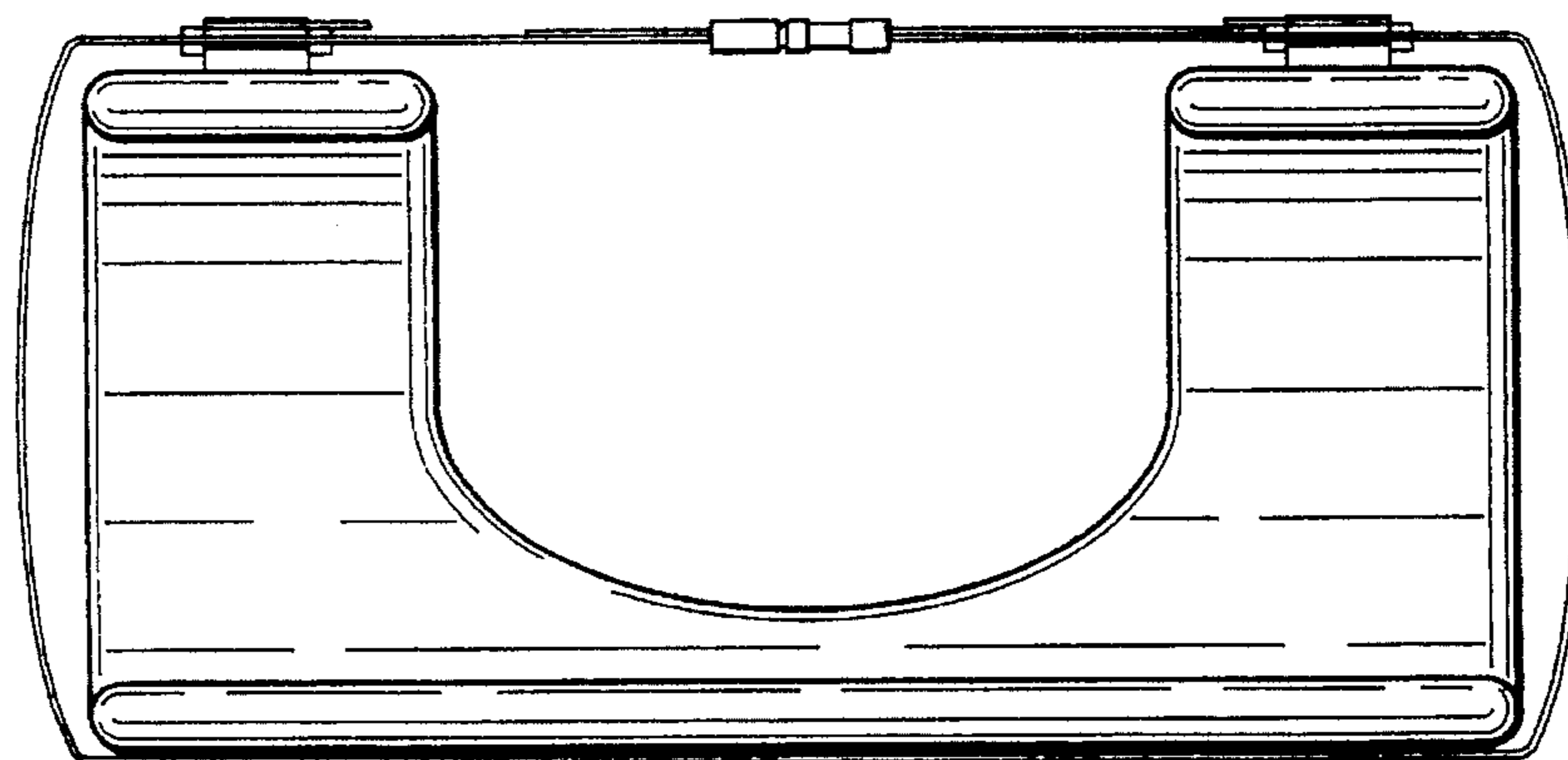

FIG. 3

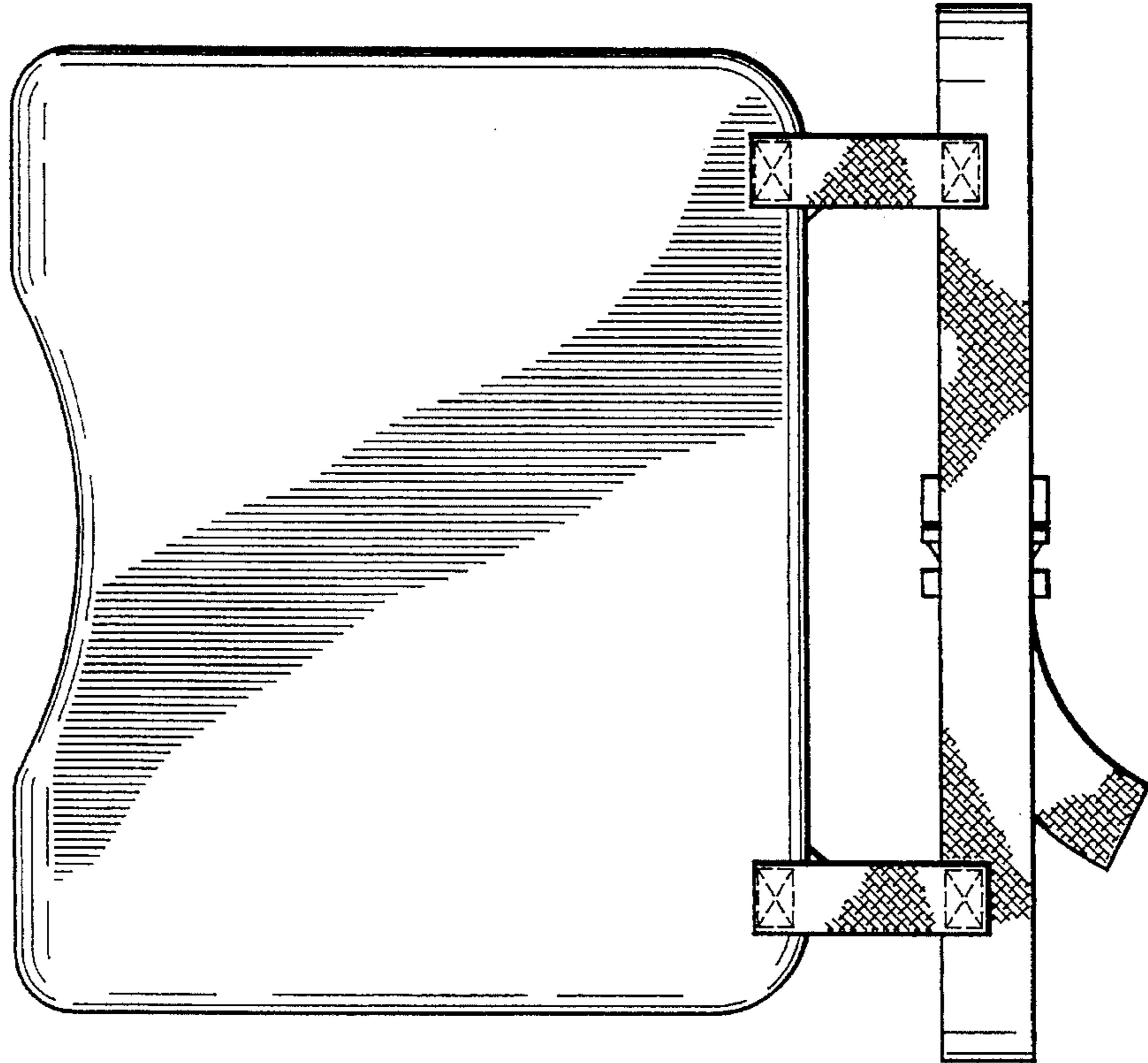

FIG. 2

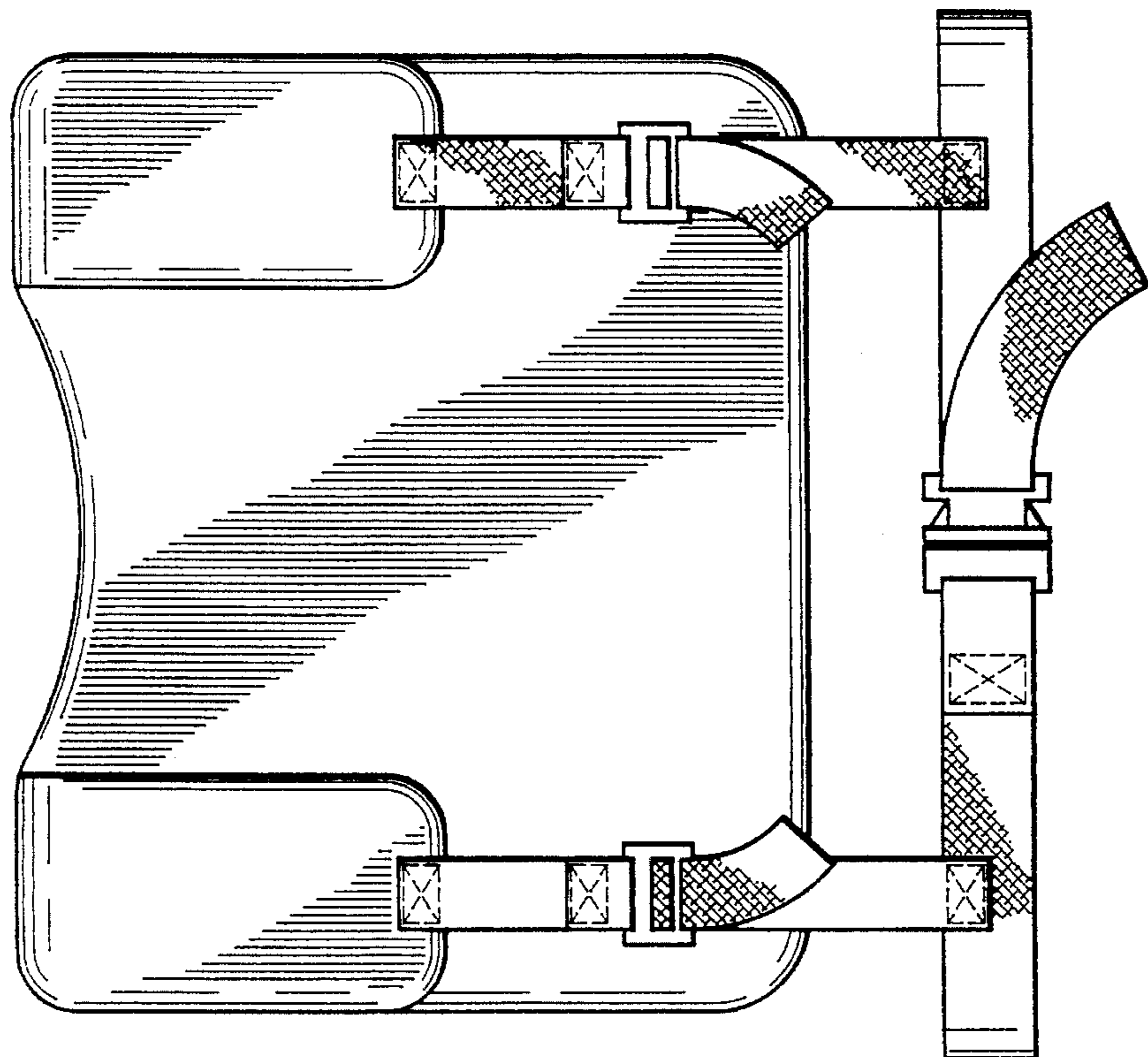

FIG. 5

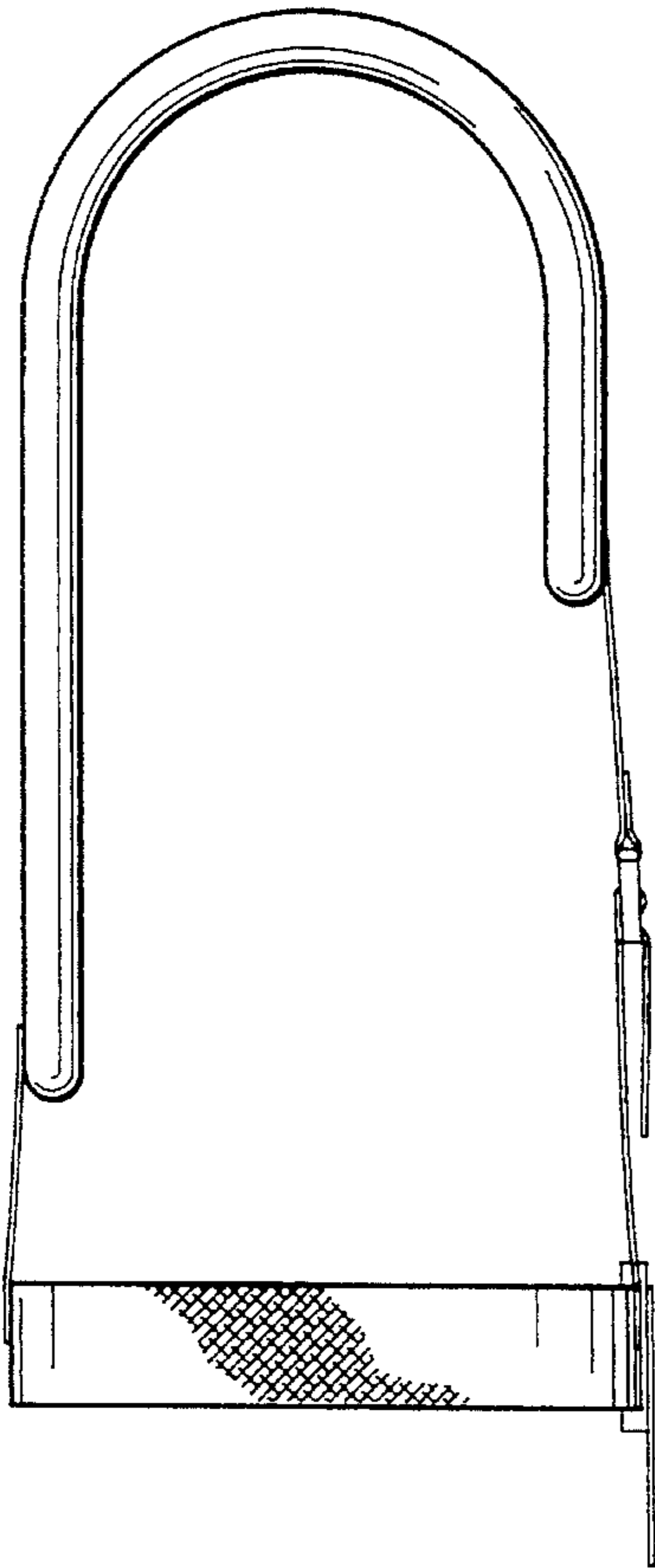

FIG. 6

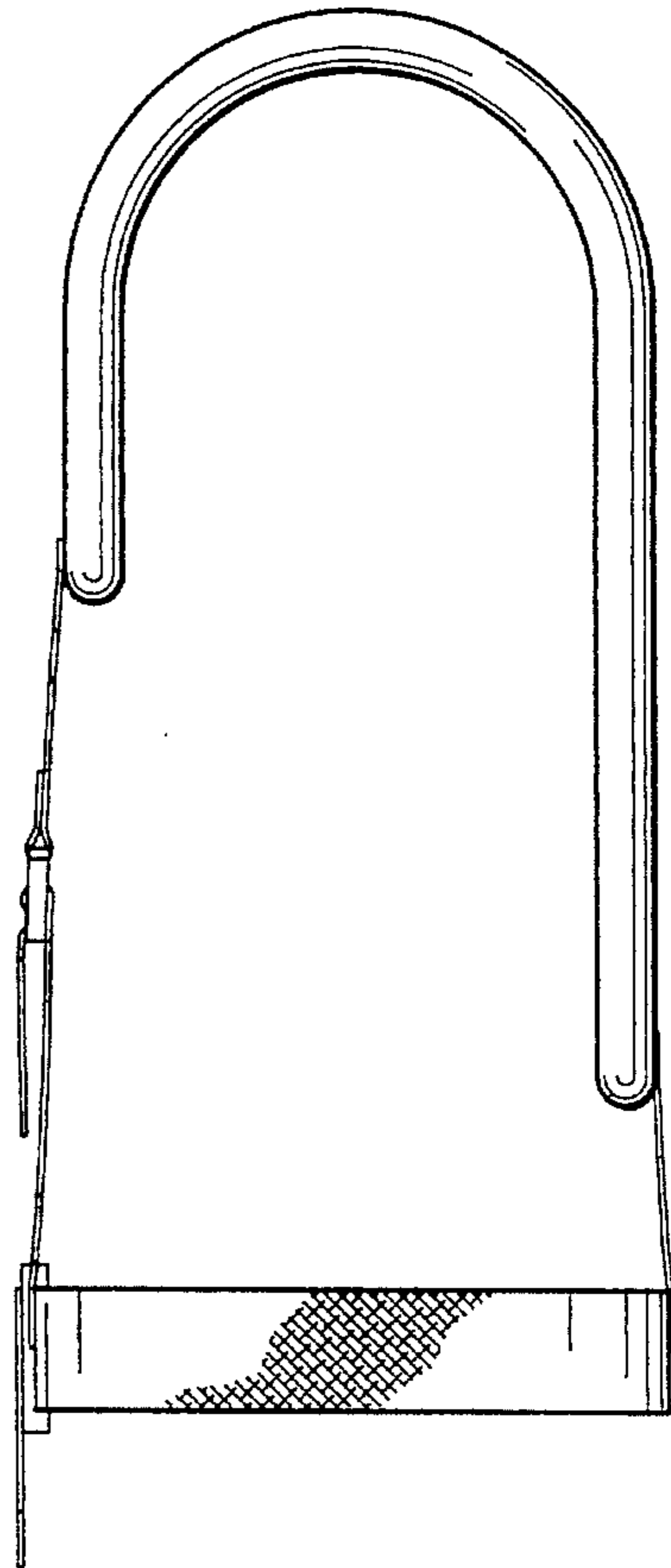

FIG. 4

