



US00D367653S

# United States Patent [19]

Tajima

[11] Patent Number: **Des. 367,653**

[45] Date of Patent: **\*\*Mar. 5, 1996**

[54] **MESSAGE DECODER**

[75] Inventor: **Kazuaki Tajima**, Yokohama, Japan

[73] Assignee: **Oi Electric Co., Ltd.**, Kanagawa, Japan

[\*\*] Term: **14 Years**

[21] Appl. No.: **31,876**

[22] Filed: **Dec. 8, 1994**

[30] **Foreign Application Priority Data**

Jun. 8, 1994 [JP] Japan ..... 6-16963

[52] U.S. Cl. .... **D14/191**

[58] Field of Search ..... D8/347; D14/124,  
D14/188, 191, 192, 299; 340/311.1; 455/38.1-38.4,  
90, 92, 100, 128, 344

[56] **References Cited**

**U.S. PATENT DOCUMENTS**

D. 321,690 11/1991 Brenda et al. .... D14/191  
D. 321,691 11/1991 Brenda et al. .... D14/191  
D. 345,980 4/1994 Sheid et al. .... D14/191

**FOREIGN PATENT DOCUMENTS**

46834 2/1991 Japan ..... 455/38.4

*Primary Examiner*—Ted Shooman  
*Assistant Examiner*—Nanda Bondade  
*Attorney, Agent, or Firm*—Loeb and Loeb

[57] **CLAIM**

The ornamental design for a message decoder, as shown and described.

**DESCRIPTION**

FIG. 1 is a front elevational view of a message decoder showing my new design;  
FIG. 2 is a left side elevational view thereof;  
FIG. 3 is a right side elevational view thereof;  
FIG. 4 is a top plan view thereof;  
FIG. 5 is a bottom plan view thereof;  
FIG. 6 is a rear elevational view thereof;  
FIG. 7 is a cross-sectional view along line A—A of FIG. 1, with internal components removed;  
FIG. 8 is a cross-sectional view along line B—B of FIG. 1, with the internal components removed;  
FIG. 9 is a front elevational view of an alternate embodiment of FIG. 1;  
FIG. 10 is a left side elevational view of FIG. 9;  
FIG. 11 is a right side elevational view FIG. 9;  
FIG. 12 is a top plan view FIG. 9;  
FIG. 13 is a bottom plan view FIG. 9;  
FIG. 14 is a rear elevational view FIG. 9;  
FIG. 15 is a cross-sectional view along line A—A of FIG. 9, with internal components removed; and,  
FIG. 16 is a cross-sectional view along line B—B of FIG. 9, with internal components removed.

**1 Claim, 6 Drawing Sheets**

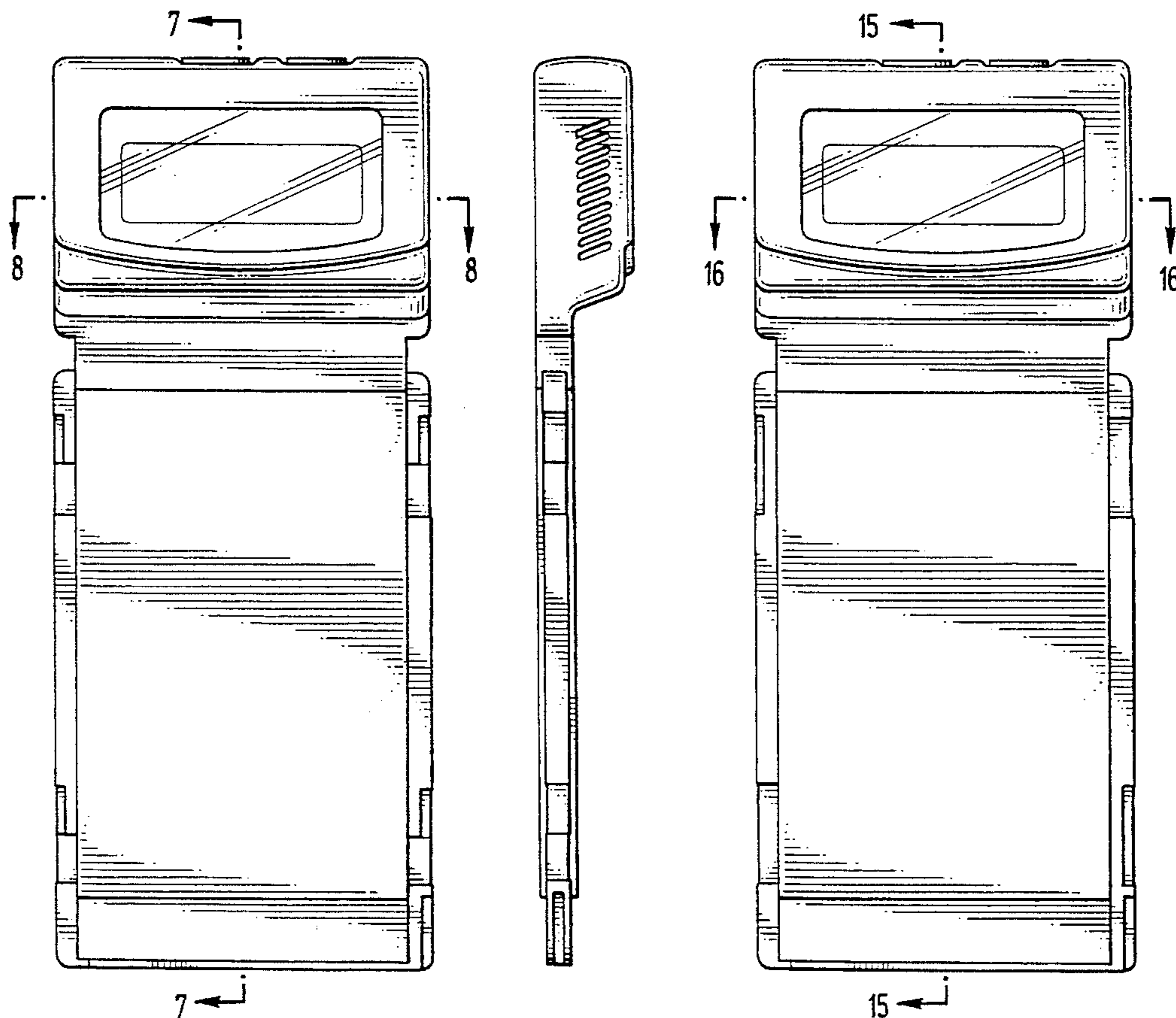

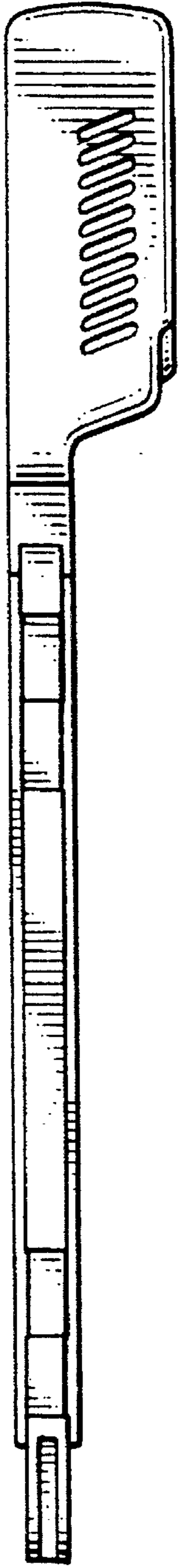

FIG. 2

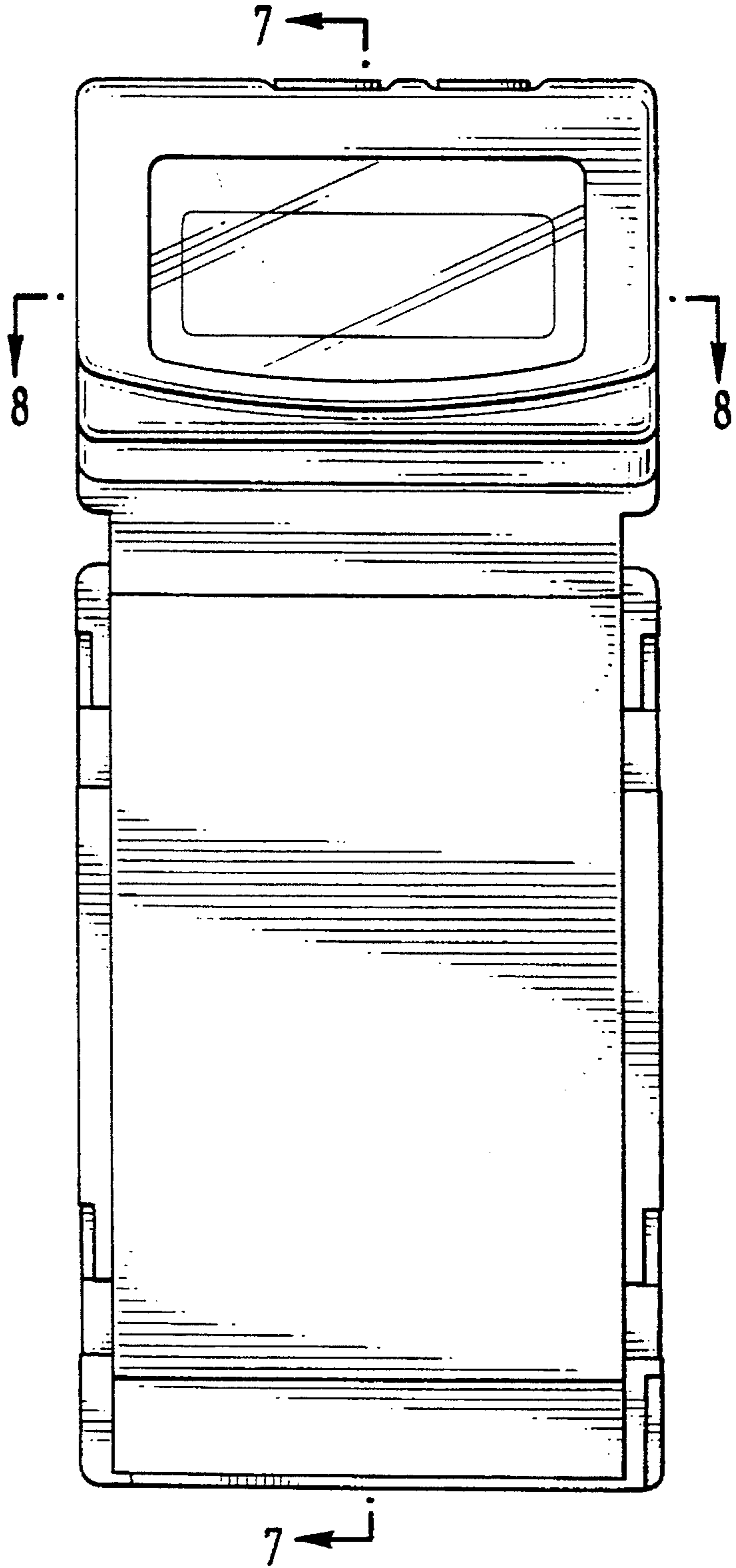

FIG. 1

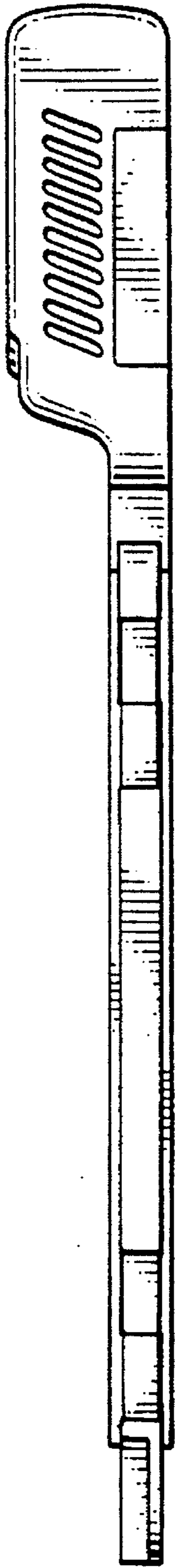

FIG. 3

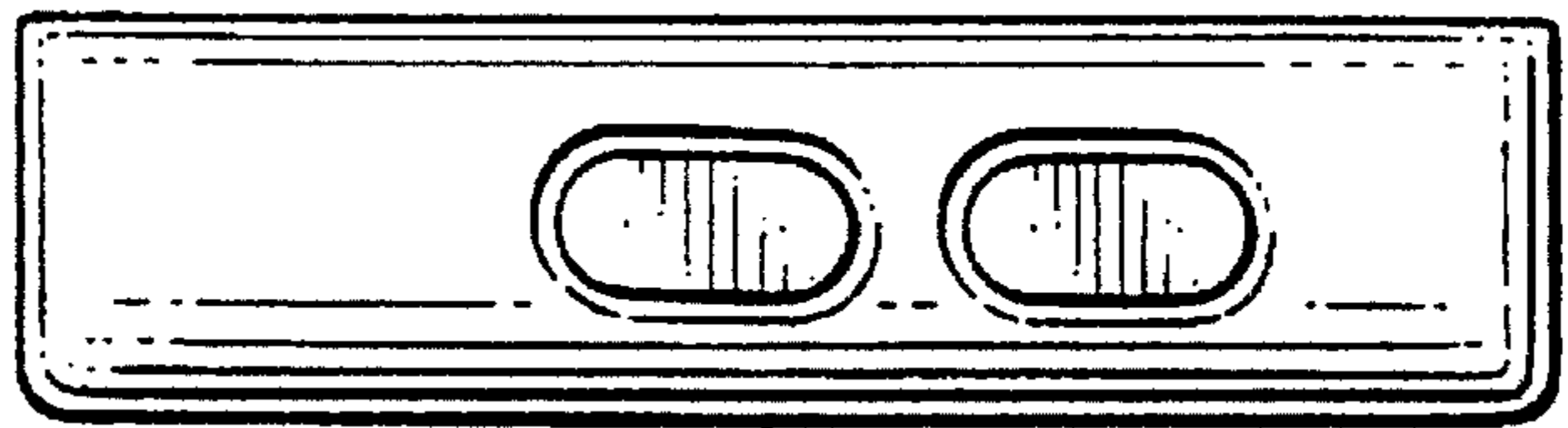

FIG. 4

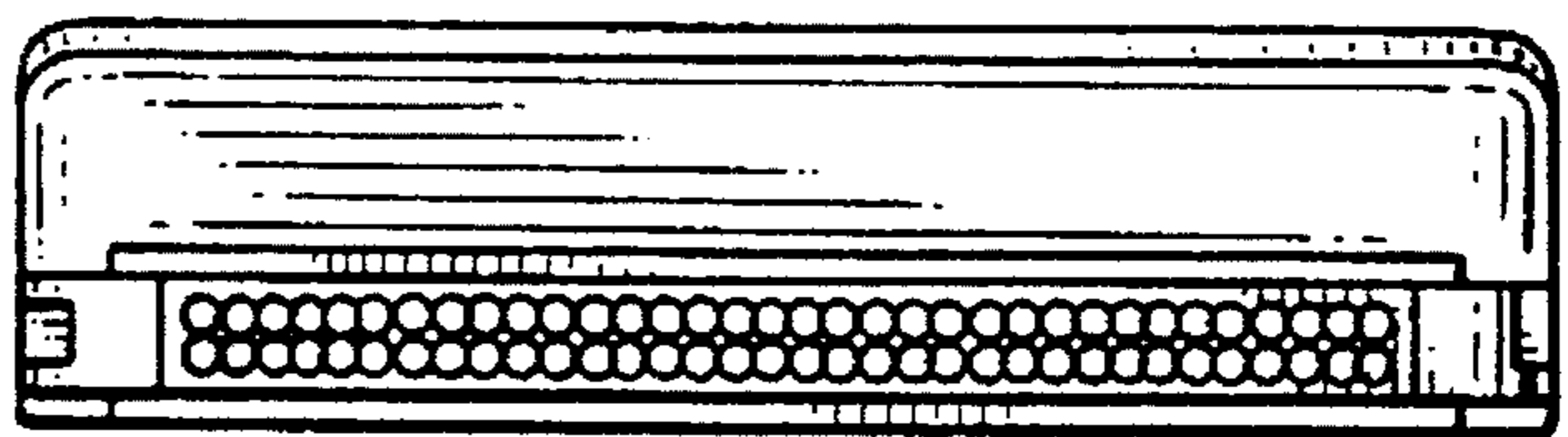

FIG. 5

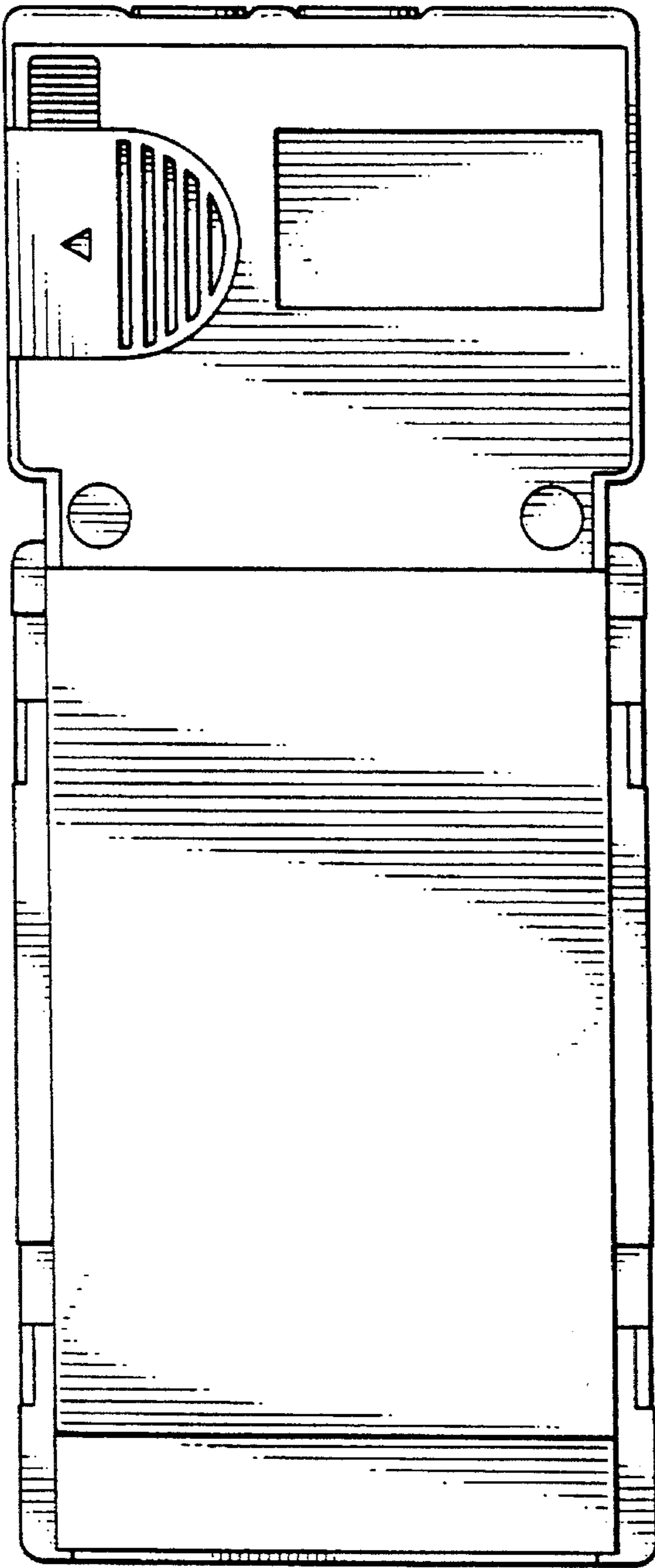

FIG. 6

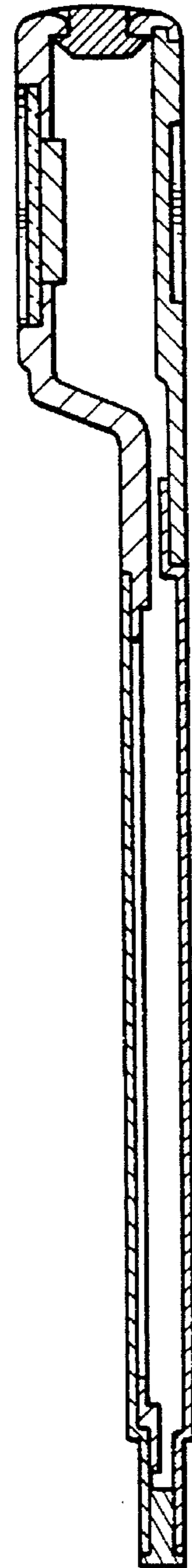

FIG. 7

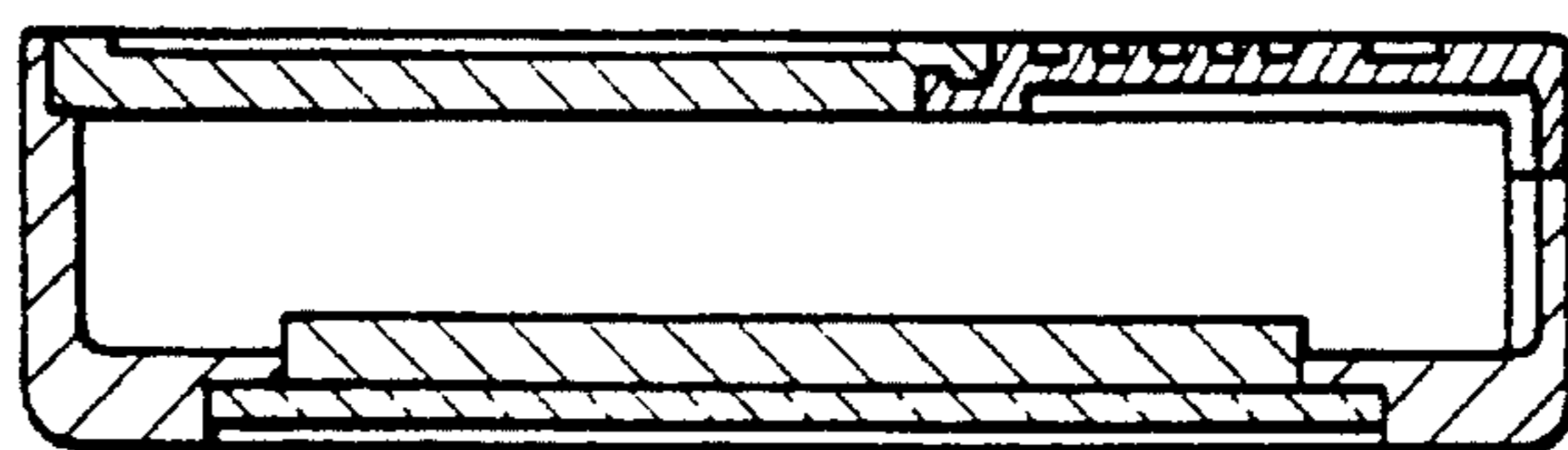

FIG. 8

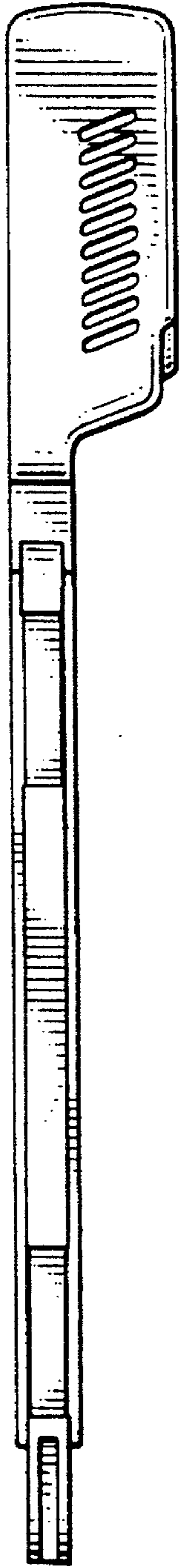

FIG. 10

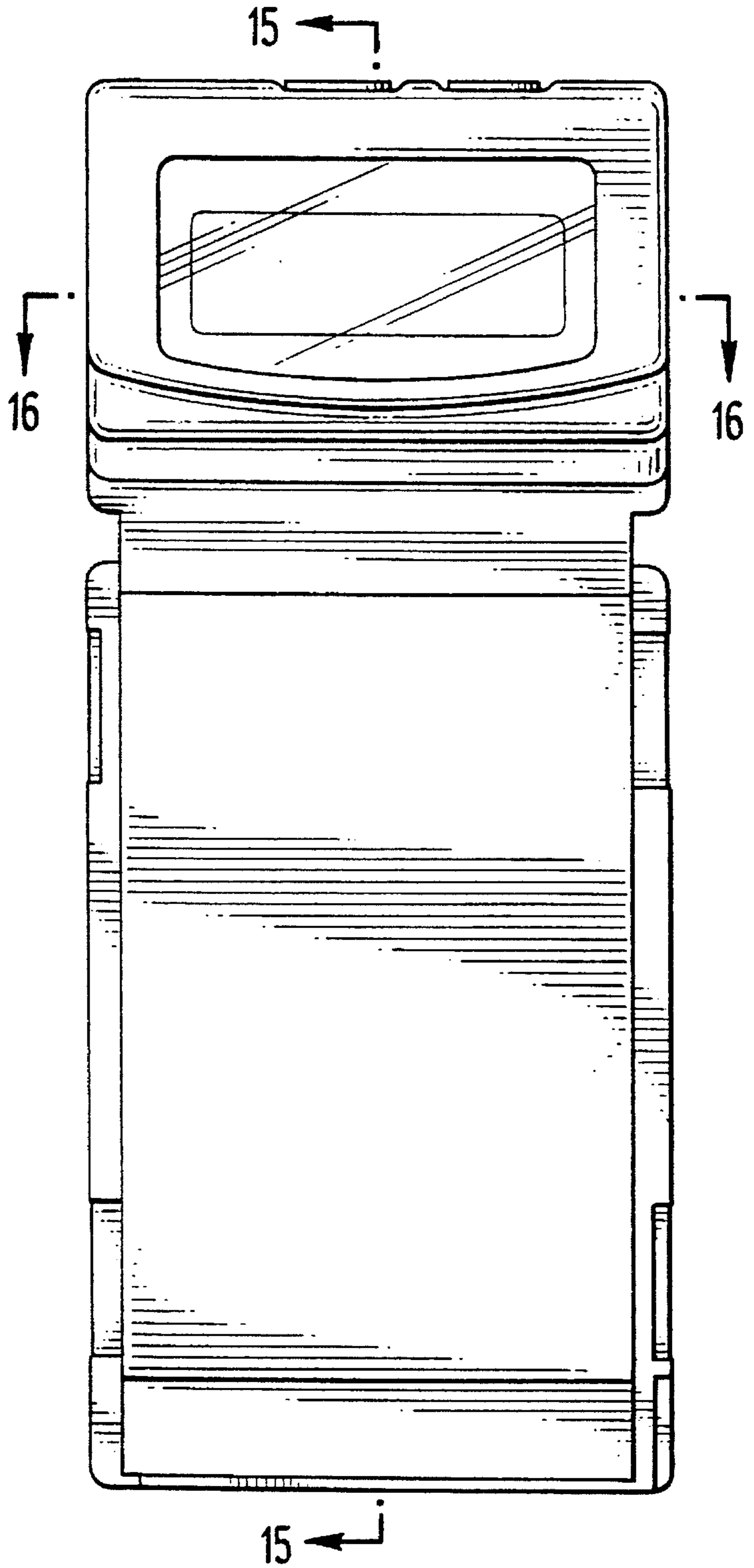

FIG. 9

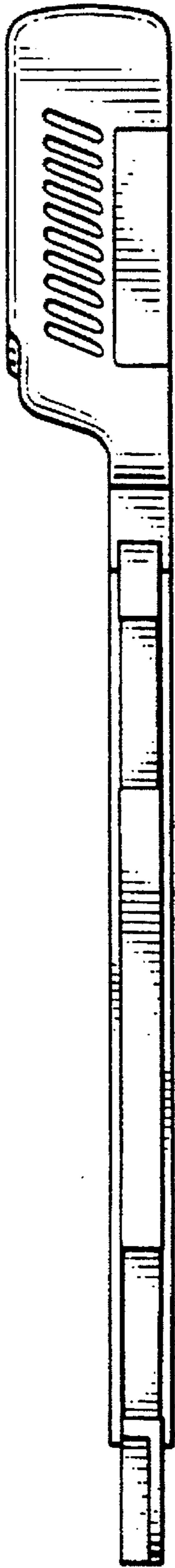

FIG. 11

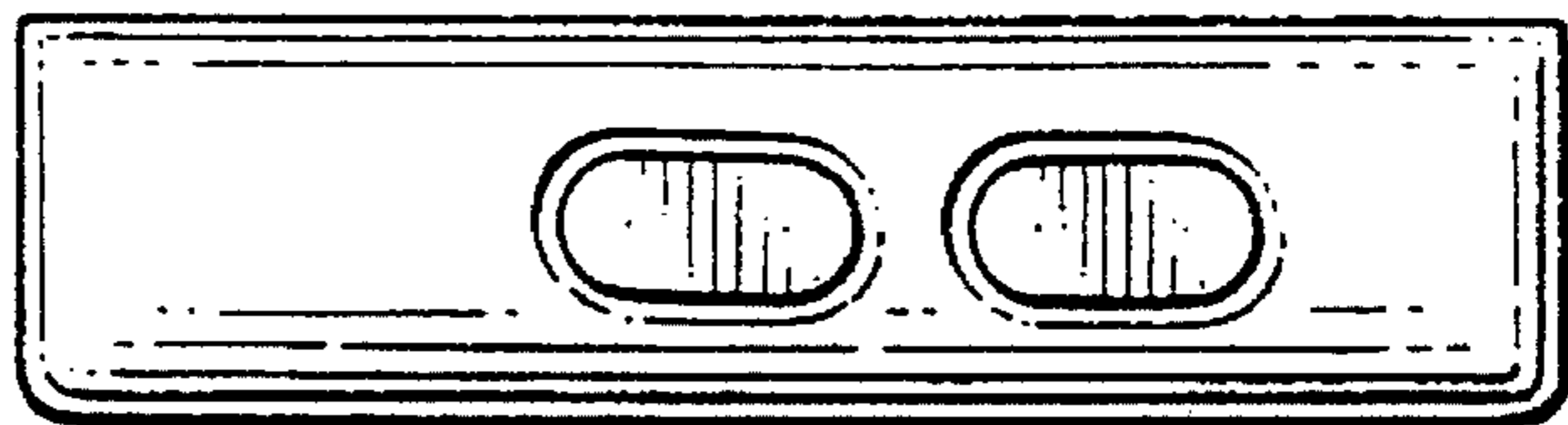

FIG. 12

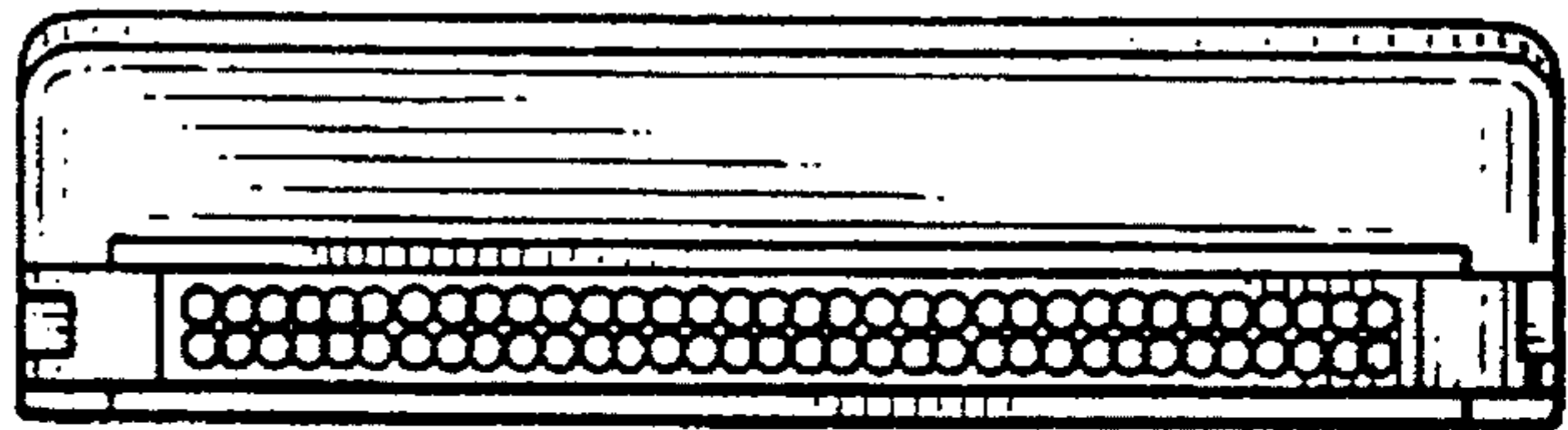

FIG. 13

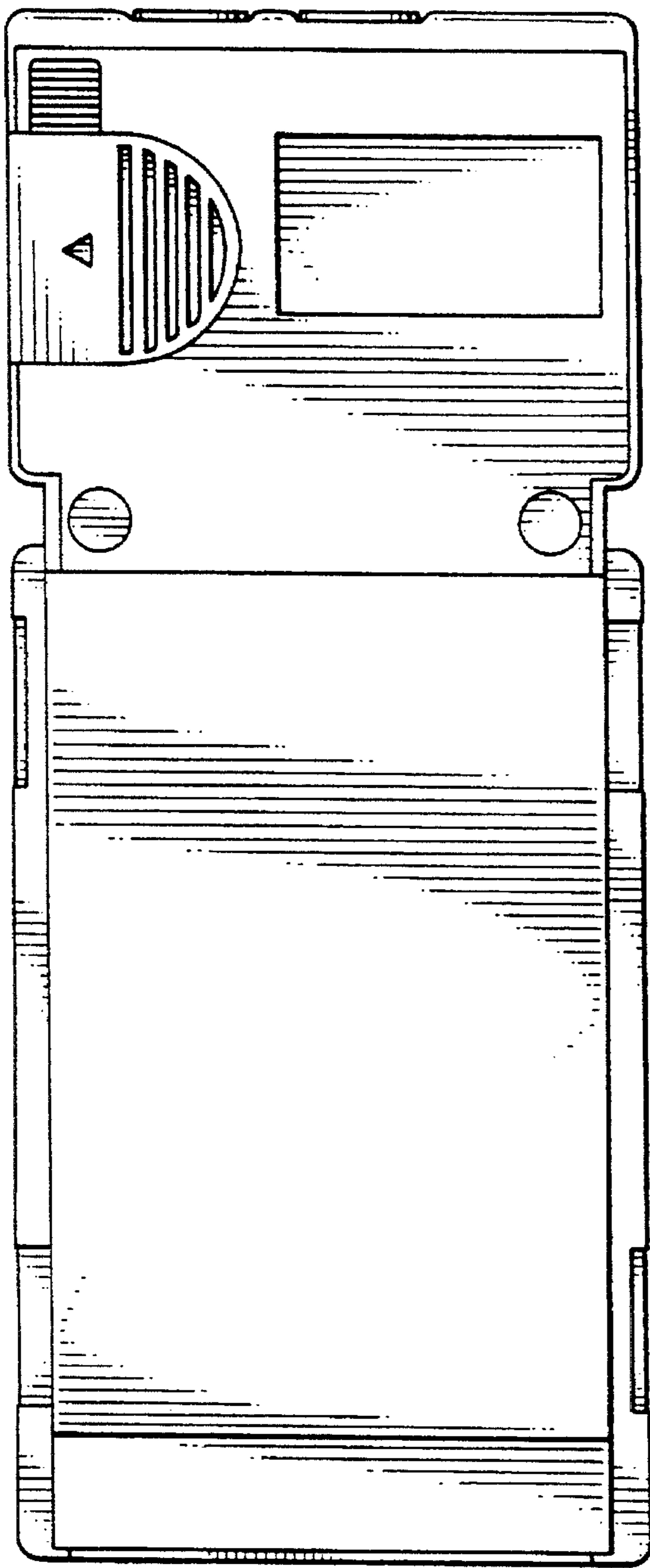

FIG. 14

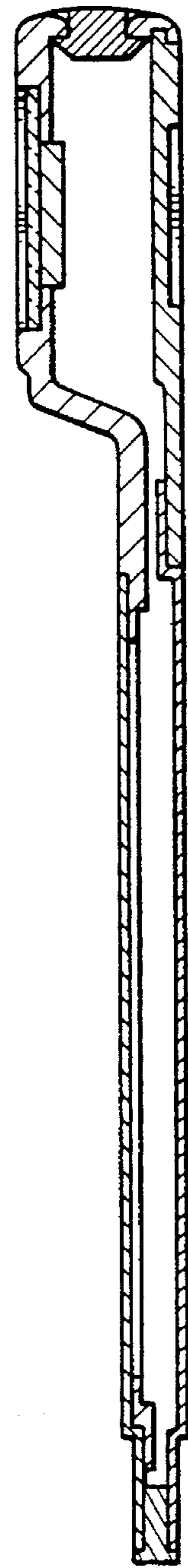

FIG. 15

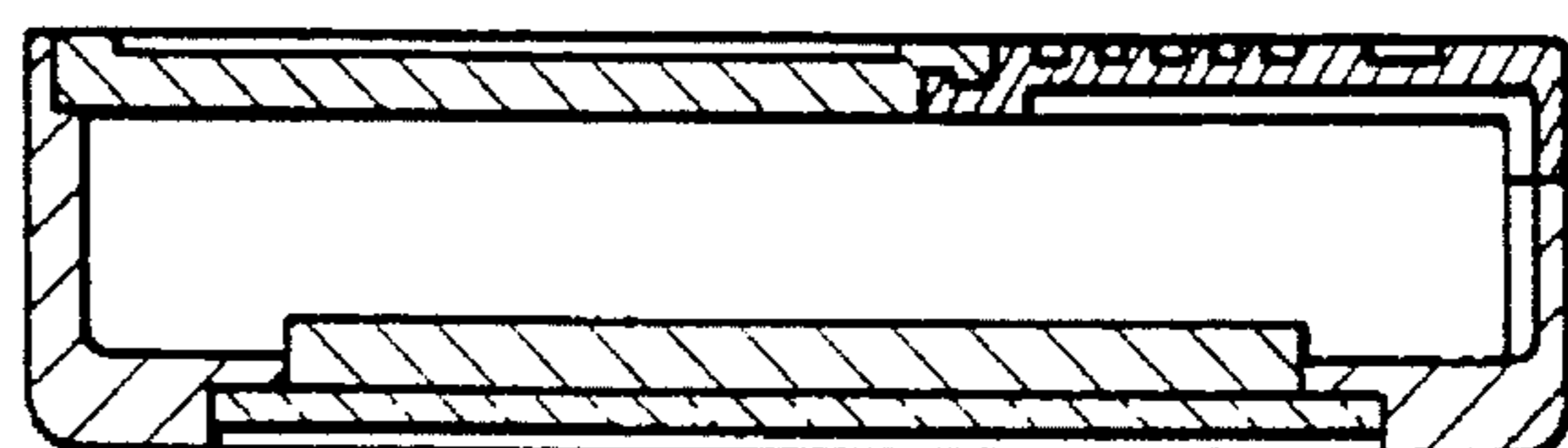

FIG. 16