



US00D367620S

United States Patent [19]

[11] **Patent Number: Des. 367,620**

Sassoli

[45] **Date of Patent: **Mar. 5, 1996**

[54] **ELECTRONIC COUNTER BALANCE**

Primary Examiner—Antoine Duval Davis
Attorney, Agent, or Firm—Bucknam and Archer

[75] Inventor: **Riccardo Sassoli**, Bologna, Italy

[57] **CLAIM**

[73] Assignee: **S.A.R.E.M.A. S.r.l.**, Bologna, Italy

The ornamental design for the electronic counter balance, as shown and described.

[**] Term: **14 Years**

DESCRIPTION

[21] Appl. No.: **13,781**

FIG. 1 is a perspective view of an electronic counter balance showing my new design;

[22] Filed: **Oct. 1, 1993**

FIG. 2 is a front elevation view;

[30] **Foreign Application Priority Data**

FIG. 3 is a rear elevation view;

Apr. 13, 1993 [WO] WIPO DM/025810

FIG. 4 is a left side elevation view;

[52] **U.S. Cl.** **D10/91**

FIG. 5 is a right side elevation view; and,

[58] **Field of Search** D10/91, 92; 177/238-242

FIG. 6 is a top plan view thereof;

[56] **References Cited**

All indica, except for the trade names, have been eliminated for ease of illustration in FIGS. 1 and 2.

U.S. PATENT DOCUMENTS

D. 260,377 8/1981 Lawing D10/91

D. 261,241 10/1981 Lawing D10/91

1 Claim, 6 Drawing Sheets

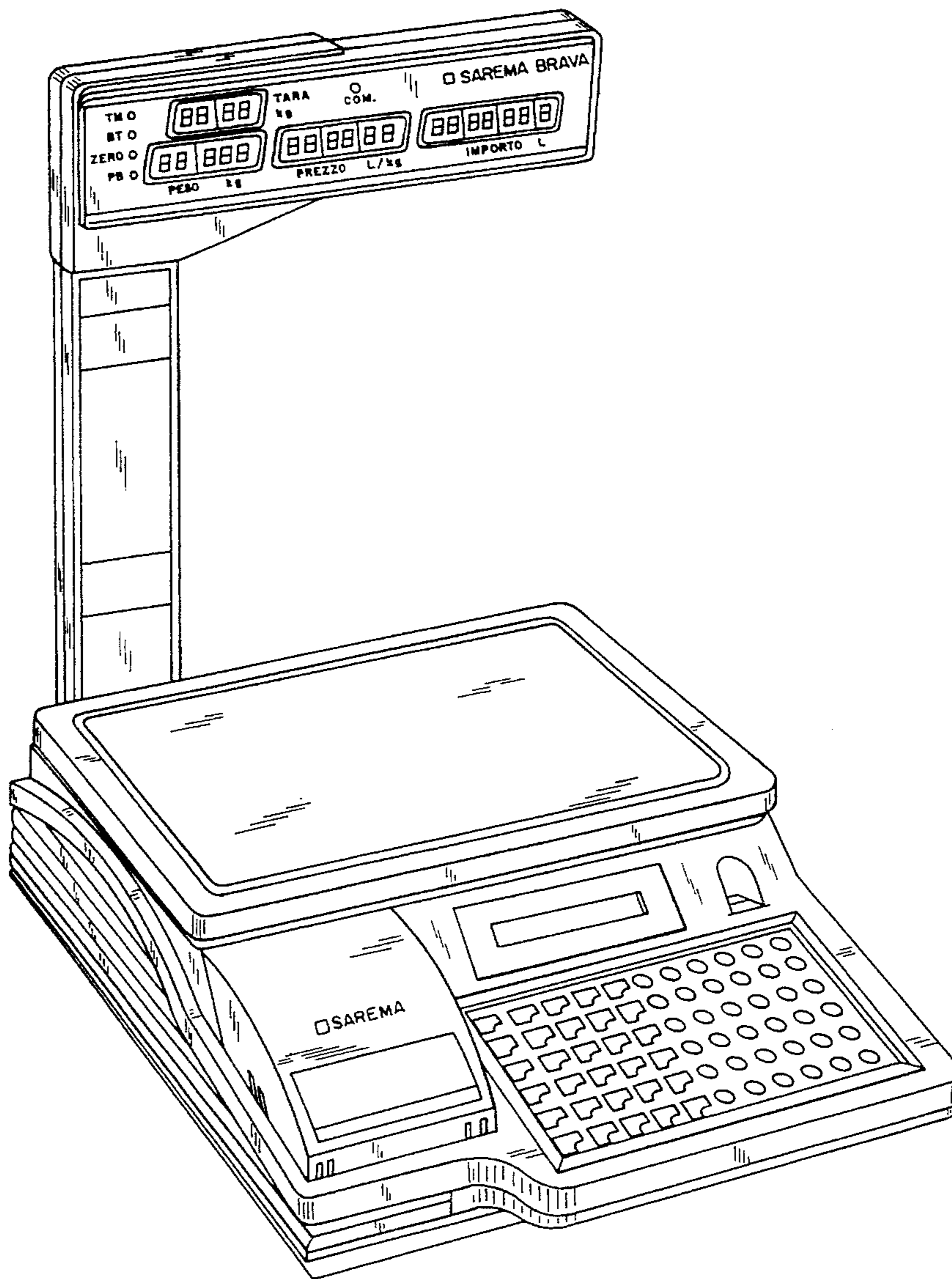

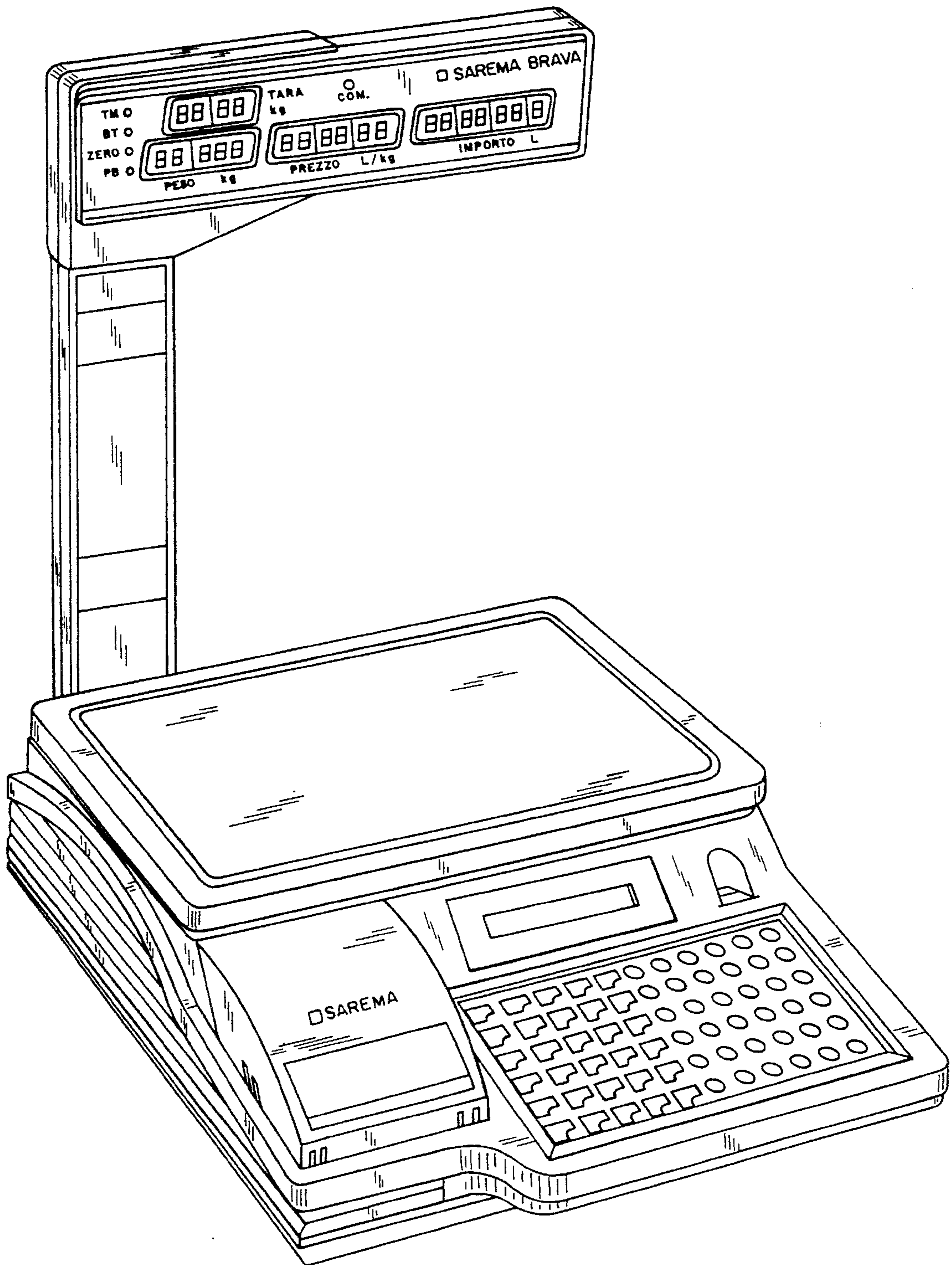

FIG. 1

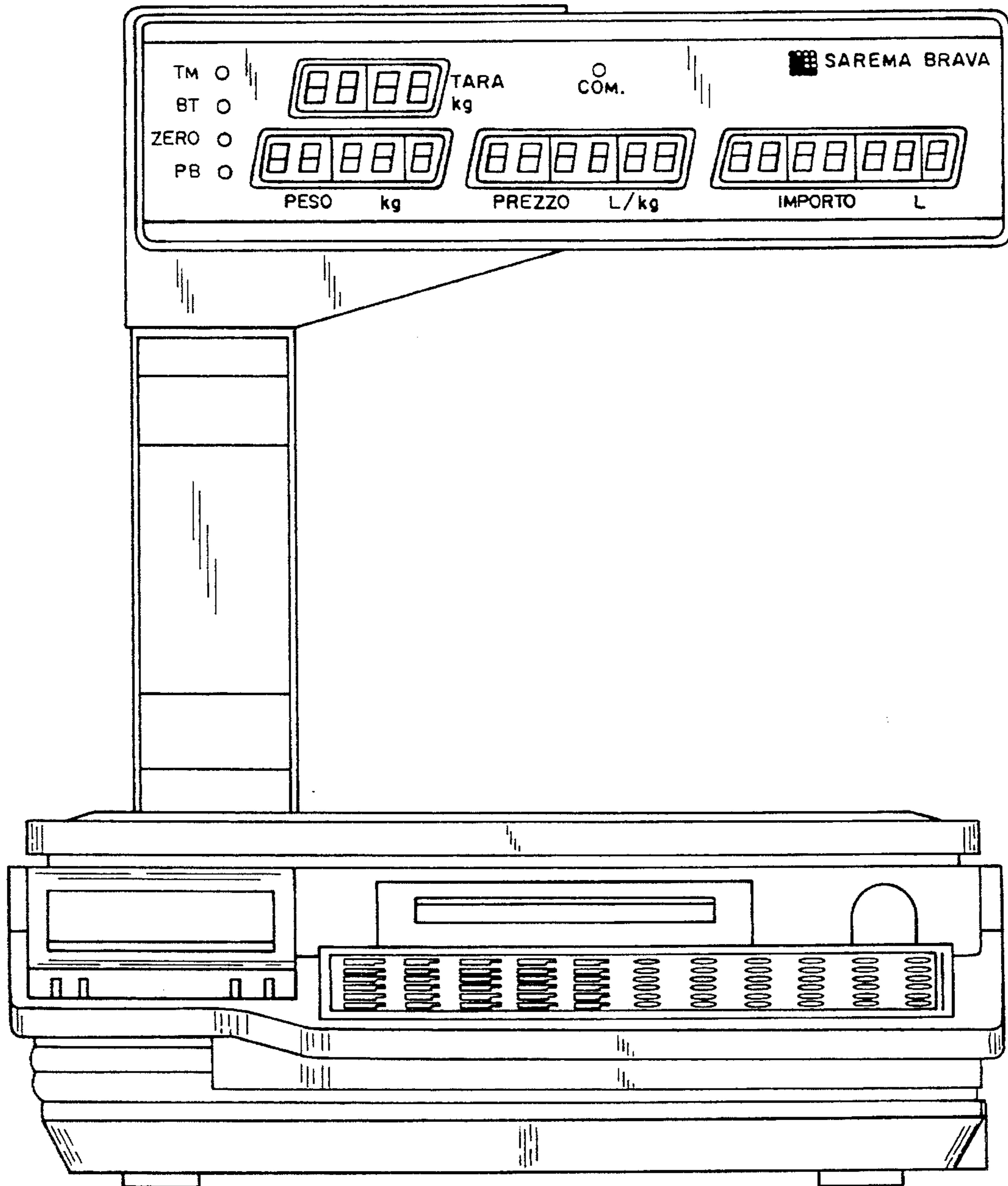

FIG.2

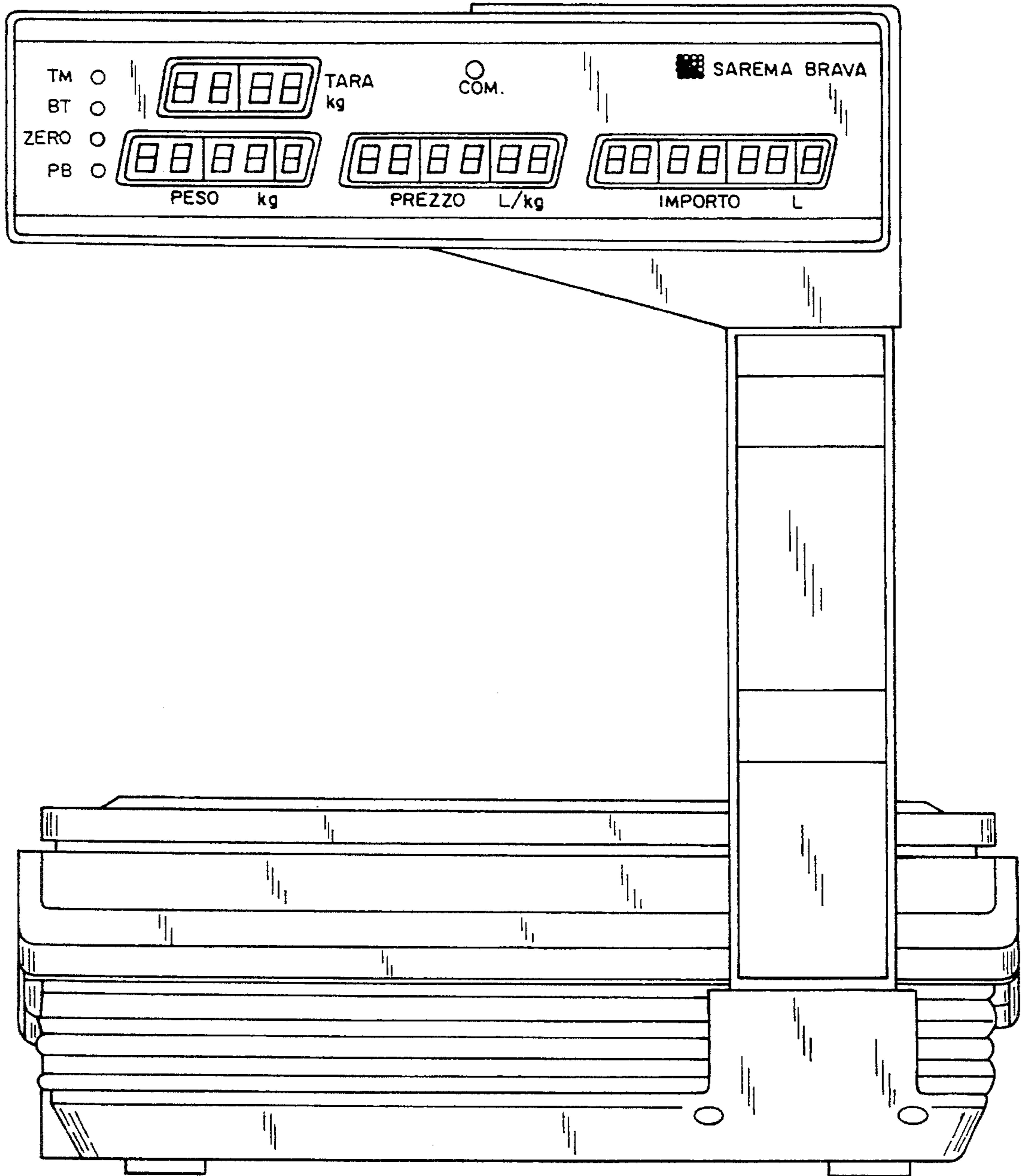

FIG.3

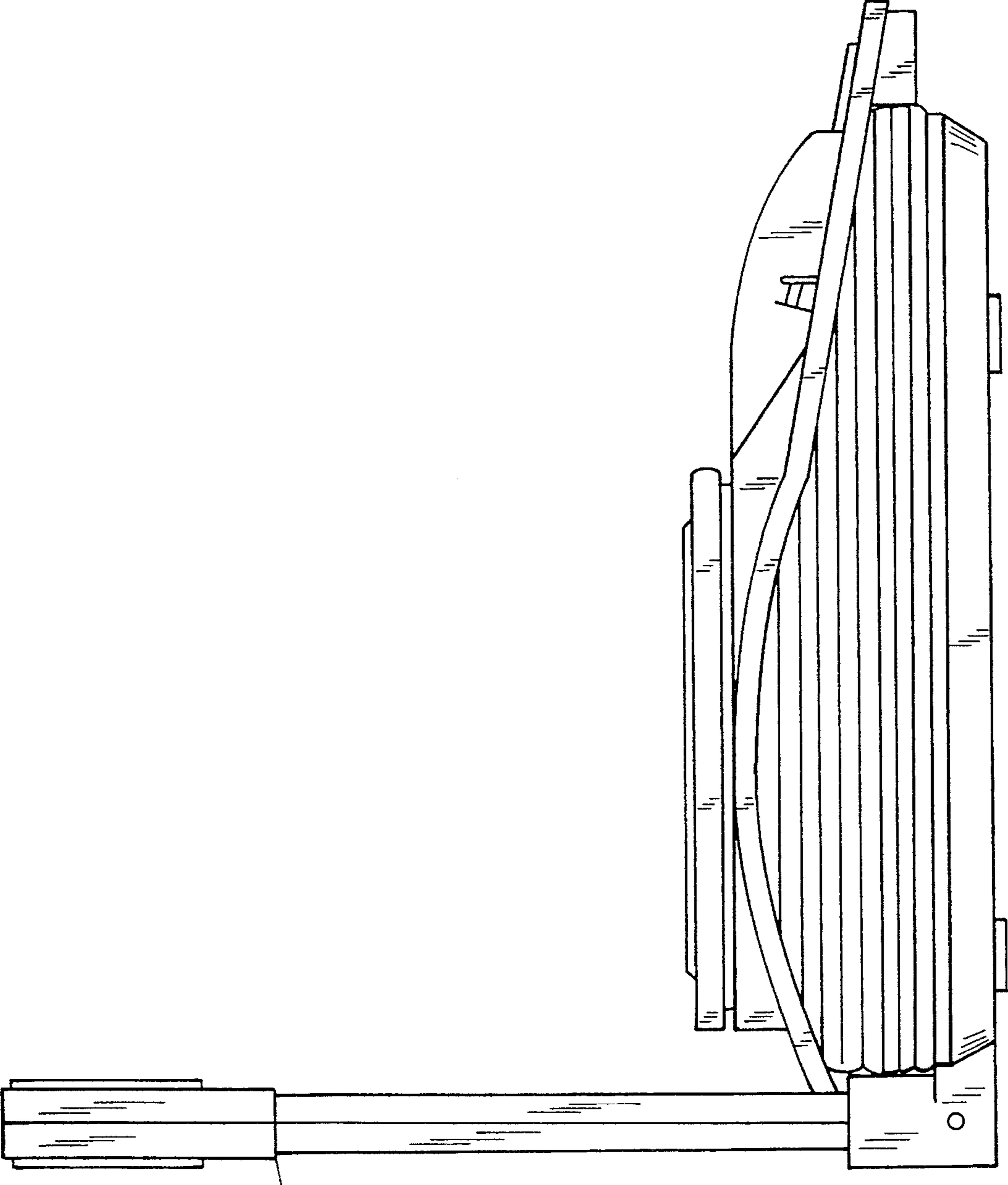

FIG.4

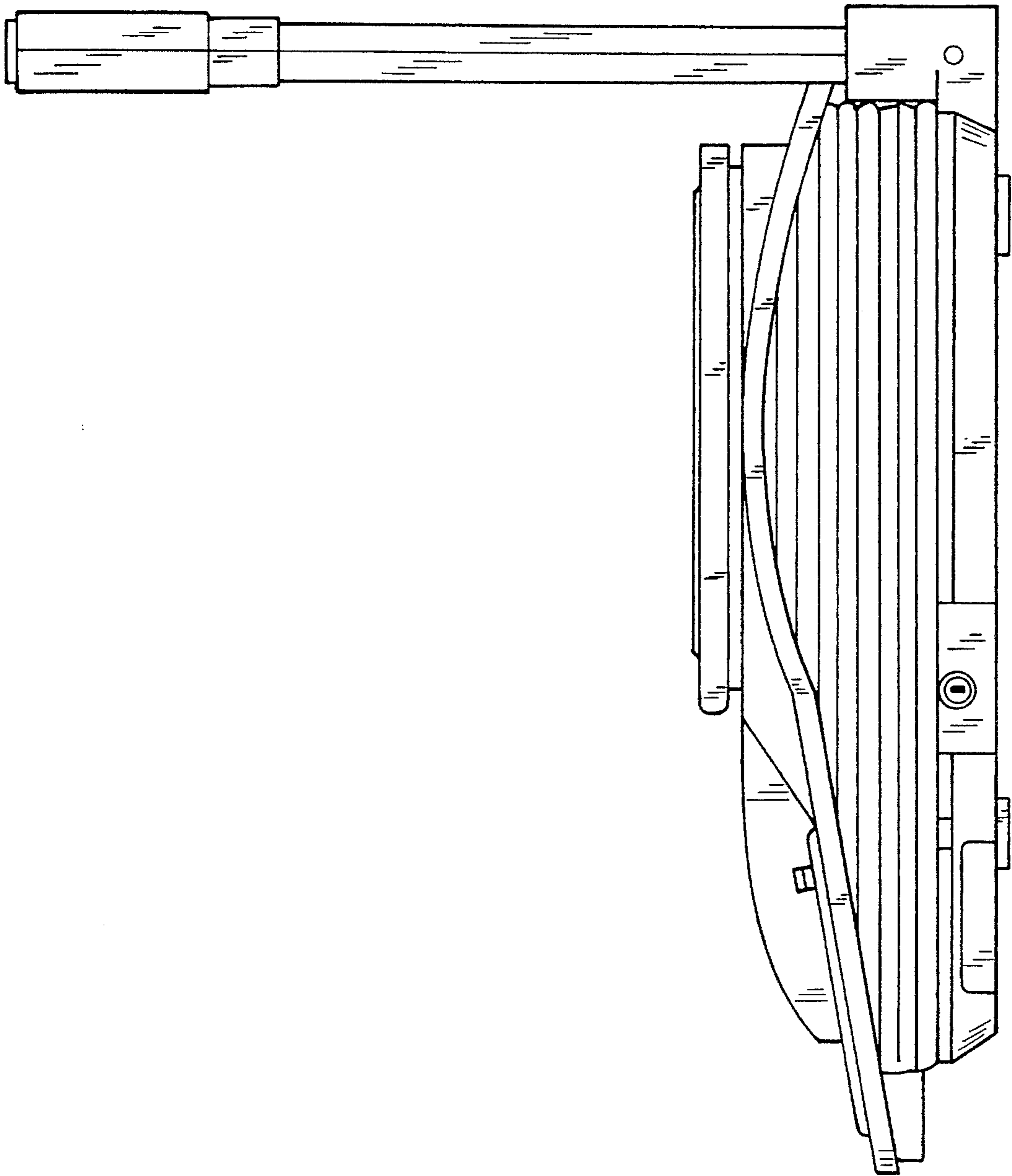

FIG. 5

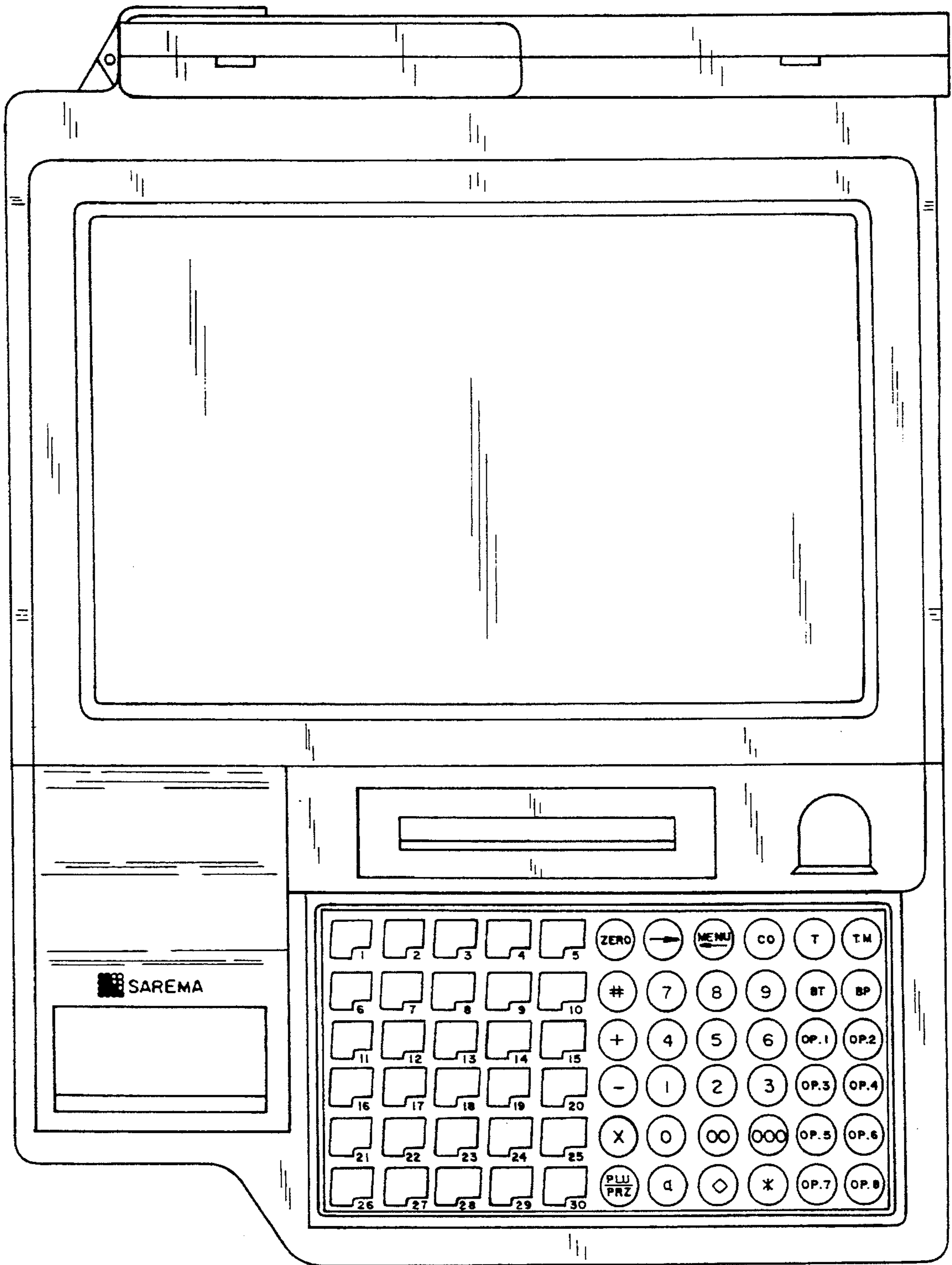

FIG.6