



US00D367584S

United States Patent [19] Koch

[11] Patent Number: **Des. 367,584**

[45] Date of Patent: ****Mar. 5, 1996**

[54] **HANDLE FOR A KITCHEN UTENSIL**

[75] Inventor: **Karl-Erich Koch**, Cham, Switzerland

[73] Assignee: **AMC International ALFA Metalcraft Corporation AG**, Switzerland

[**] Term: **14 Years**

[21] Appl. No.: **15,720**

[22] Filed: **Nov. 24, 1993**

[30] **Foreign Application Priority Data**

May 26, 1993 [XH] Hague Agreement DM/026222

[52] U.S. Cl. **D7/394**

[58] Field of Search D7/354-360, 393, D7/394; 16/110 R, 110 A; 220/752

[56] **References Cited**

U.S. PATENT DOCUMENTS

D. 284,539 7/1986 Baumgarten D7/394 X

D. 340,164 10/1993 Koch D7/363

FOREIGN PATENT DOCUMENTS

0087276 8/1959 Denmark 220/752

67853 11/1978 WIPO .

OTHER PUBLICATIONS

Eight (8) sheets bearing the AMC logo, date unknown.

Primary Examiner—Alan P. Douglas

Assistant Examiner—Caron D. Veynar

Attorney, Agent, or Firm—Webb Ziesenheim Bruening
Logsdon Orkin & Hanson

[57] **CLAIM**

The ornamental design for the handle for a kitchen utensil, as shown and described.

DESCRIPTION

FIG. 1 is a perspective view of a handle for a kitchen utensil showing my new design;

FIG. 2 is a top plan view thereof;

FIG. 3 is a front elevational view thereof;

FIG. 4 is a left side elevational view thereof;

FIG. 5 is a bottom plan view thereof;

FIG. 6 is a rear elevational view thereof;

FIG. 7 is a right side elevational view thereof;

FIG. 8 is a perspective view of a second embodiment of the handle for a kitchen utensil;

FIG. 9 is a top plan view thereof;

FIG. 10 is a front elevational view thereof;

FIG. 11 is a left side elevational view thereof;

FIG. 12 is a bottom plan view thereof;

FIG. 13 is a rear elevational view thereof;

FIG. 14 is a right side elevational view thereof;

FIG. 15 is a perspective view of a third embodiment of a handle for a kitchen utensil identical to the handle shown in FIGS. 1-7. The only difference being the stippling which represents an area of different color; and,

FIG. 16 is a perspective view of a fourth embodiment of a handle for a kitchen utensil identical to the handle shown in FIGS. 8-14. The only difference being the stippling which represents an area of different color.

1 Claim, 8 Drawing Sheets

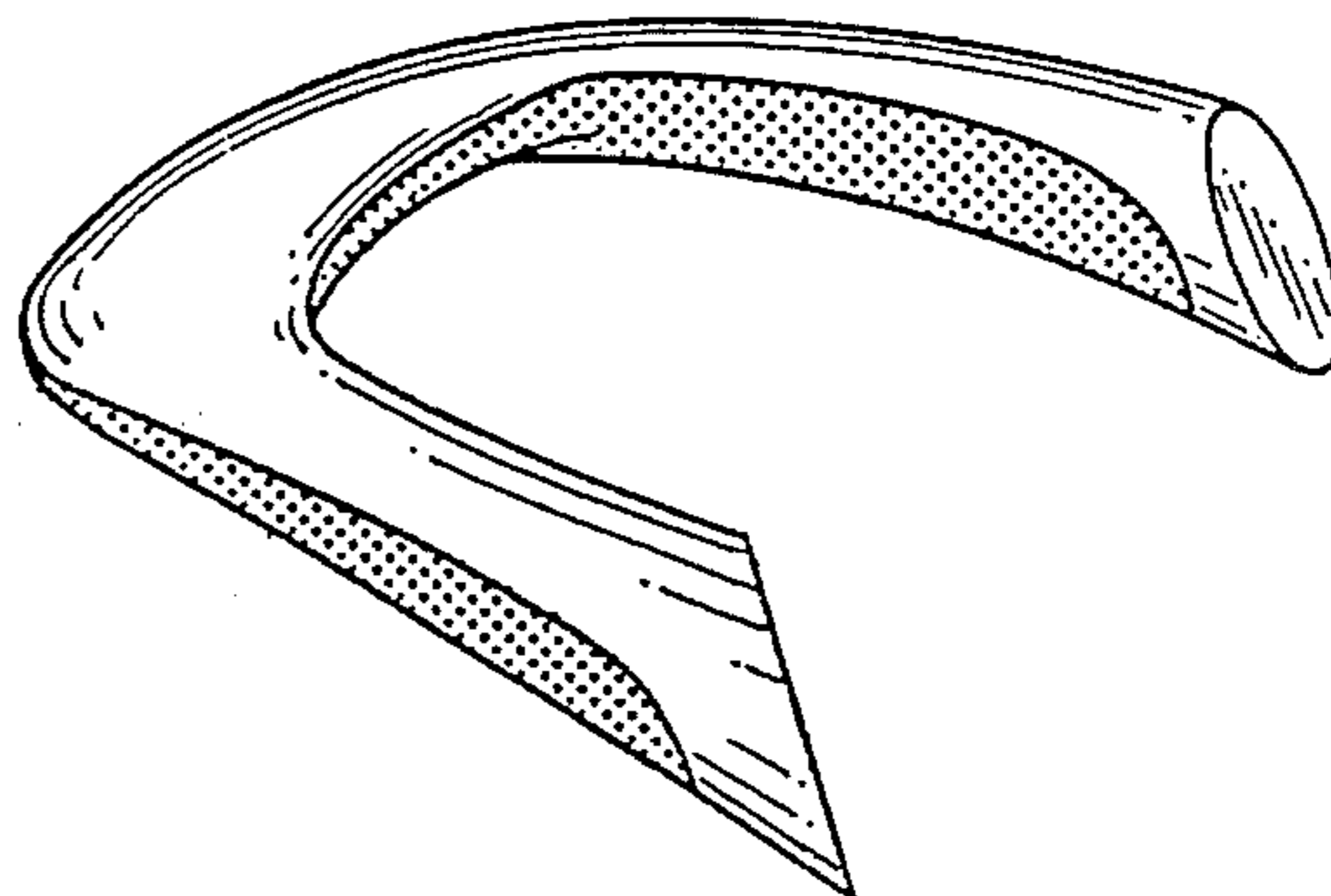
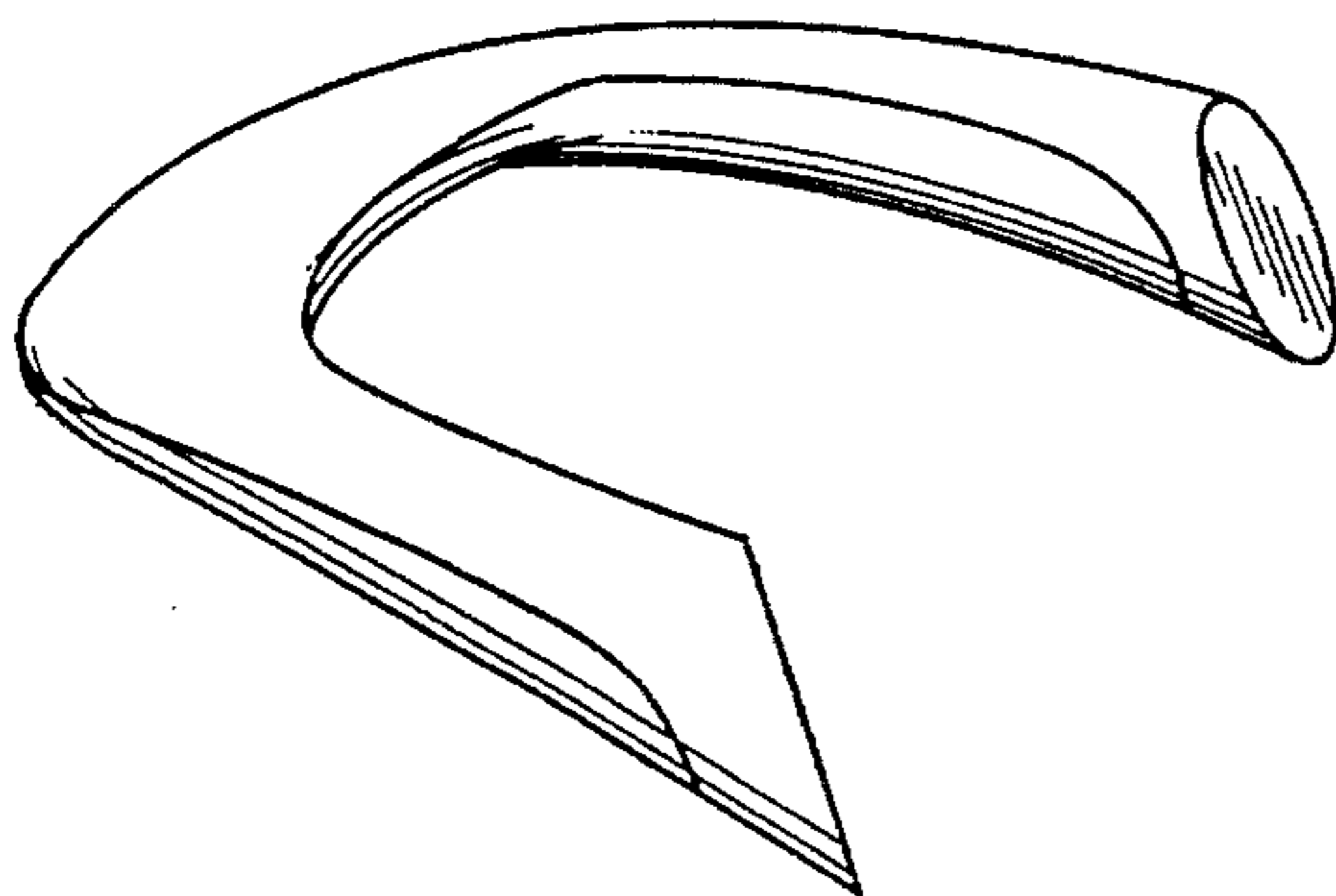
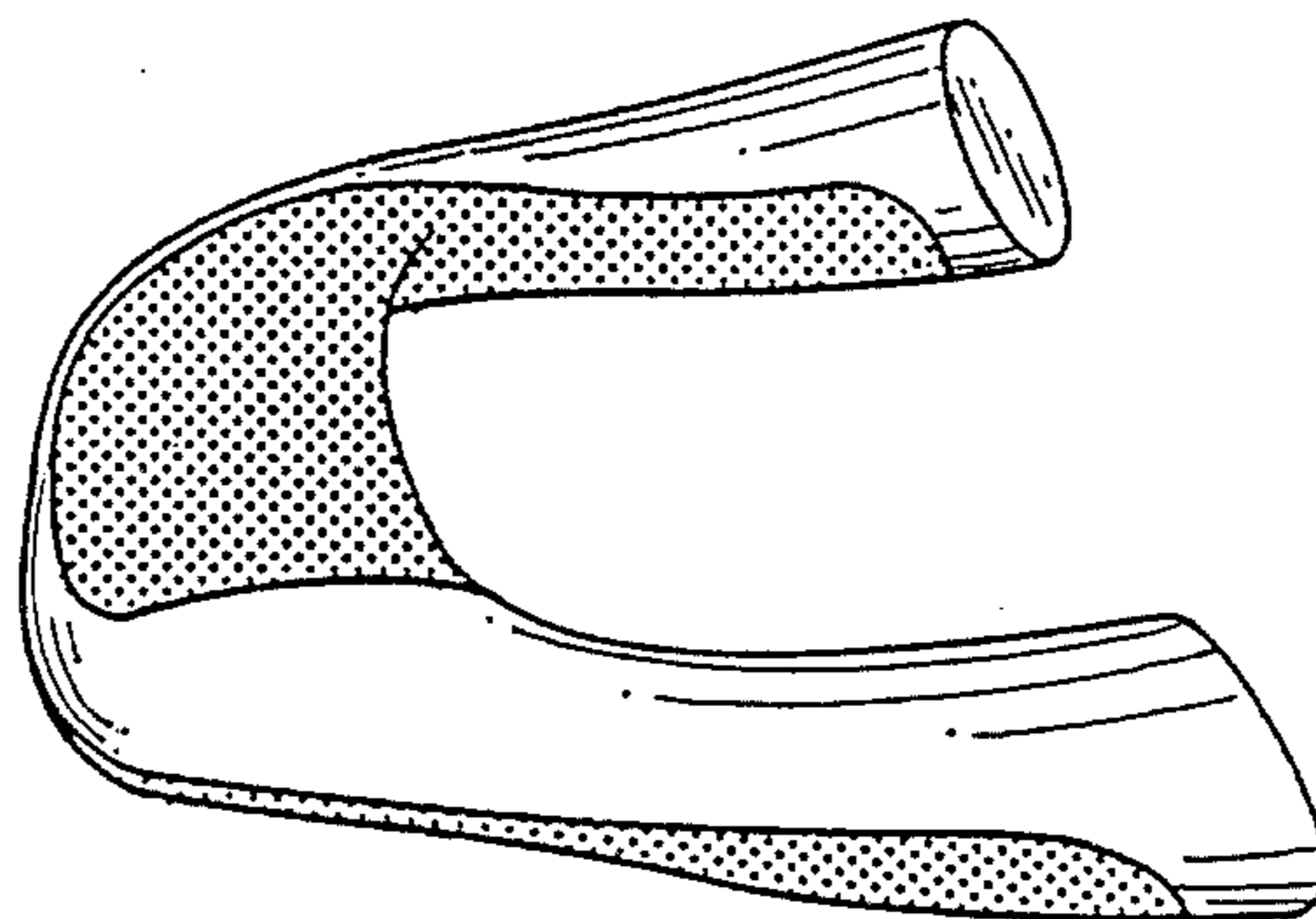
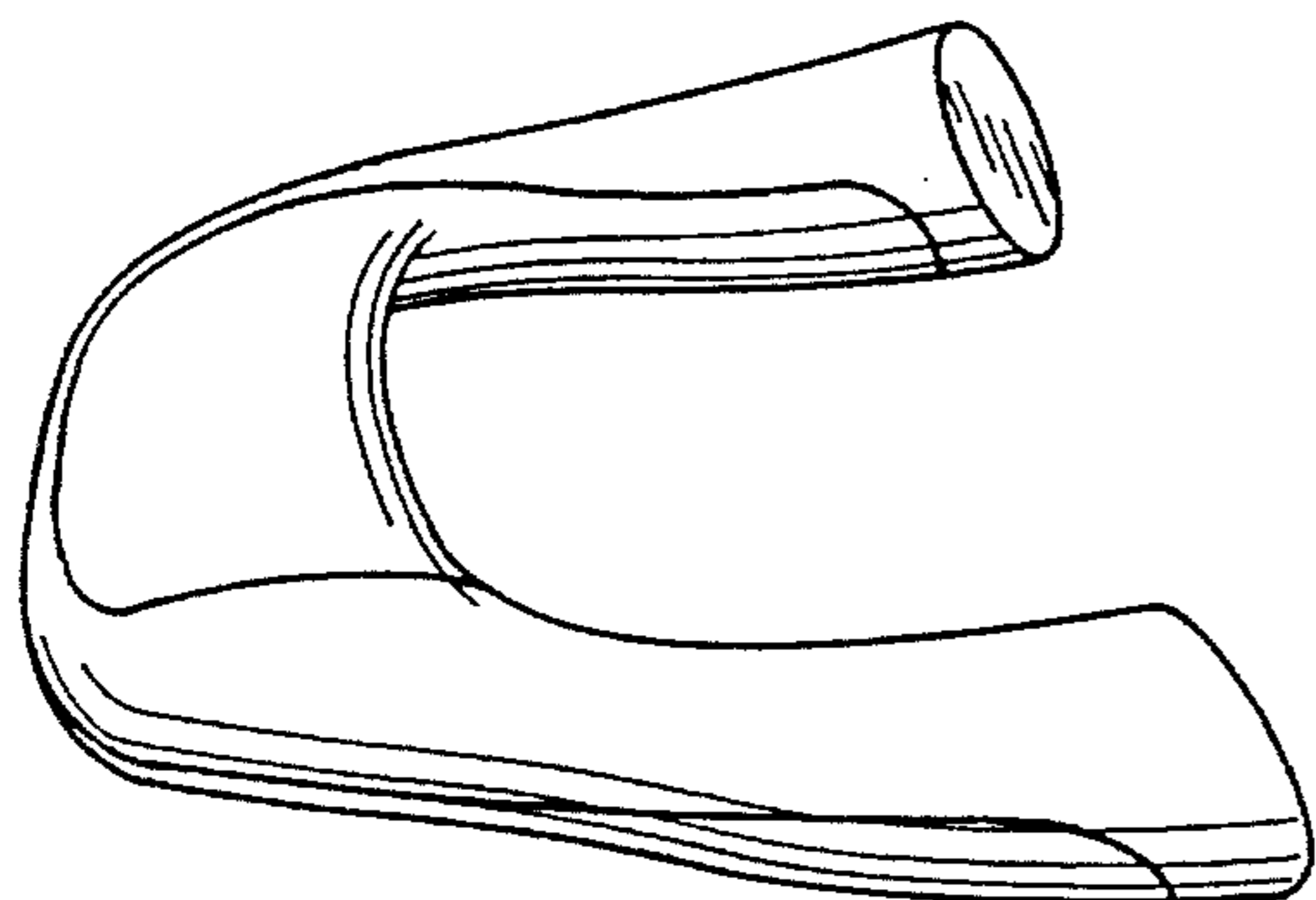

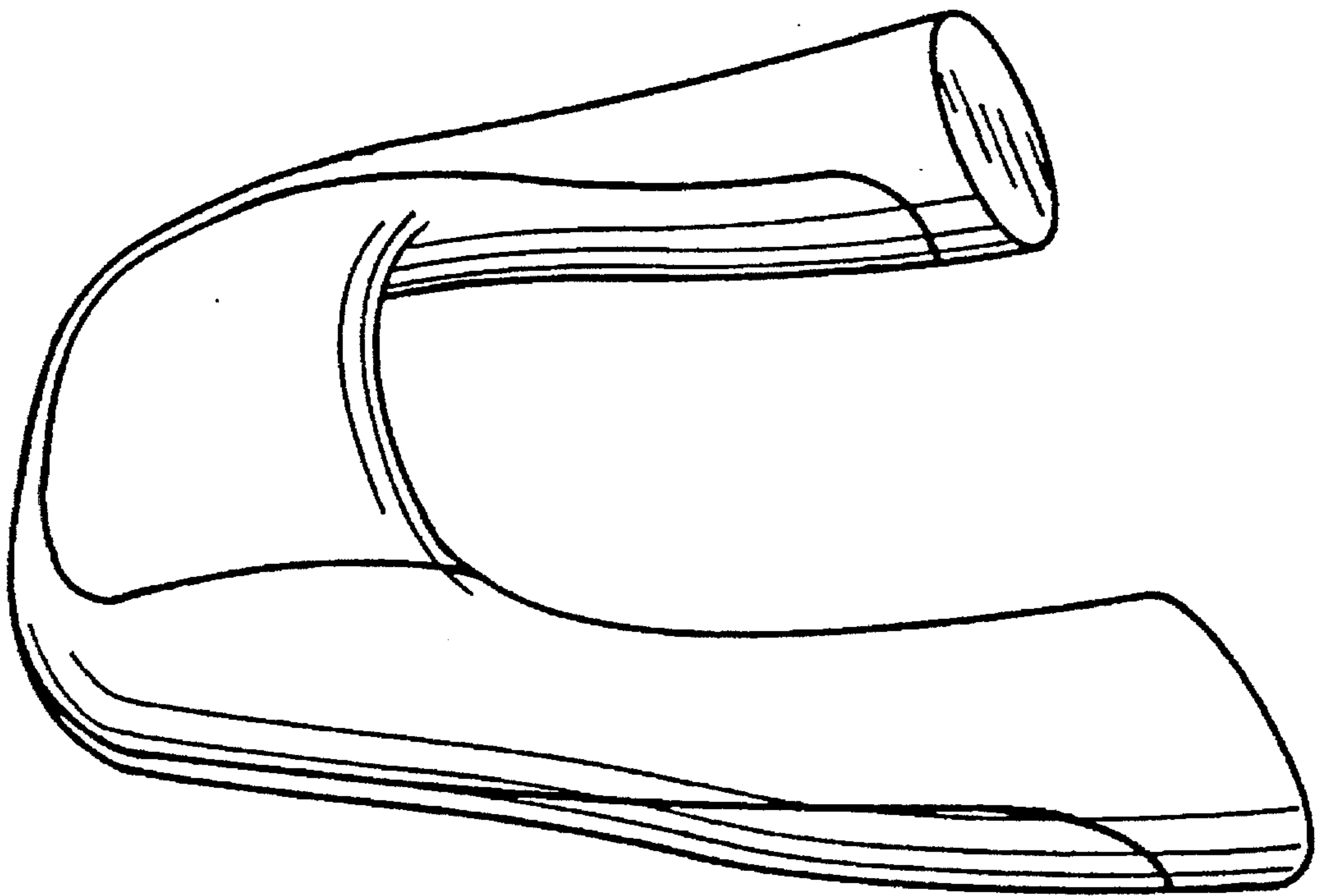

FIG. 1

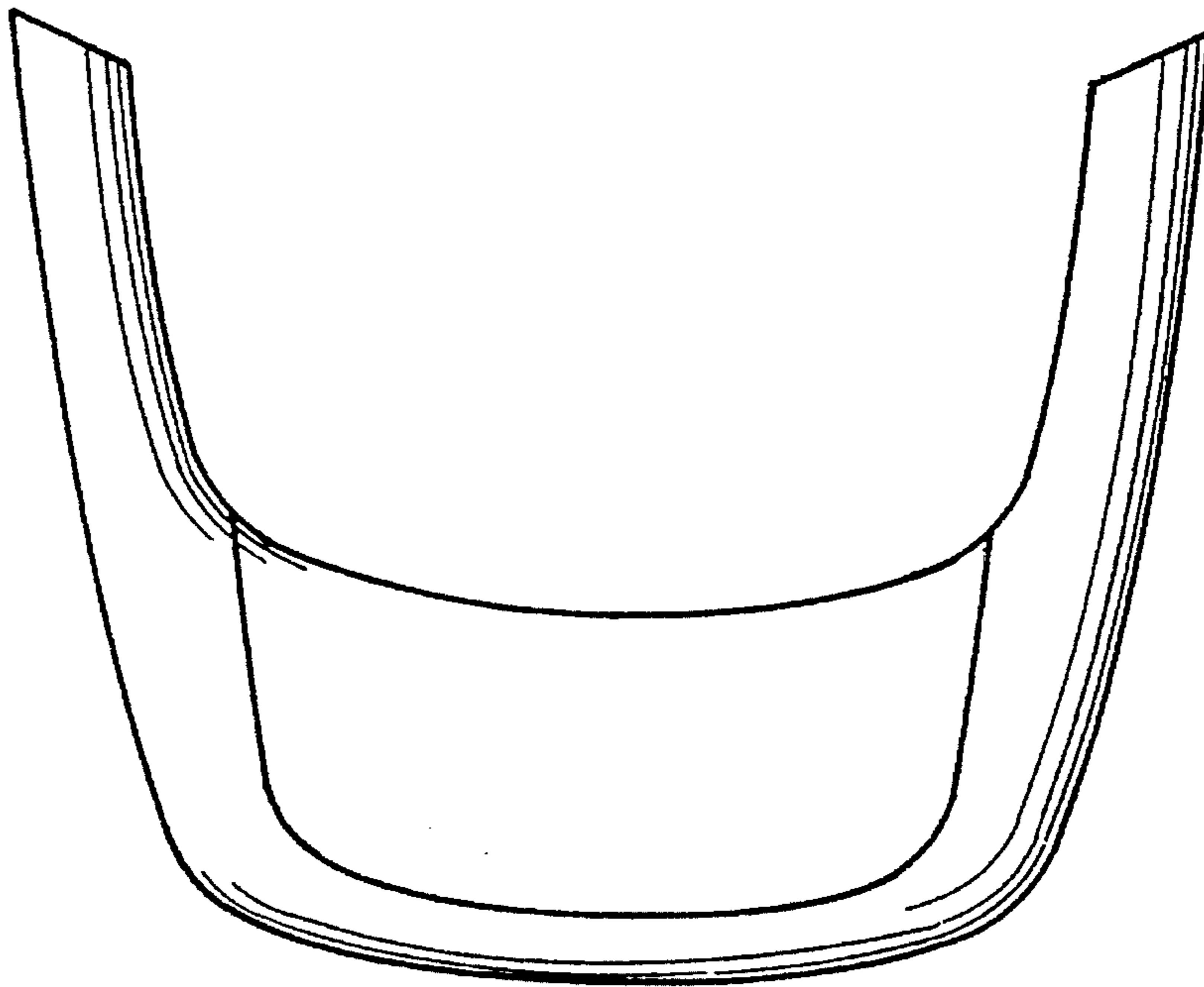

FIG. 2

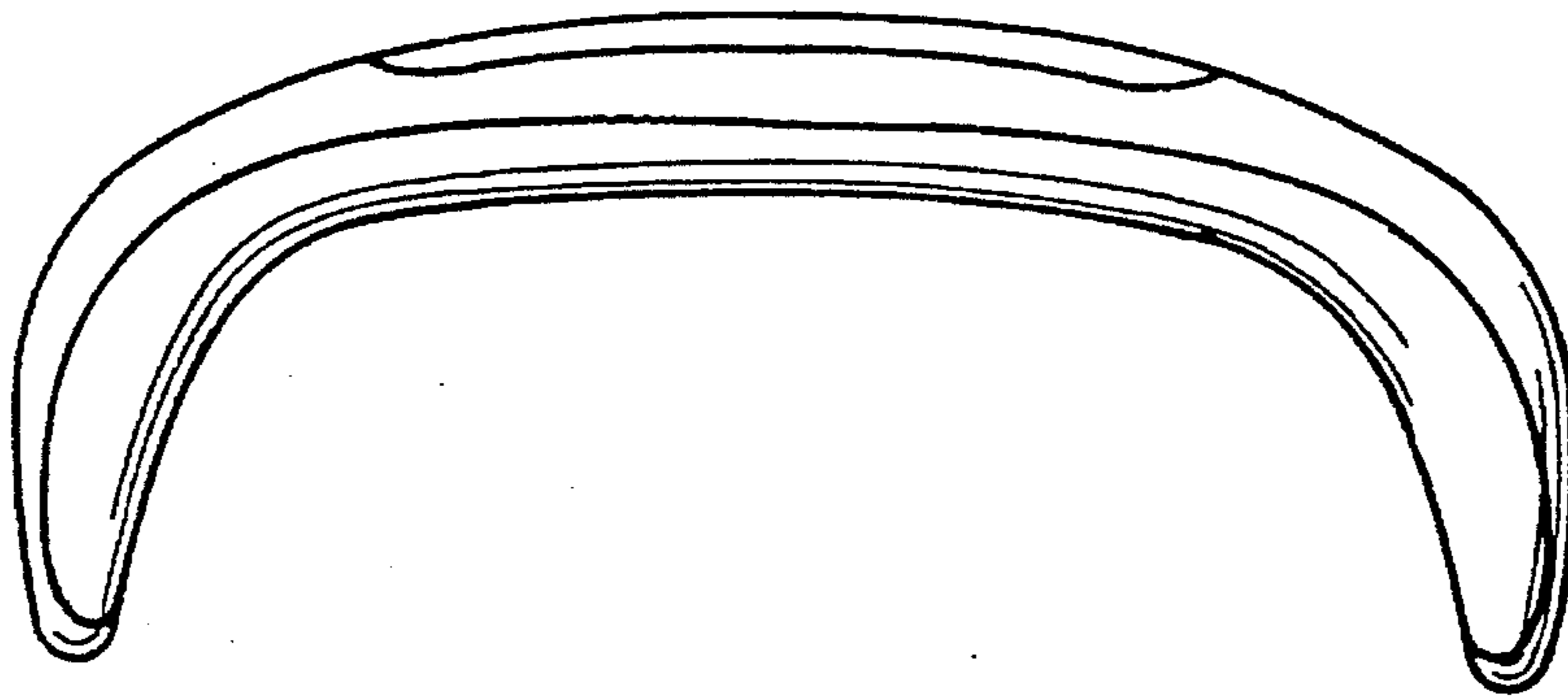

FIG. 3

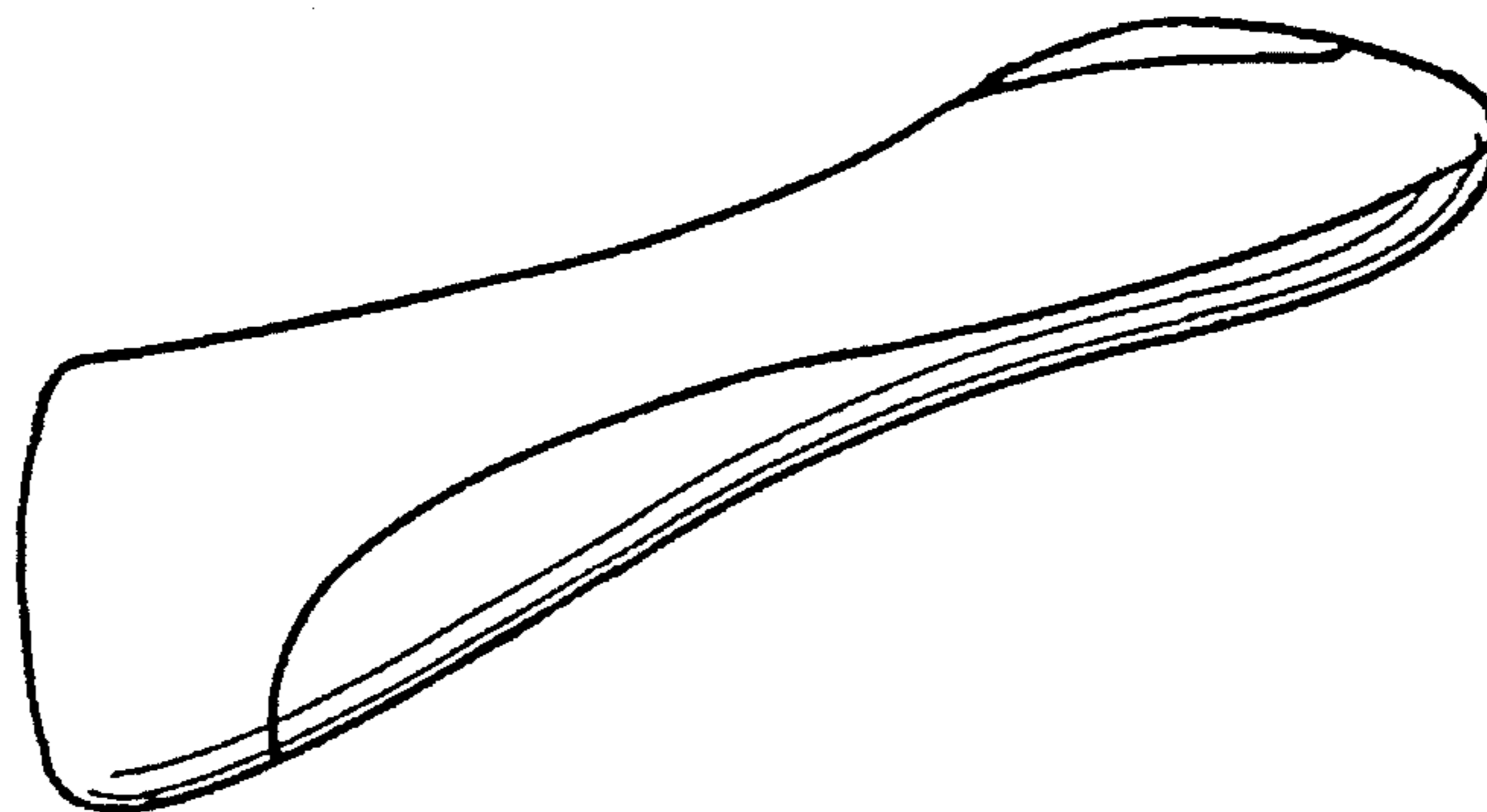

FIG. 4

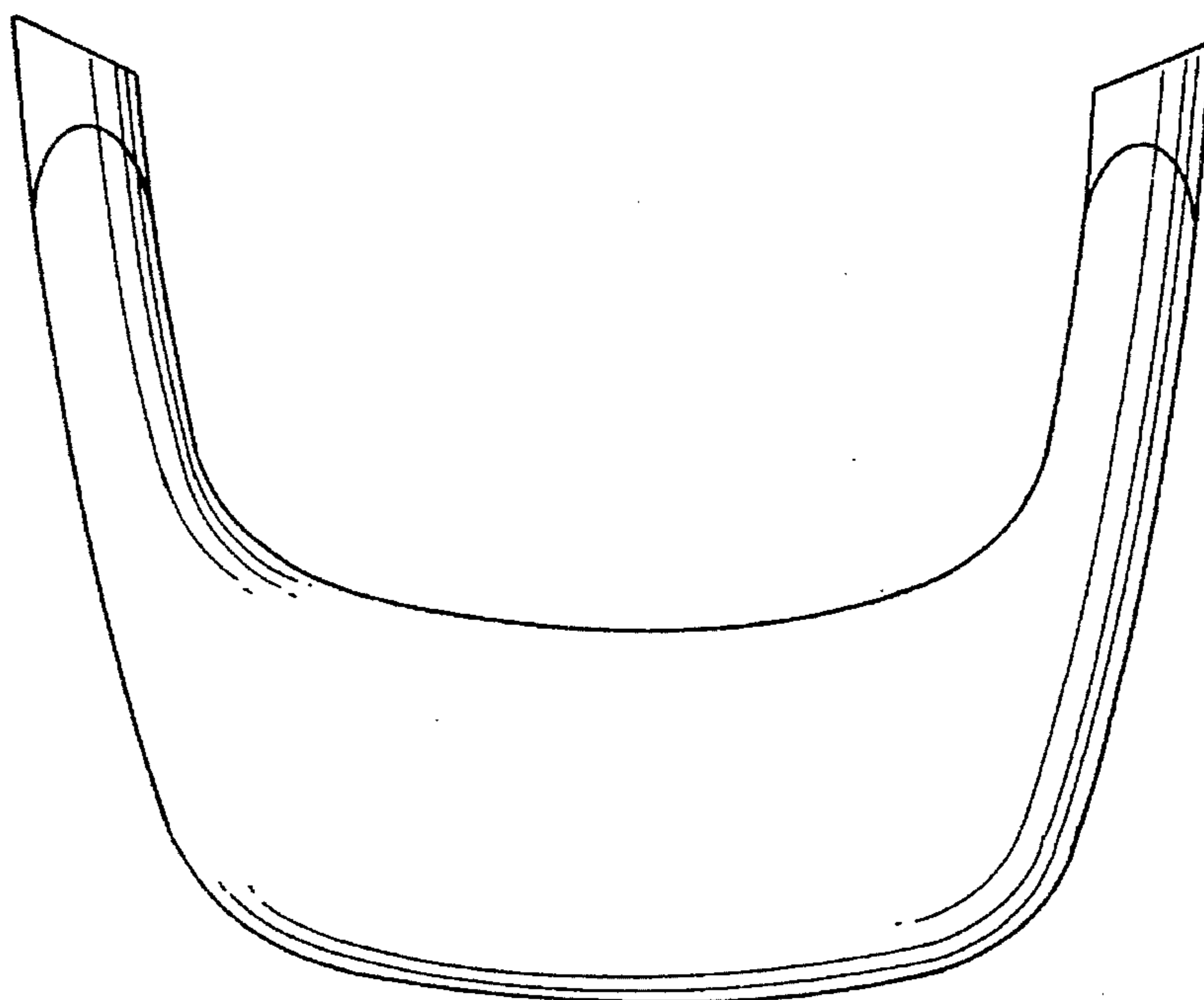

FIG. 5

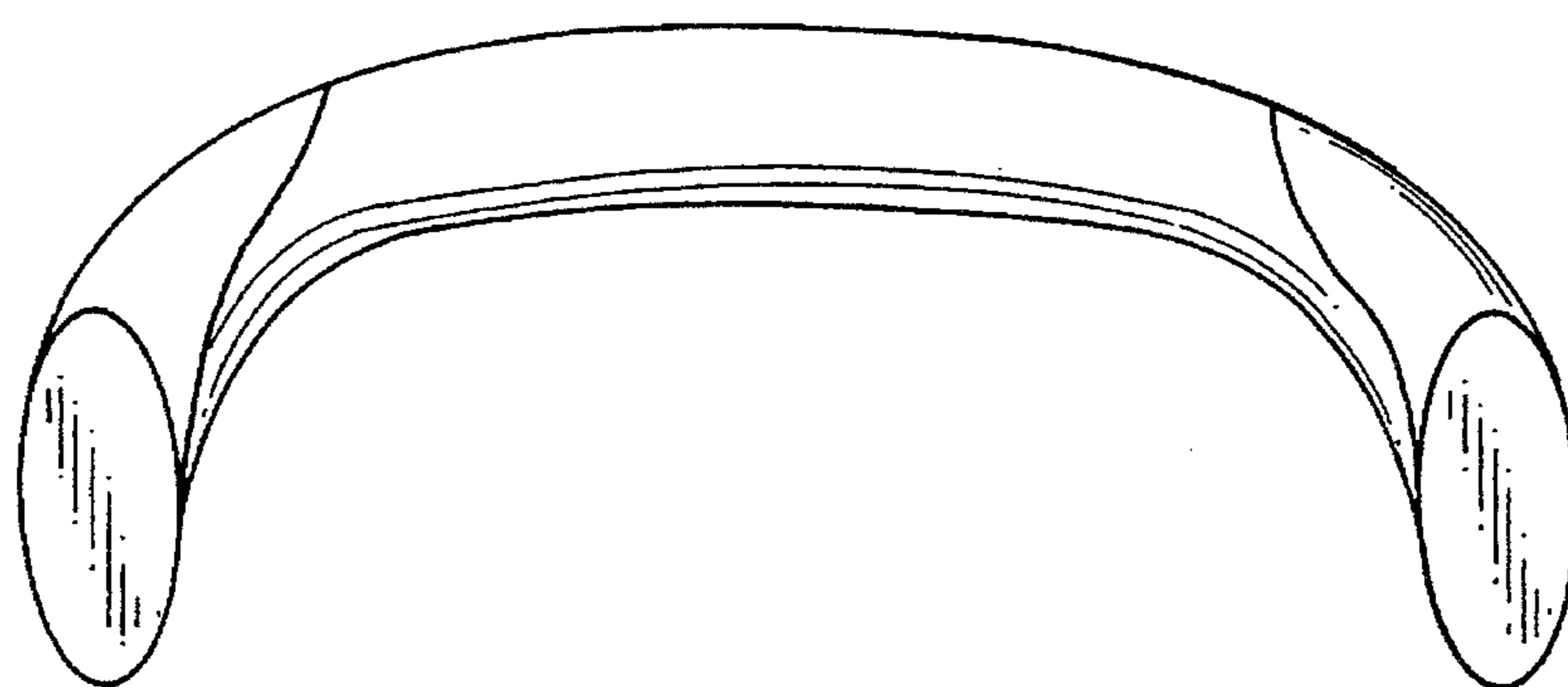

FIG. 6

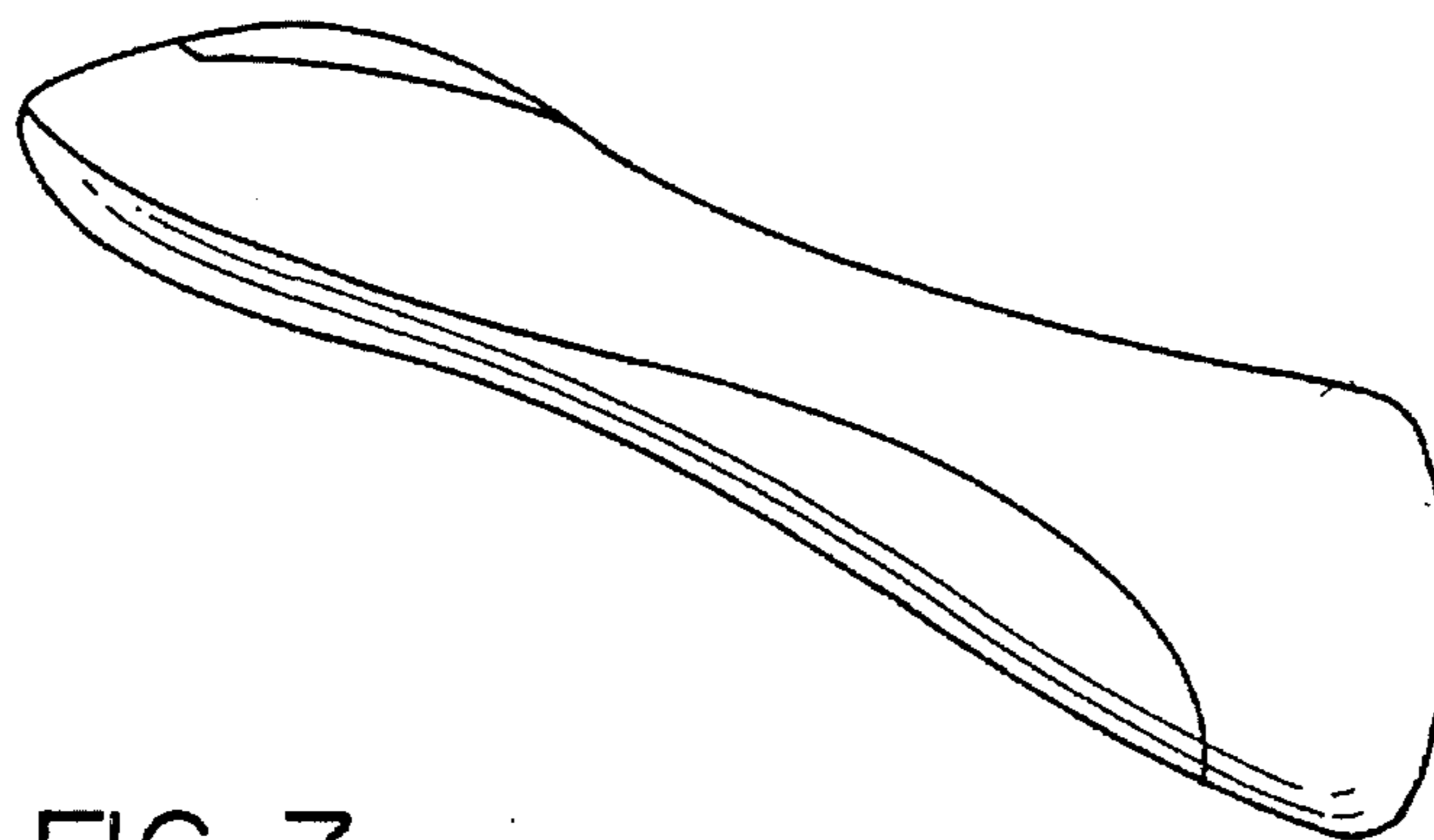

FIG. 7

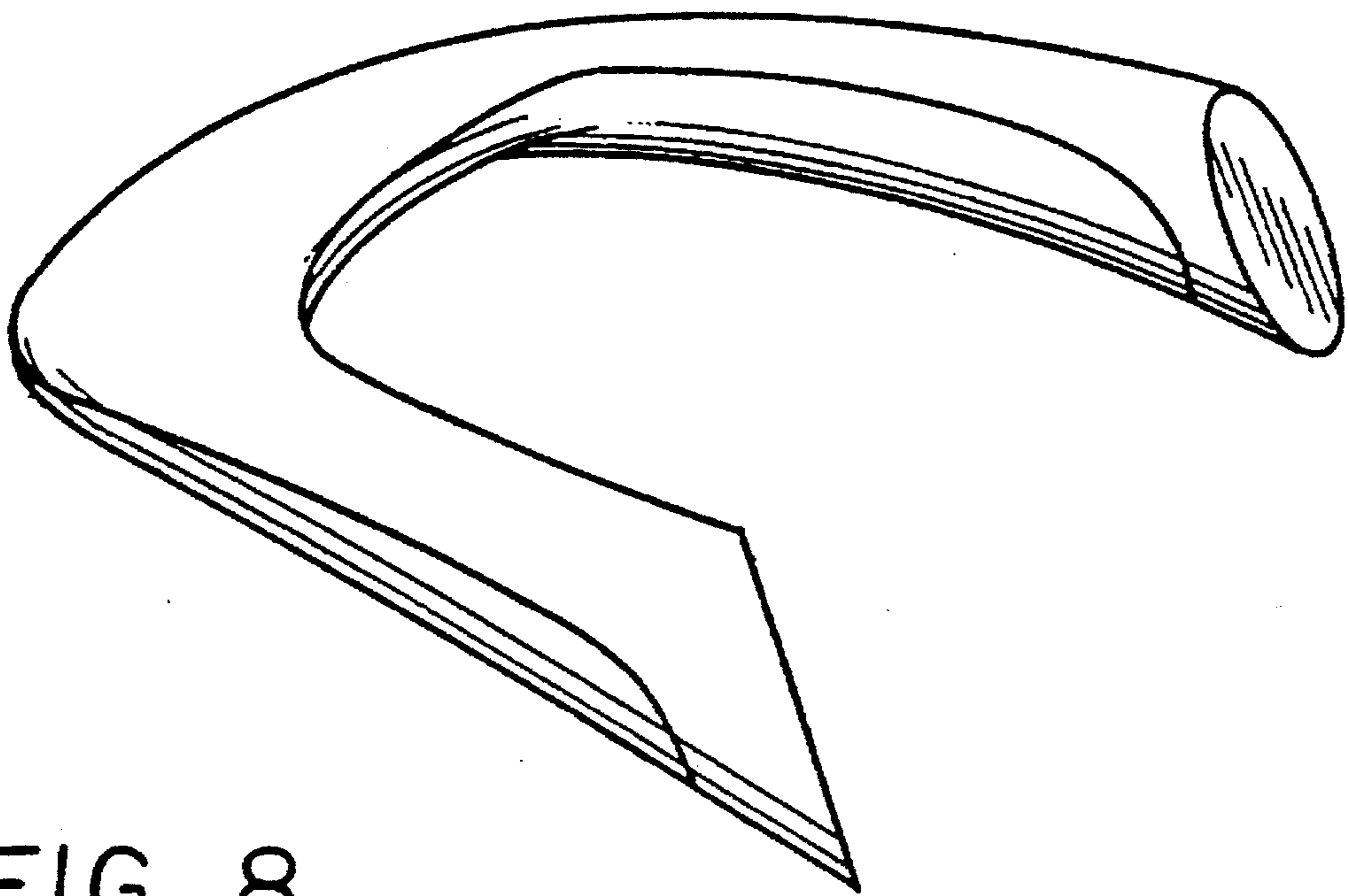

FIG. 8

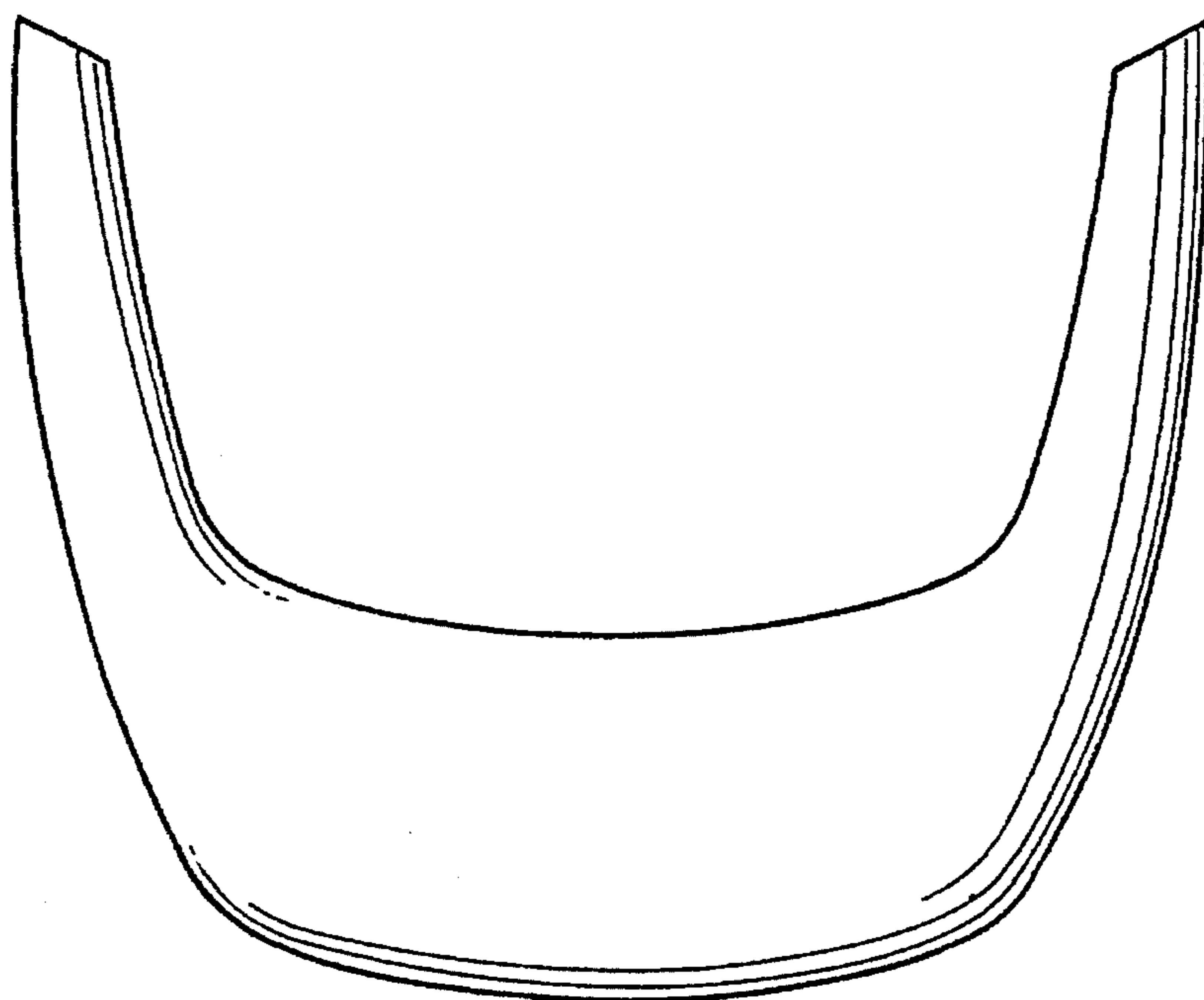

FIG. 9

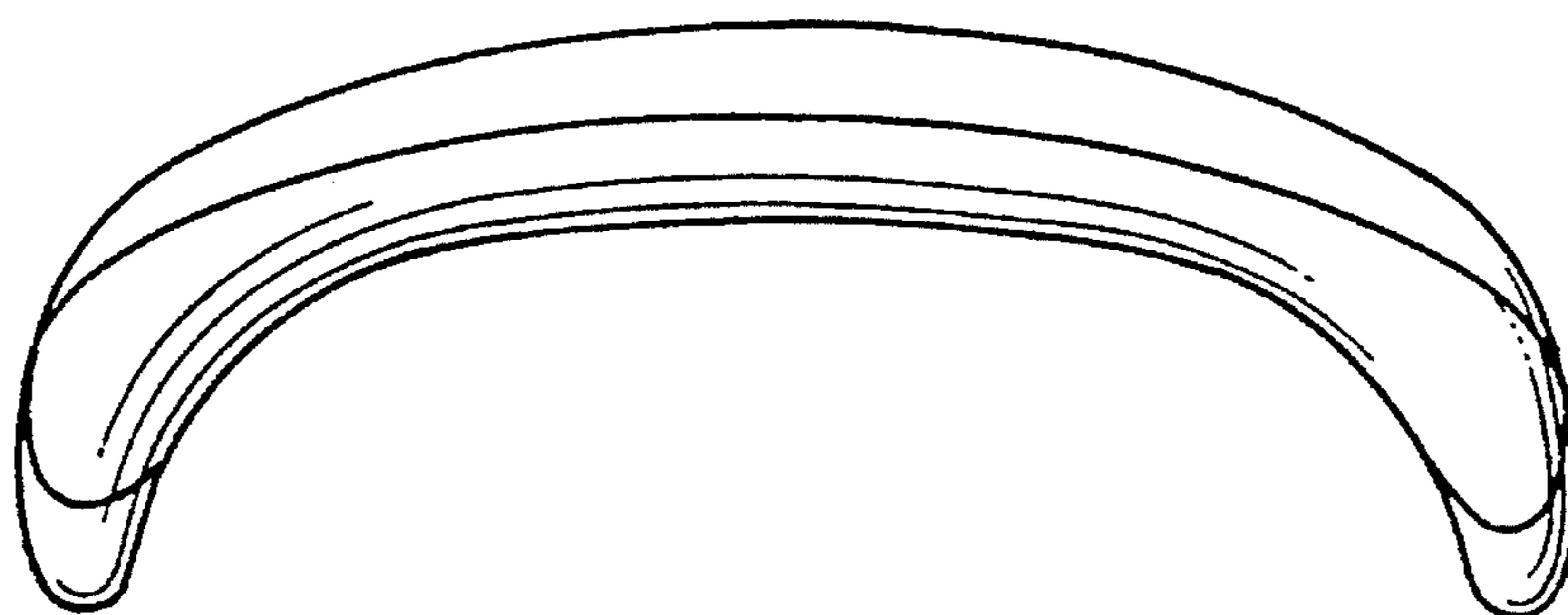

FIG. 10

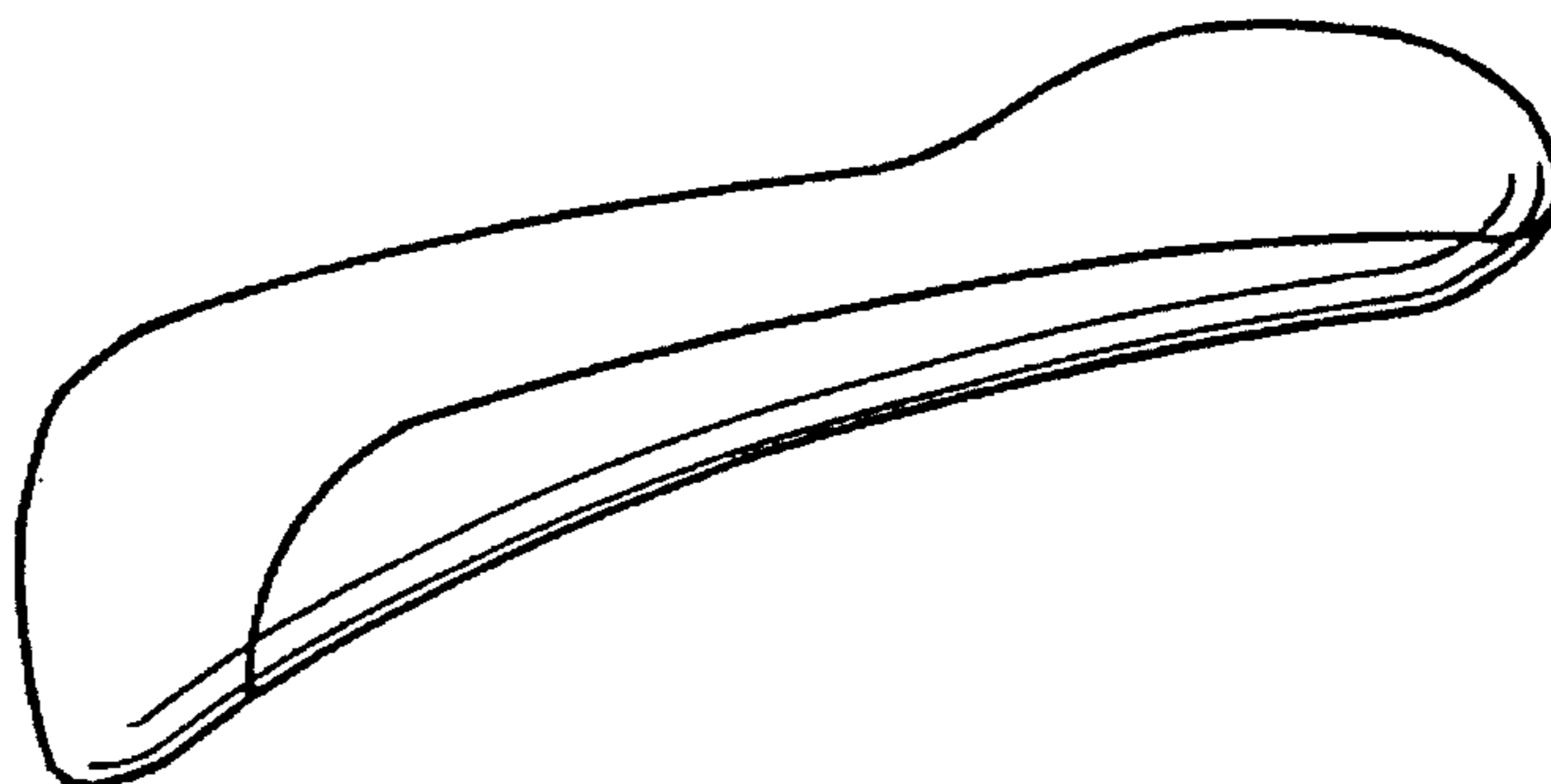

FIG. 11

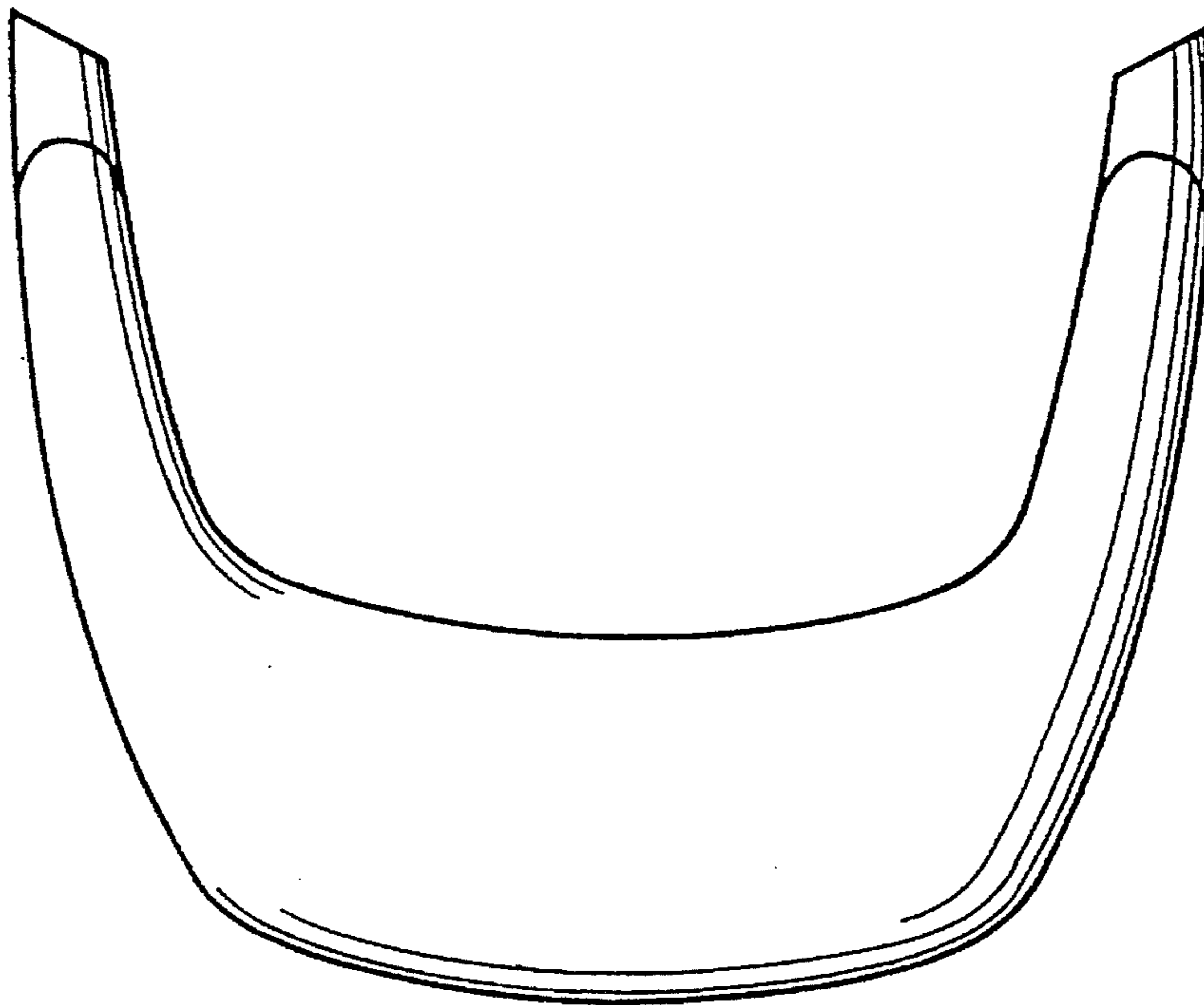

FIG. 12

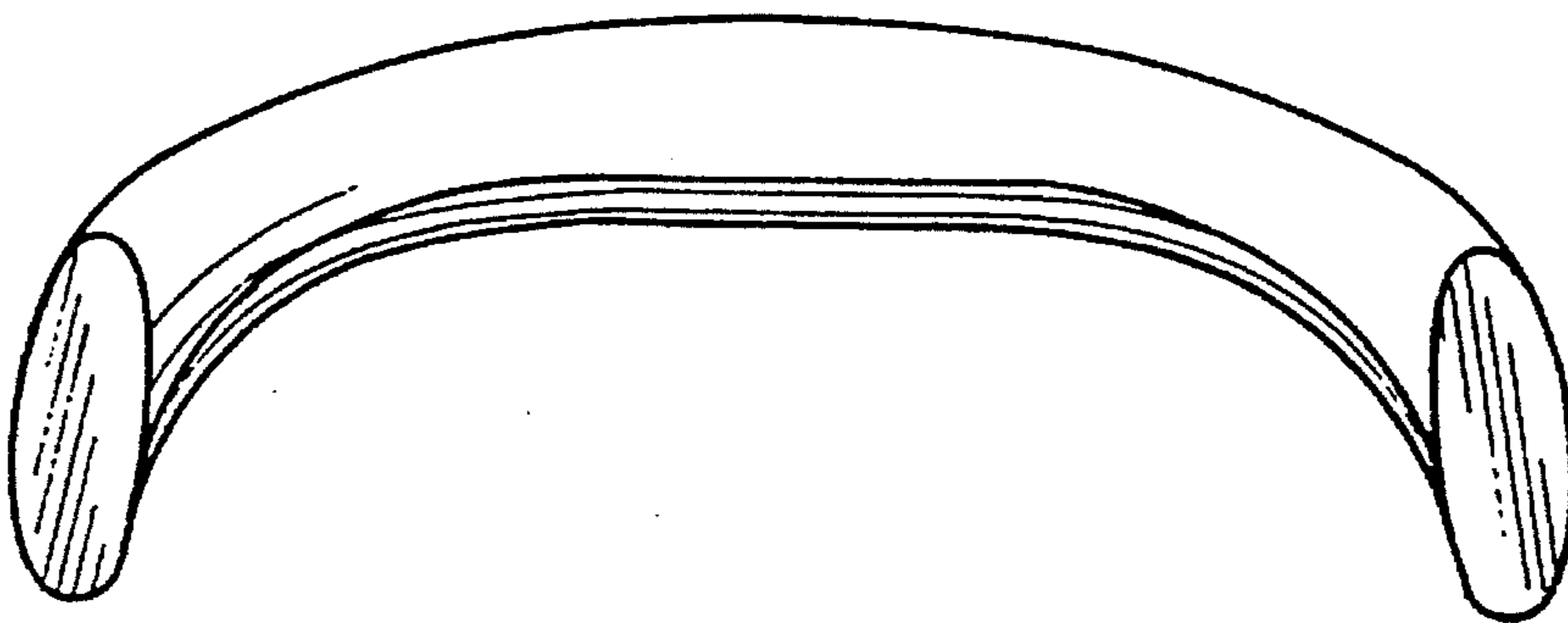

FIG. 13

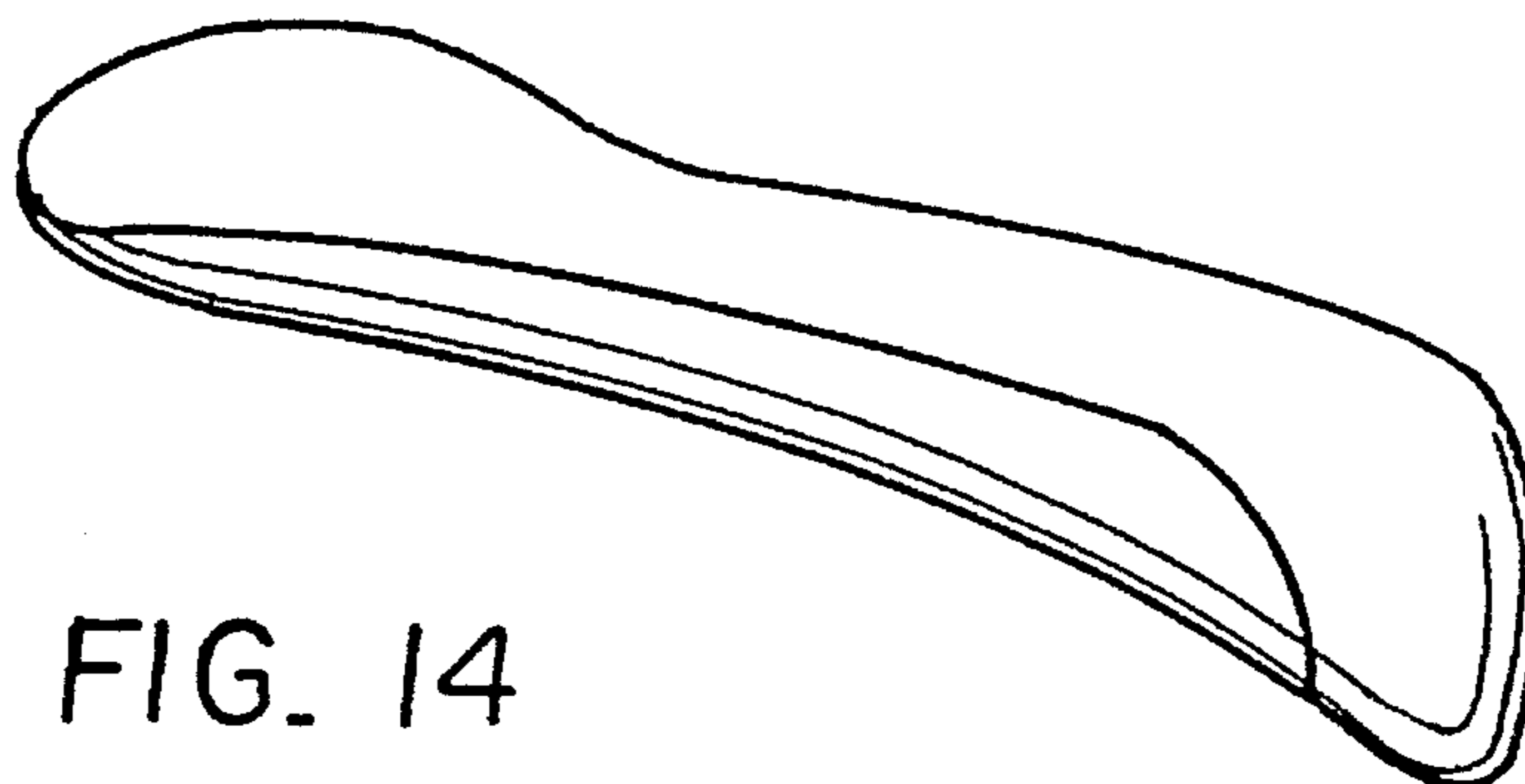

FIG. 14

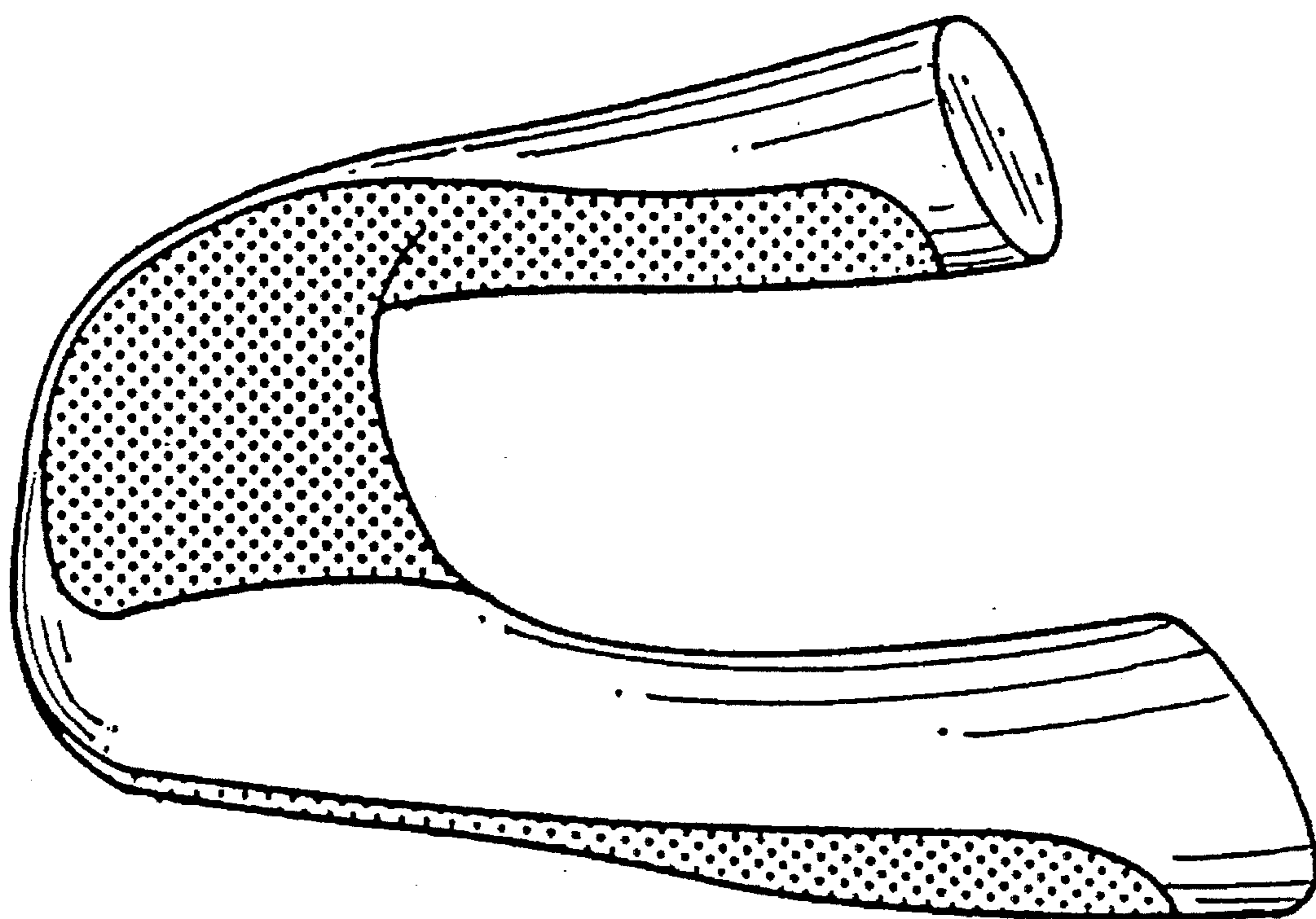

FIG. 15

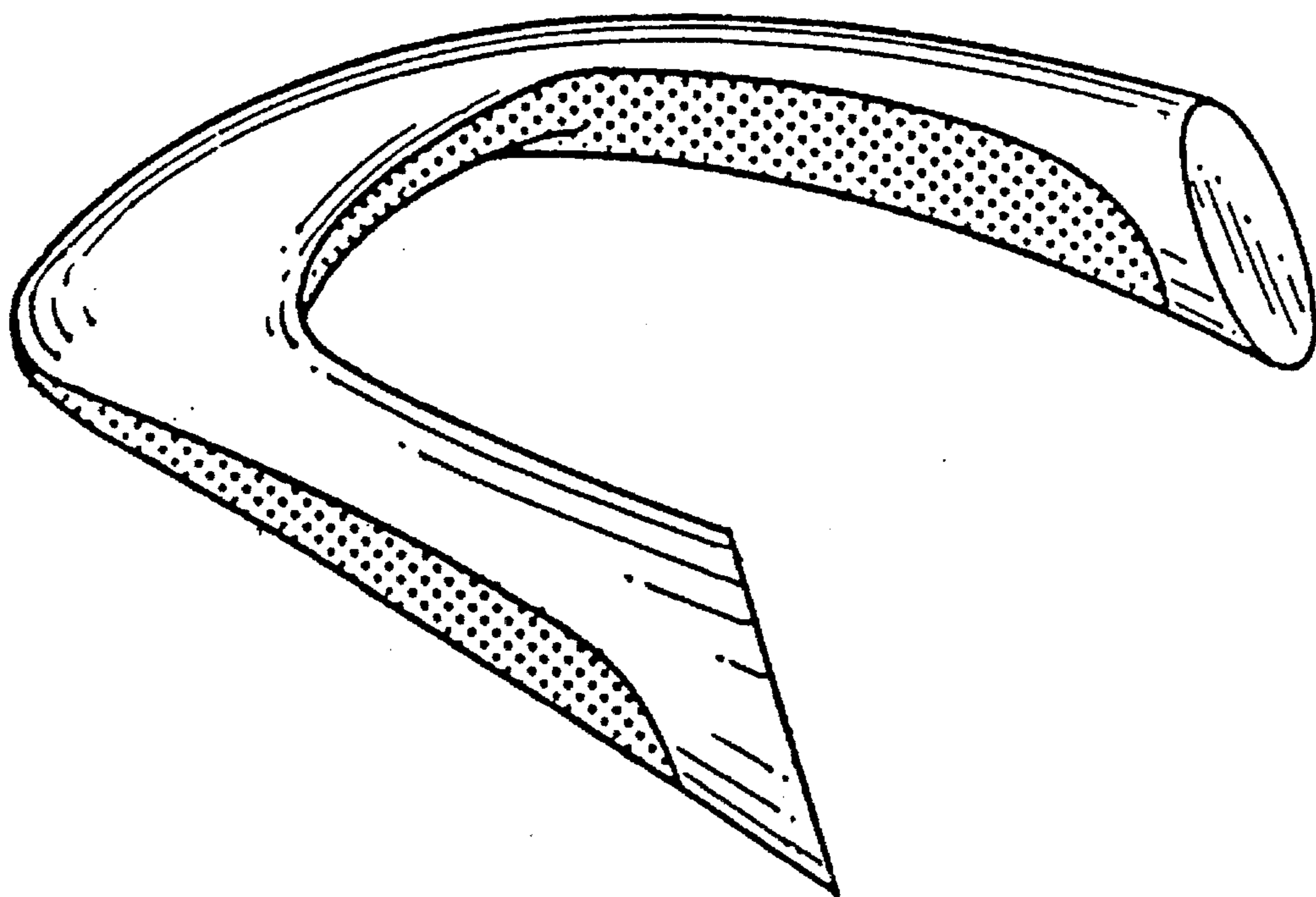

FIG. 16