



US00D367582S

United States Patent [19]

Desbarres

[11] **Patent Number:** **Des. 367,582**

[45] **Date of Patent:** ****Mar. 5, 1996**

[54] **COOKWARE PAN**

[75] Inventor: **Yves Desbarres**, Argenton sur Creuse, France

[73] Assignee: **Sitram**, Saint-Benoit-Du-Sault, France

[**] Term: **14 Years**

[21] Appl. No.: **25,472**

[22] Filed: **Jun. 8, 1994**

[30] Foreign Application Priority Data

Dec. 8, 1993 [FR] France 936430

[52] **U.S. Cl.** **D7/360**

[58] **Field of Search** D7/500, 543, 584, D7/354, 360, 361; 206/505, 507, 515; 99/324, 325, 339, 345, 425, 426, 445; 220/506, 513, 553, 555, 557, 641, 643, 912, DIG. 12; 126/373, 390

[56] References Cited

U.S. PATENT DOCUMENTS

D. 130,253 11/1941 Pearce D7/360

D. 226,816 5/1973 Press D7/361
D. 227,538 7/1973 Press D7/361
D. 353,303 12/1994 Davis D7/360 X
5,203,836 4/1993 Brazis et al. 206/507

Primary Examiner—Alan P. Douglas
Assistant Examiner—Caron D. Veynar
Attorney, Agent, or Firm—Sixbey, Friedman, Leedom & Ferguson; Gerald J. Ferguson, Jr.

[57] CLAIM

The ornamental design for a cookware pan, as shown and described.

DESCRIPTION

FIG. 1 is a front elevational view of a cookware pan showing my new design, the rear elevational view being a mirror image;
FIG. 2 is a side elevation view of my design;
FIG. 3 is an opposite side elevational view of FIG. 2;
FIG. 4 is a top plan view of my design;
FIG. 5 is a bottom plan view of my design; and,
FIG. 6 is a cross-sectional view of my design.

1 Claim, 3 Drawing Sheets

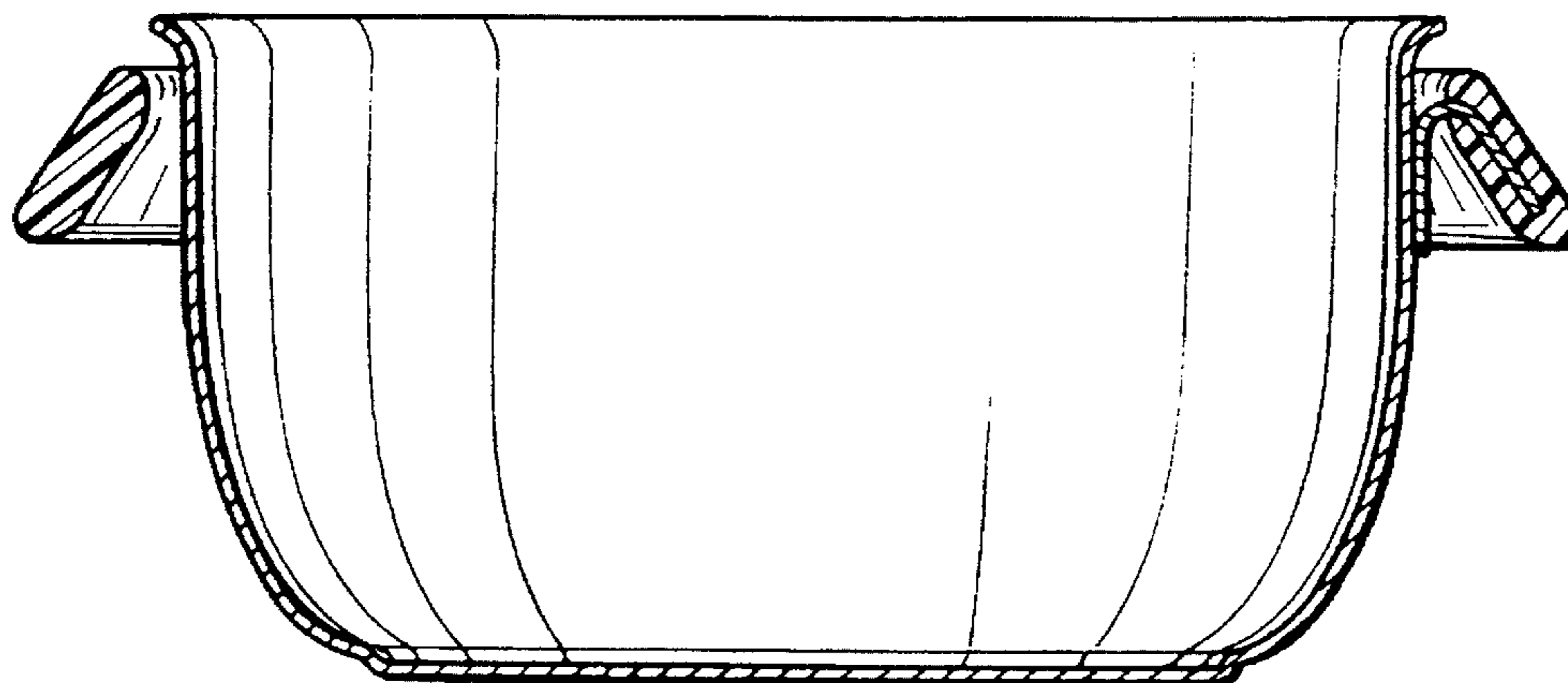
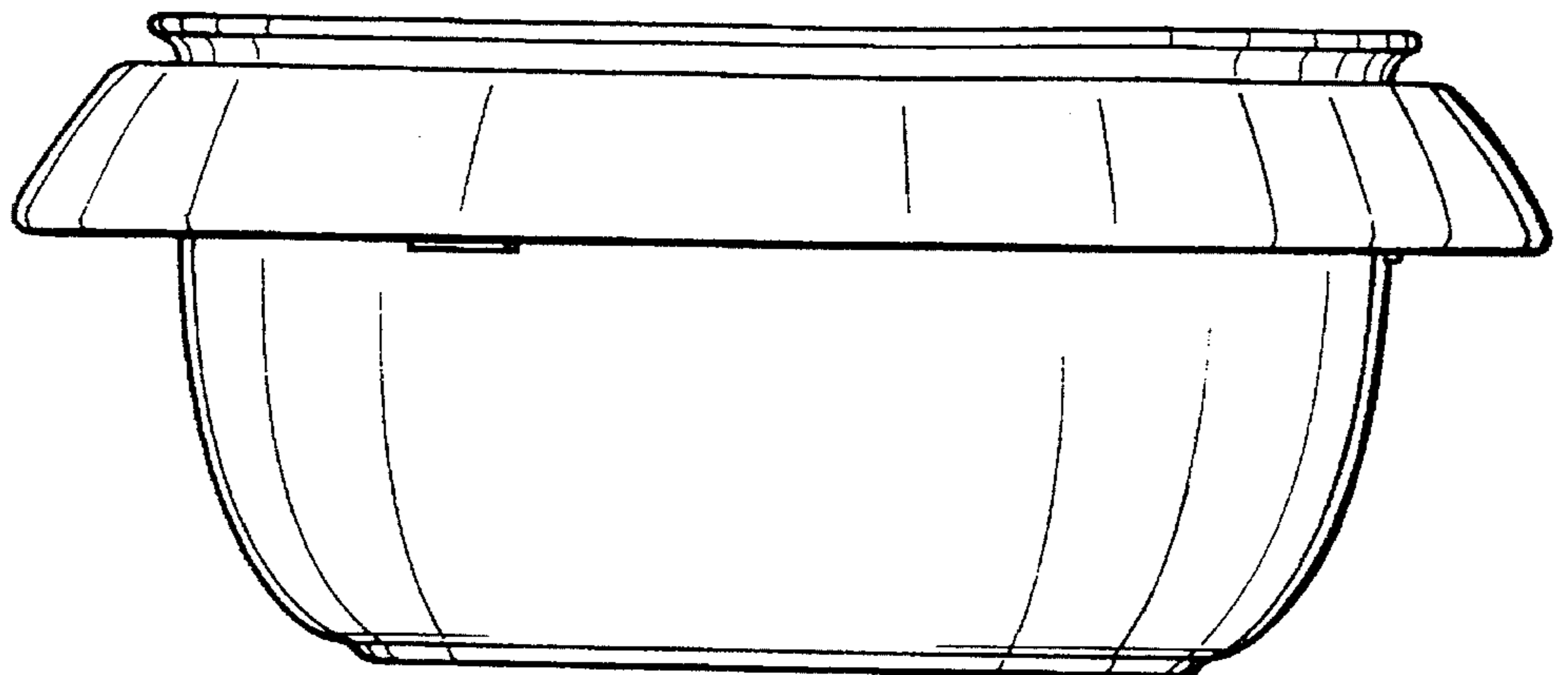

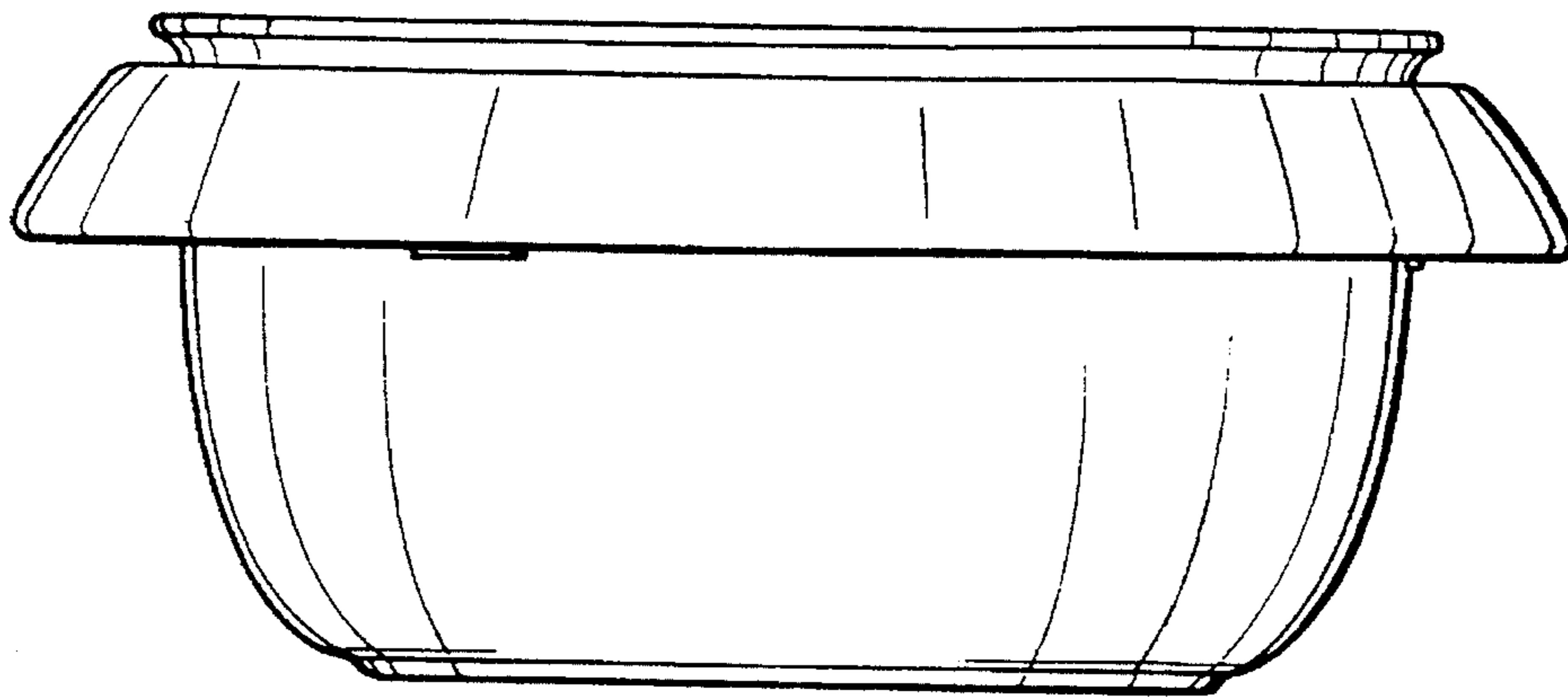

Fig. 1.

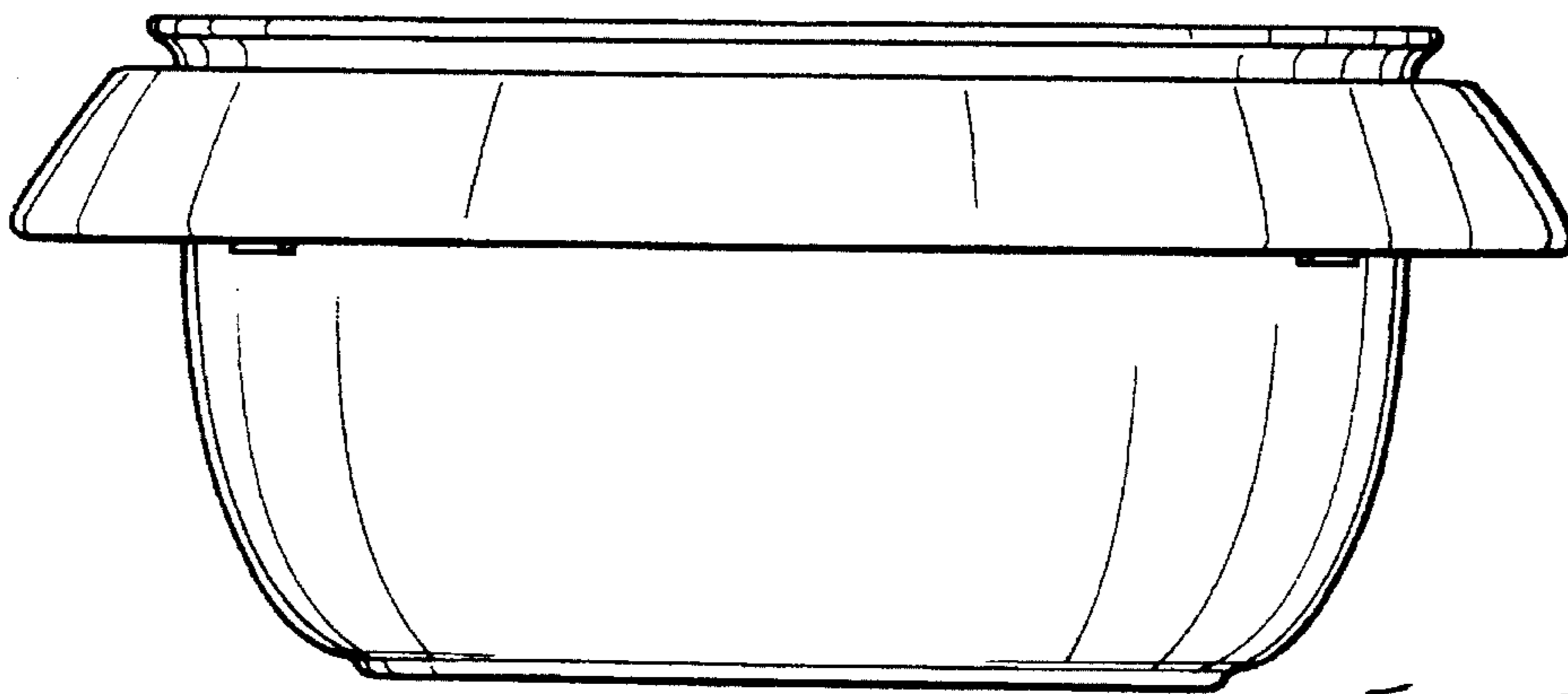

Fig. 2.

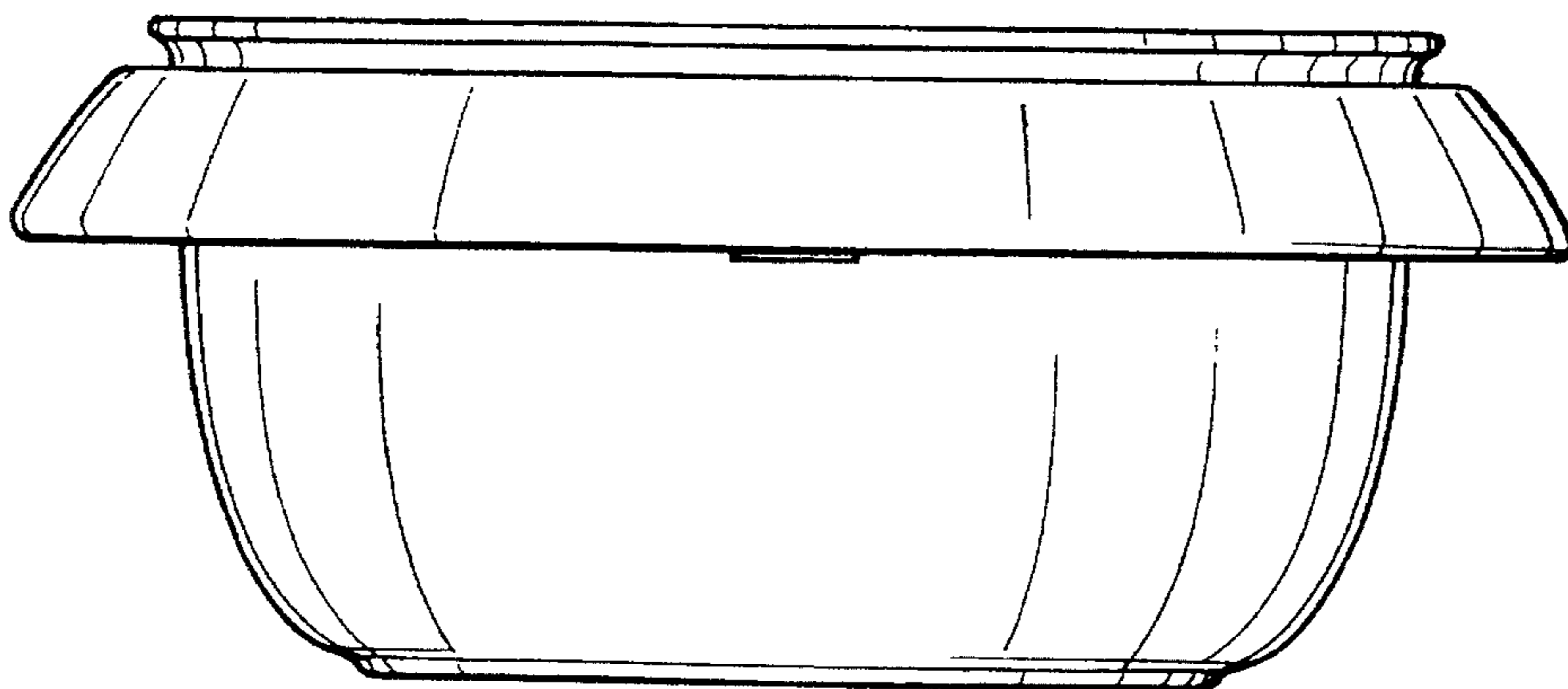

Fig. 3.

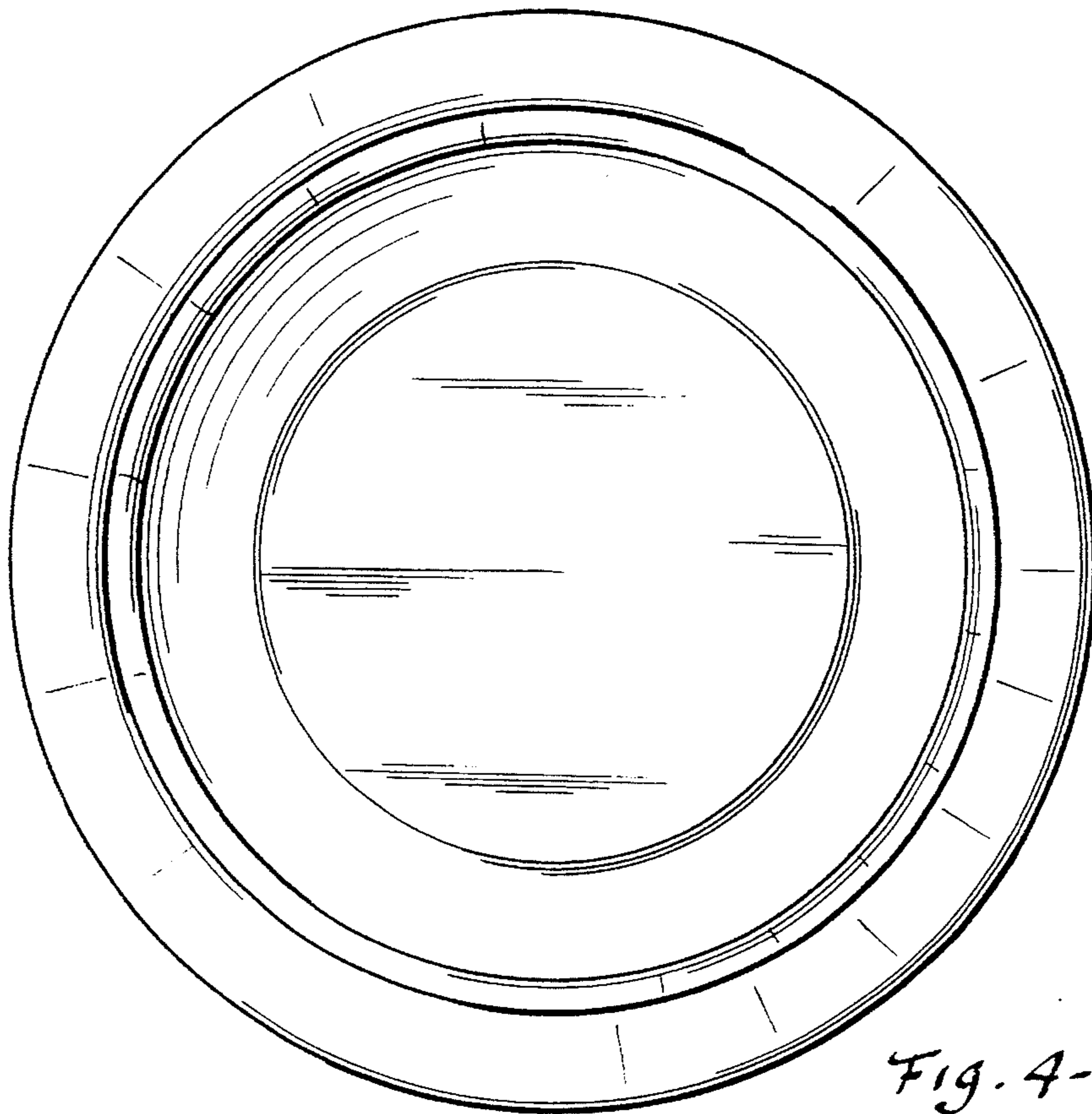

Fig. 4-

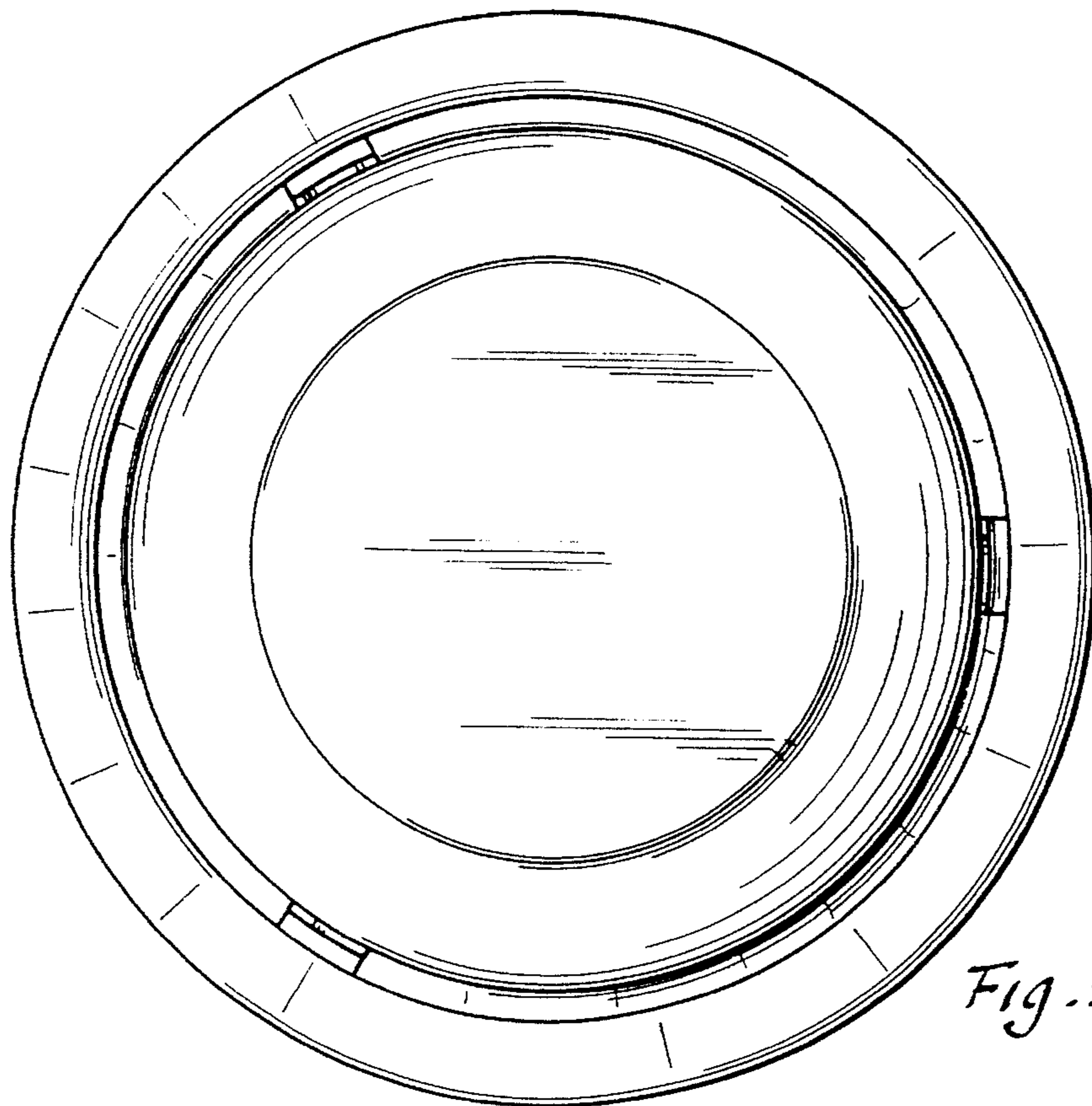

Fig. 5.

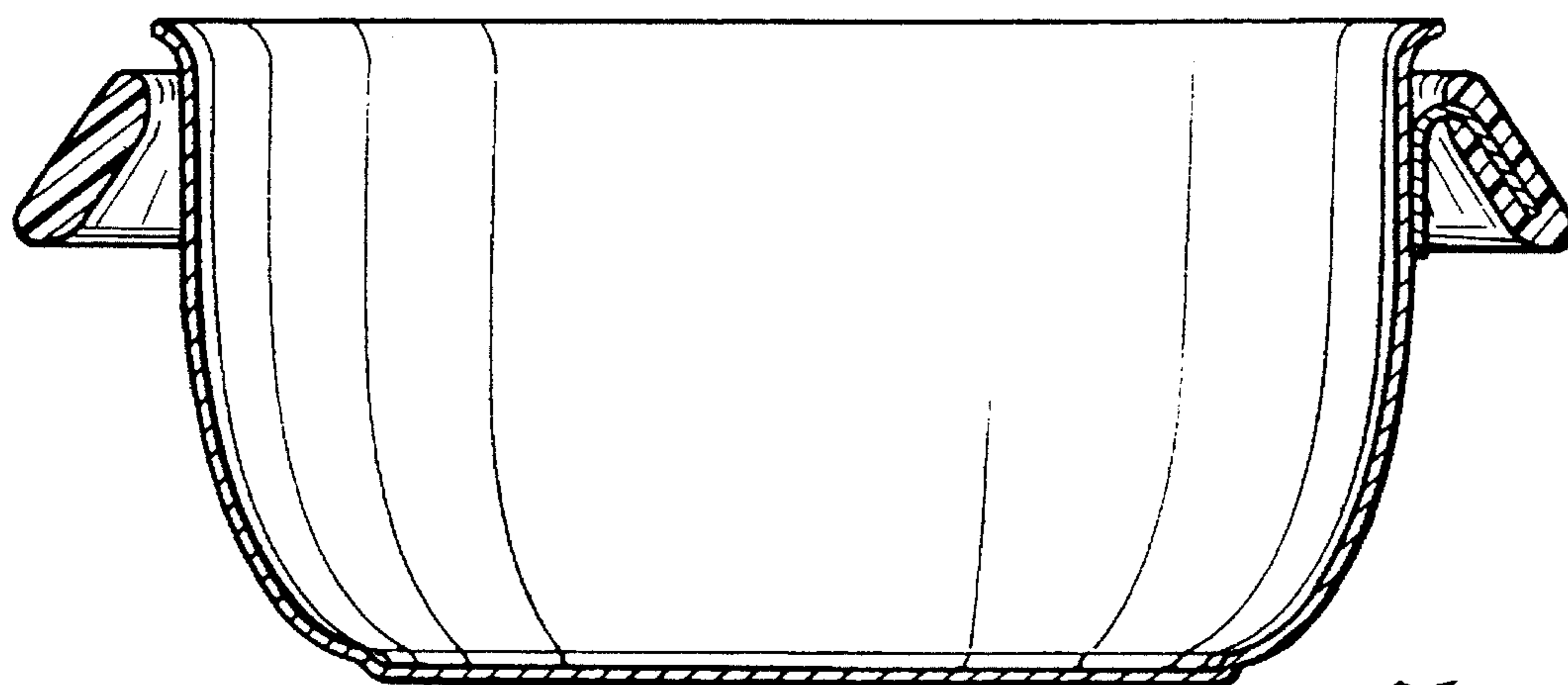

Fig. 6.