



US00D367443S

United States Patent [19]

Sacco et al.

[11] Patent Number: **Des. 367,443**

[45] Date of Patent: ****Feb. 27, 1996**

[54] TRUCK CAB BODY

D. 302,257 7/1989 Breitschwerdt et al. D12/96
D. 344,472 2/1994 Savio D12/96

[75] Inventors: **Bruno Sacco; Joseph Gallitzendoerfer**, both of Sindelfingen; **Peter Pfeiffer**, Boeblingen; **Gerhard Honer**, Wiel d. Stadt, all of Germany

Primary Examiner—A. Hugo Word
Assistant Examiner—M. Brown
Attorney, Agent, or Firm—Evenson McKeown Edwards & Lenahan

[73] Assignee: **Mercedes-Benz Aktiengesellschaft**, Stuttgart, Germany

[57] **CLAIM**

[**] Term: **14 Years**

The ornamental design for a truck cab body, as shown and described.

[21] Appl. No.: **17,268**

DESCRIPTION

[22] Filed: **Jan. 10, 1994**

FIG. 1 is rear view of the truck cab body according to my novel design;
FIG. 2 is a front view of the truck cab body according to my novel design;
FIG. 3 is a right side view of the truck cab body according to my novel design;
FIG. 4 is a left side view of the truck cab body according to my novel design;
FIG. 5 is a top view of the truck cab body according to my novel design; and,
FIG. 6 is a perspective view thereof.

[30] **Foreign Application Priority Data**

Jul. 9, 1993 [DE] Germany M9305296.0

[52] U.S. Cl. **D12/96**

[58] Field of Search D12/96, 97; 296/190; 180/89.12, 89.13, 89.14, 89.16

[56] **References Cited**

U.S. PATENT DOCUMENTS

D. 286,031 10/1986 Breitschwerdt et al. D12/96

1 Claim, 4 Drawing Sheets

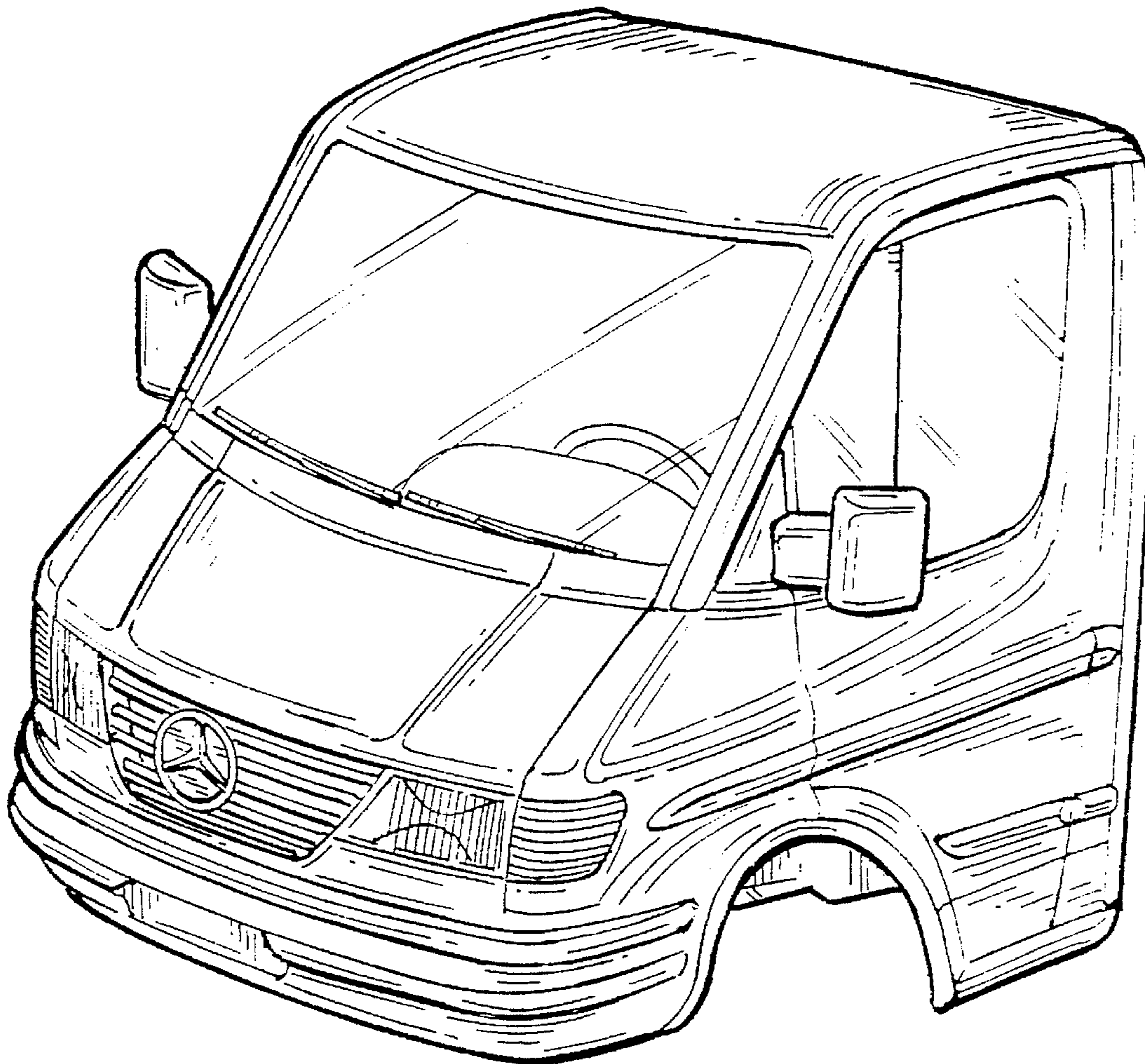

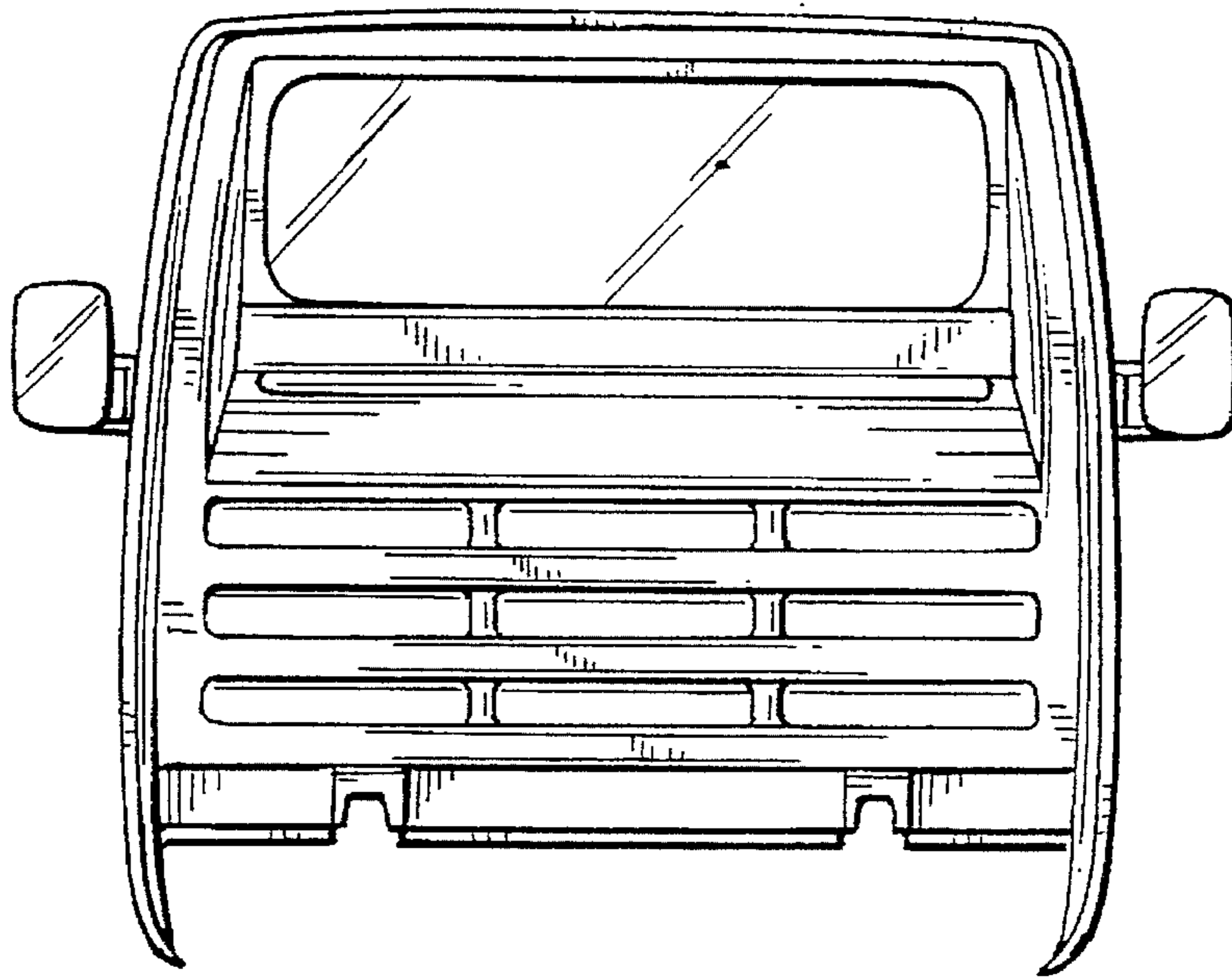

FIG. 1

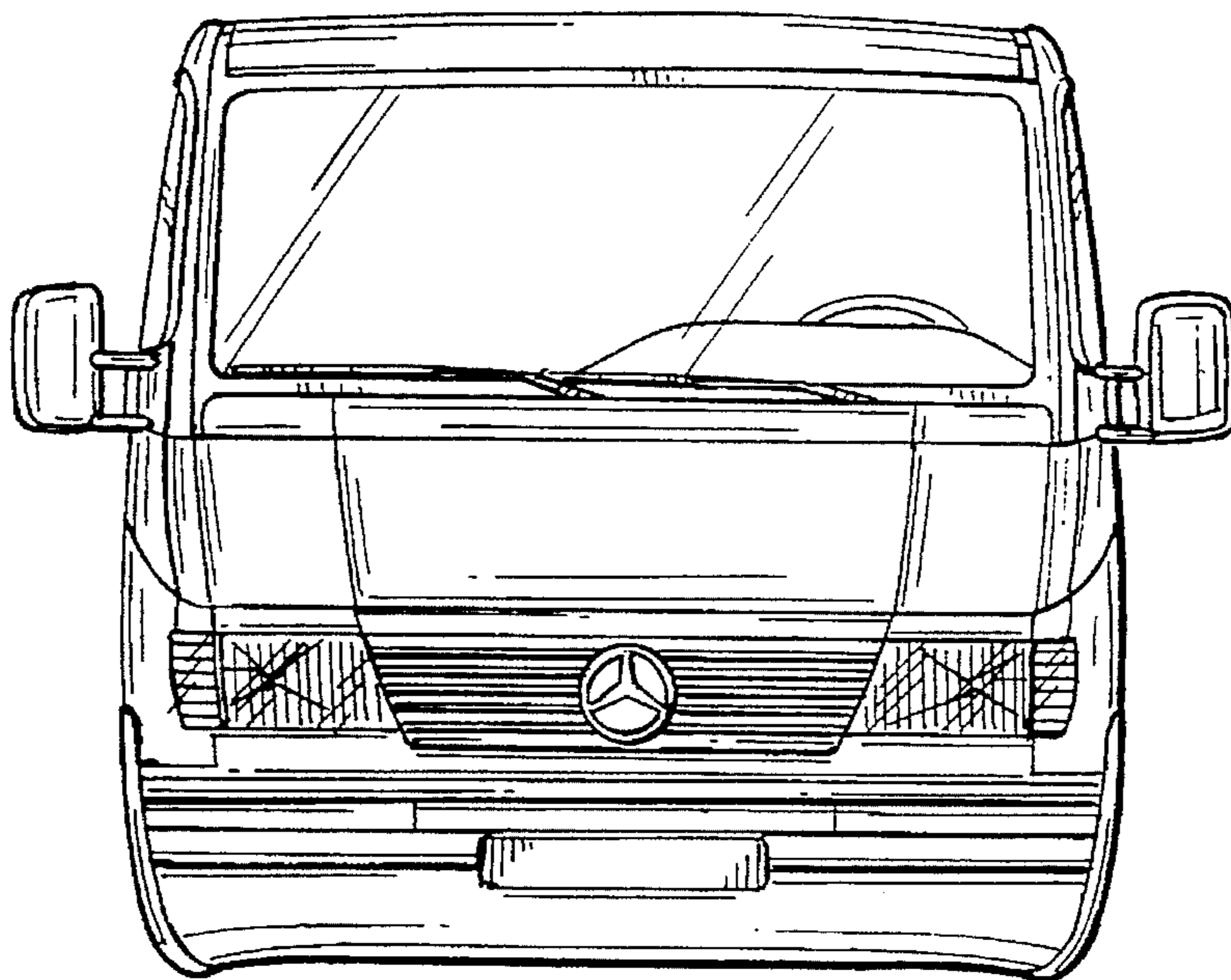

FIG. 2

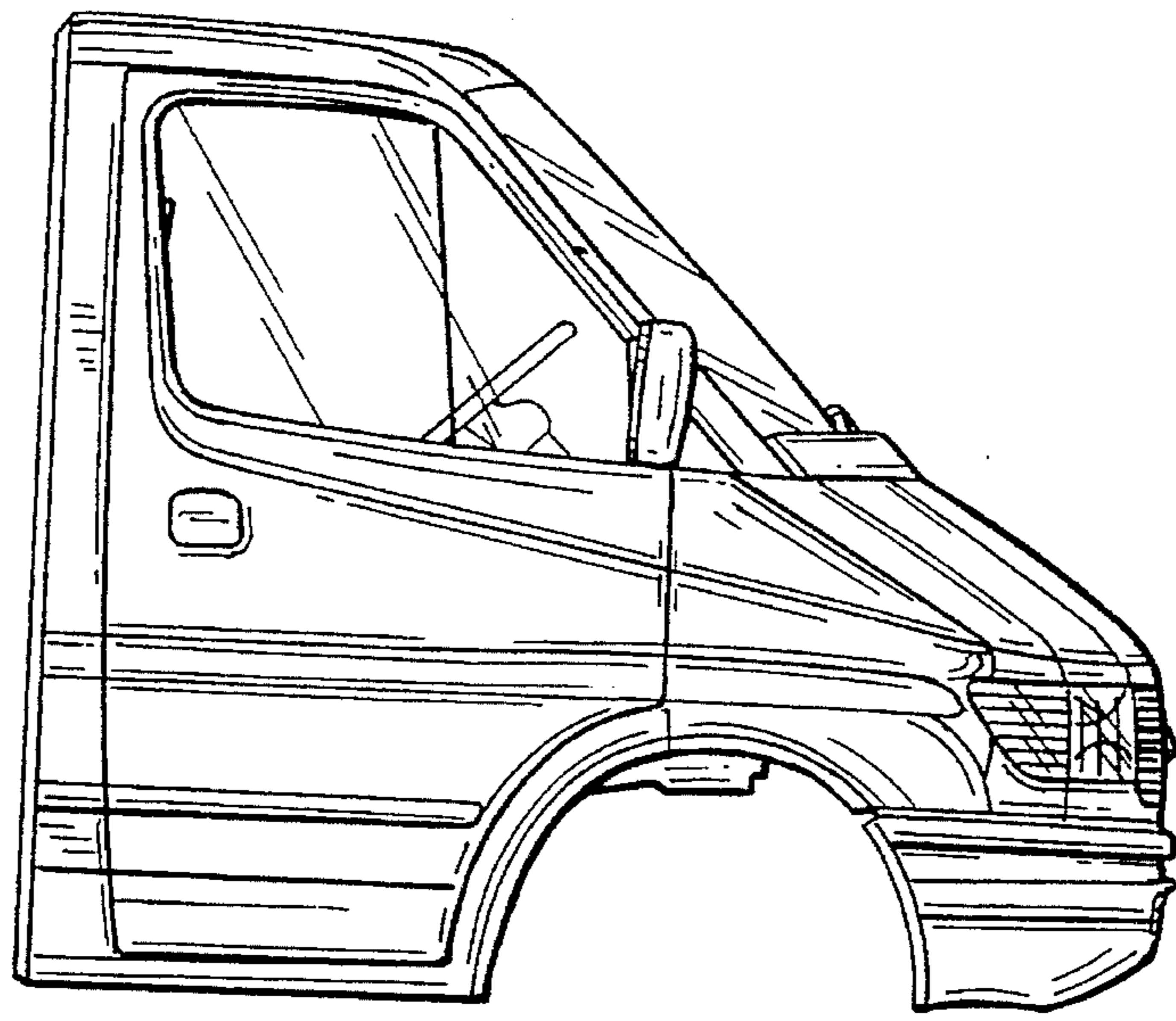

FIG. 3

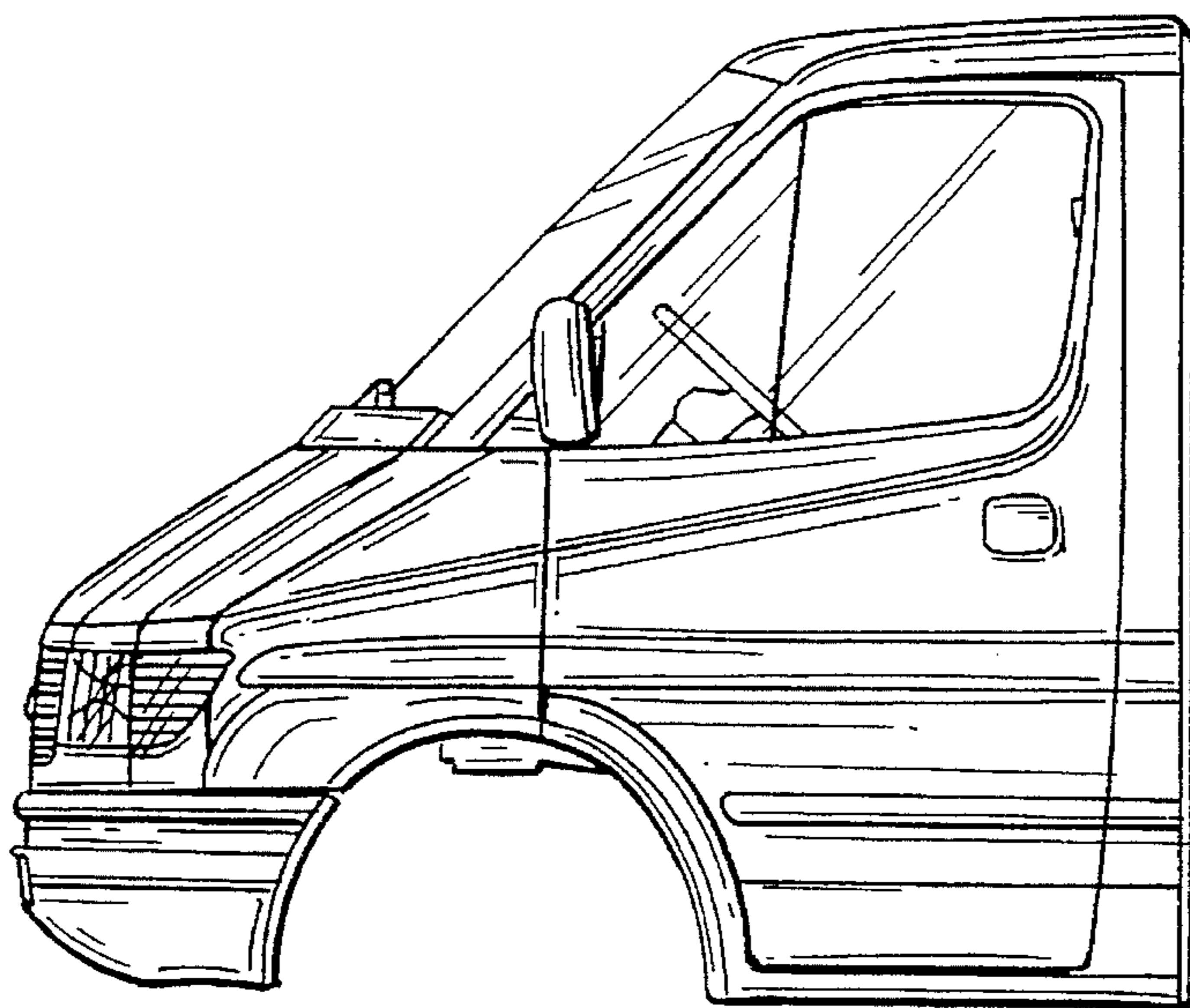

FIG. 4

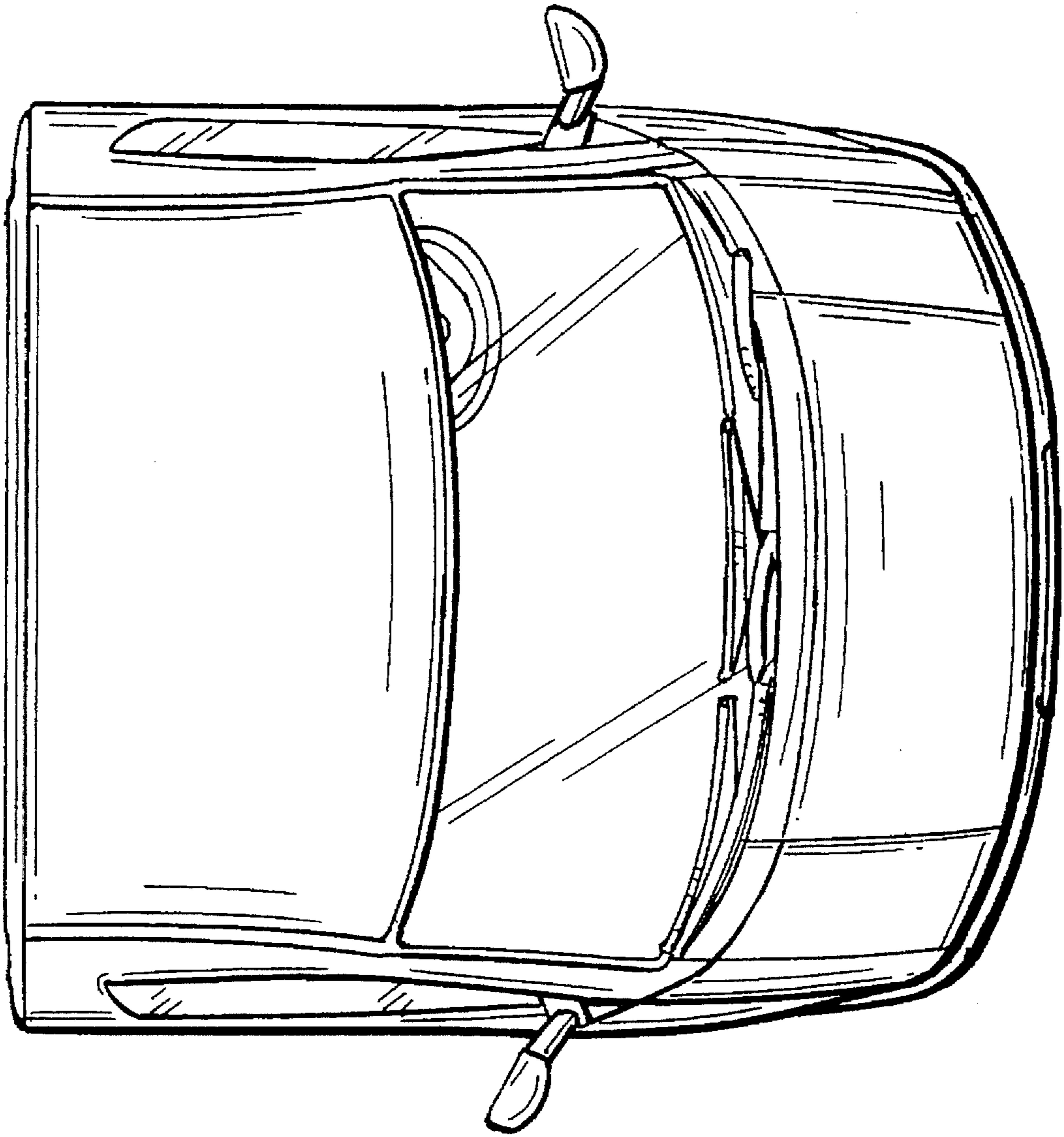

FIG. 5

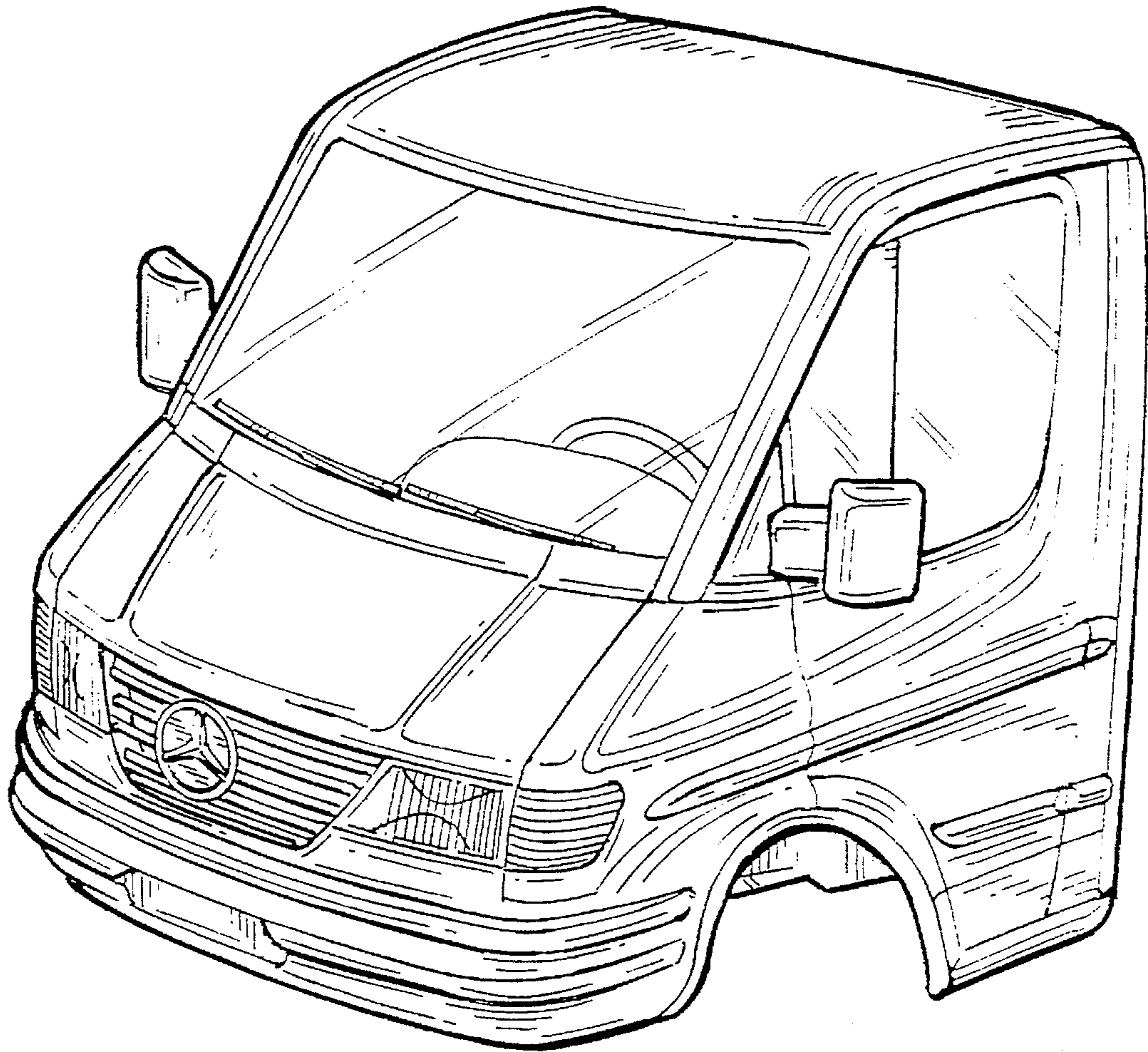

FIG. 6