



US00D367355S

United States Patent [19]

Fleming, Jr.

[11] Patent Number: **Des. 367,355**

[45] Date of Patent: ****Feb. 27, 1996**

[54] **MONOGRAM CASE KIT FOR A PAGER**

[76] Inventor: **Ollie F. Fleming, Jr.**, 2143 General Cleburne, Baton Rouge, La. 70810

[**] Term: **14 Years**

[21] Appl. No.: **24,816**

[22] Filed: **Jun. 21, 1994**

[52] U.S. Cl. **D3/218**

[58] Field of Search D3/218, 215, 225, D3/230, 243; 206/305, 387, 316.1, 316.2; 224/236, 252, 253, 250, 151, 901, 269, 255, 240, 239, 199, 242, 904, 42.46, 268

[56] **References Cited**

U.S. PATENT DOCUMENTS

- D. 297,248 8/1988 Barr .
- D. 324,955 3/1992 Coffey et al. .
- D. 329,750 9/1992 Gilmore et al. .
- D. 329,926 9/1992 Winder D3/215 X
- D. 352,602 11/1994 Wendell D3/215 X
- 2,920,671 1/1960 Siris et al. .
- 3,091,378 5/1963 O'Dwyer .
- 3,550,663 12/1970 Johnston .
- 4,112,991 9/1978 Barbaresi .
- 4,896,805 1/1990 Klaczak et al. .
- 4,901,852 2/1990 King .

- 4,903,745 2/1990 Roman .
- 4,948,022 8/1990 Van Dyke 224/901 X
- 5,261,122 11/1993 Otsuki et al. 224/252 X

FOREIGN PATENT DOCUMENTS

- 812953 9/1951 Germany .

Primary Examiner—Louis S. Zarfaz
Assistant Examiner—Catherine R. Oliver
Attorney, Agent, or Firm—Richard C. Litman

[57] **CLAIM**

The ornamental design for a monogram case kit for a pager, as shown and described.

DESCRIPTION

FIG. 1 is an exploded front perspective view of a monogram case kit for a pager showing my new design; FIG. 2 is an exploded front elevational view thereof; FIG. 3 is an exploded rear elevational view thereof; FIG. 4 is an exploded left side elevational view with the right side being a mirror image thereof; FIG. 5 is a top view of the exploded elements thereof; and, FIG. 6 is a bottom view of the exploded elements thereof. The broken line showing of legible matter in FIGS. 1 and 2 is for illustrative purposes only and forms no part of the claimed design.

1 Claim, 2 Drawing Sheets

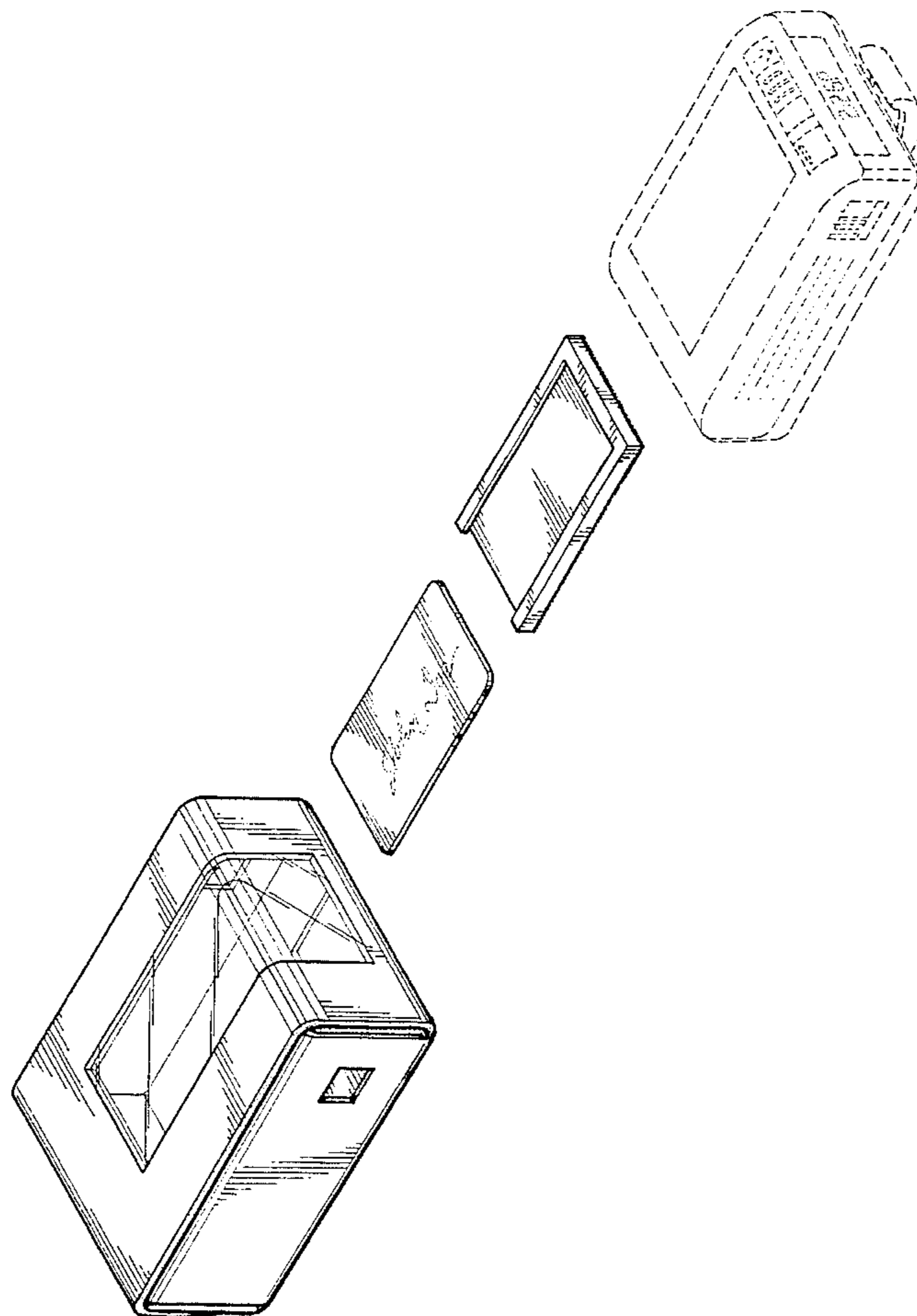

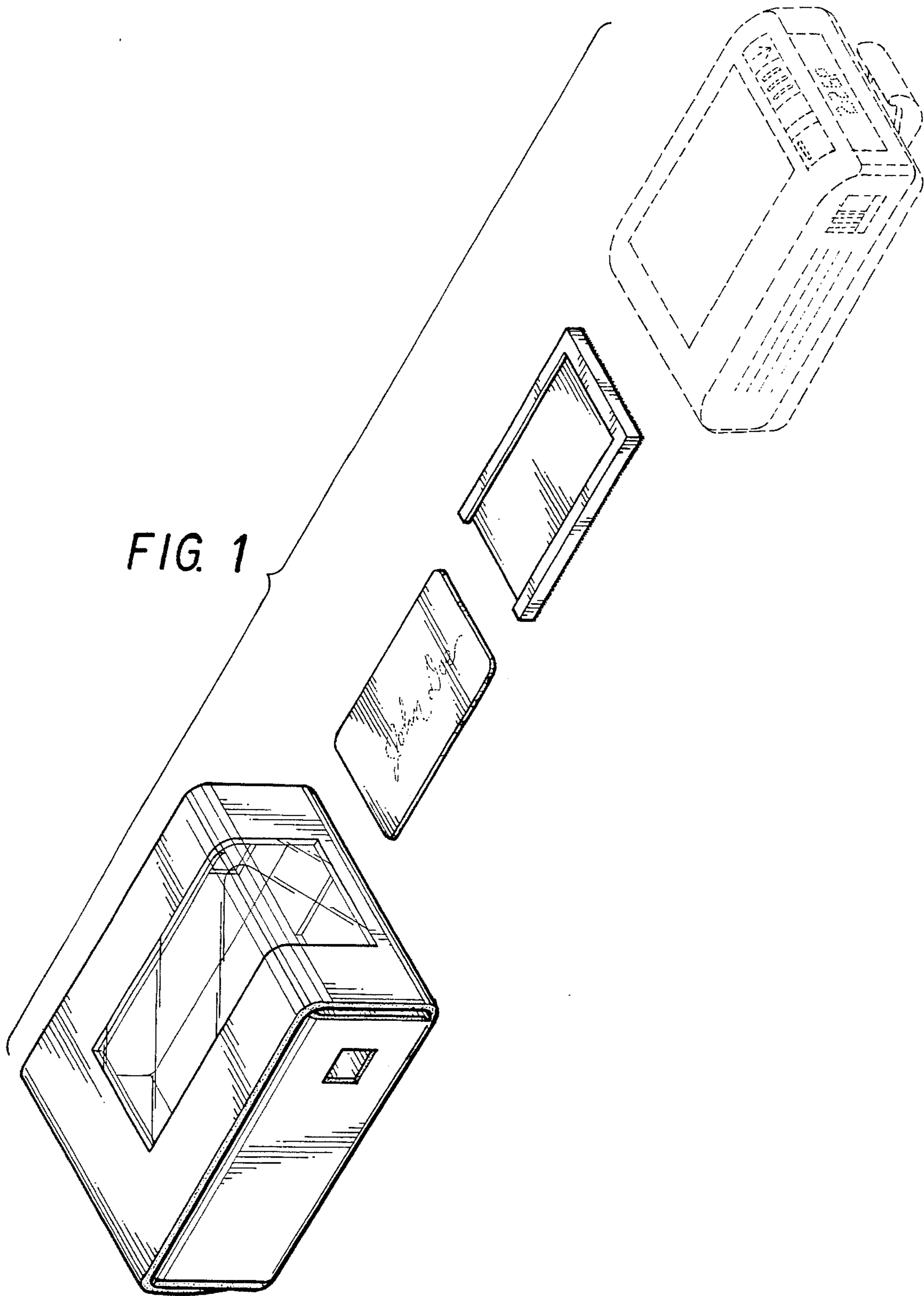

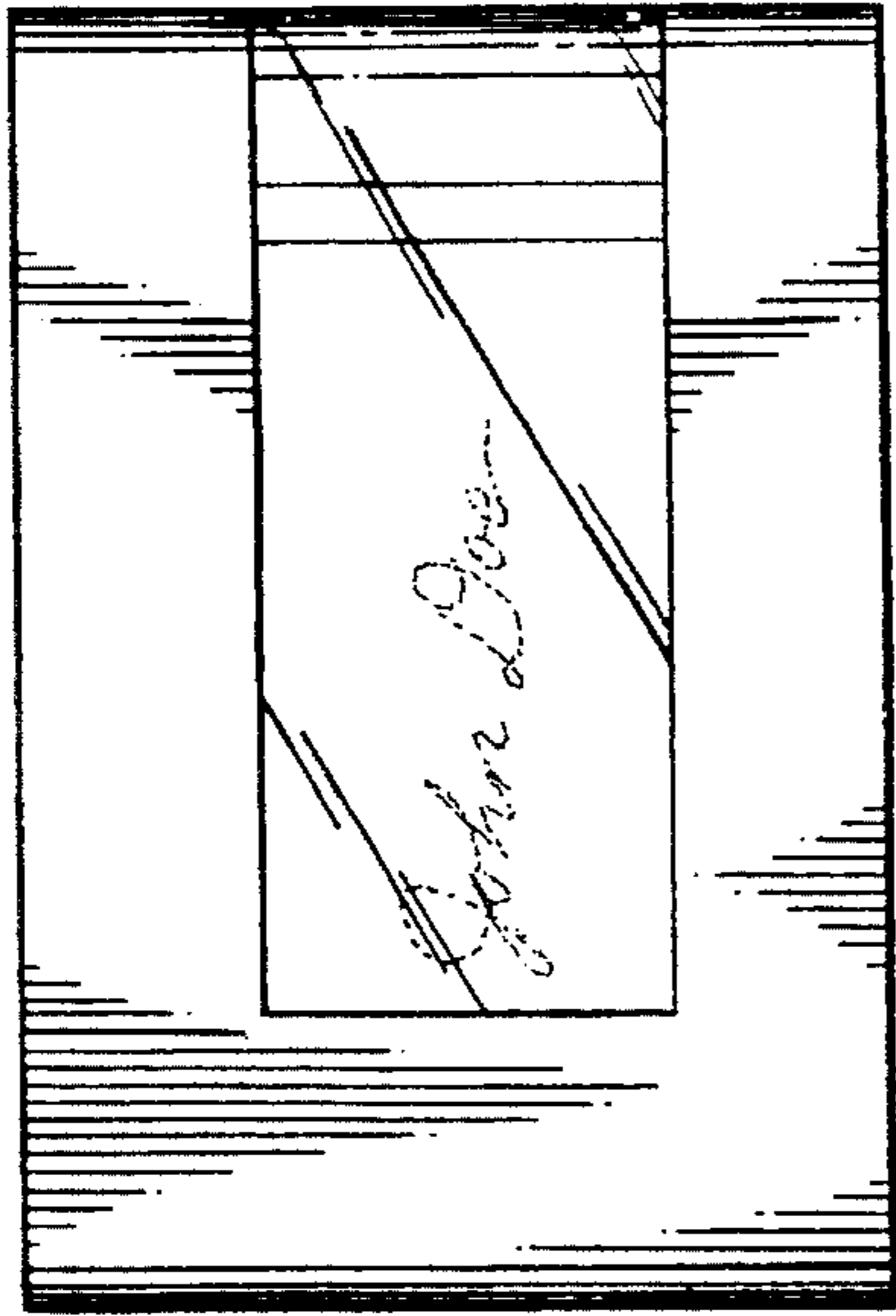

FIG. 2

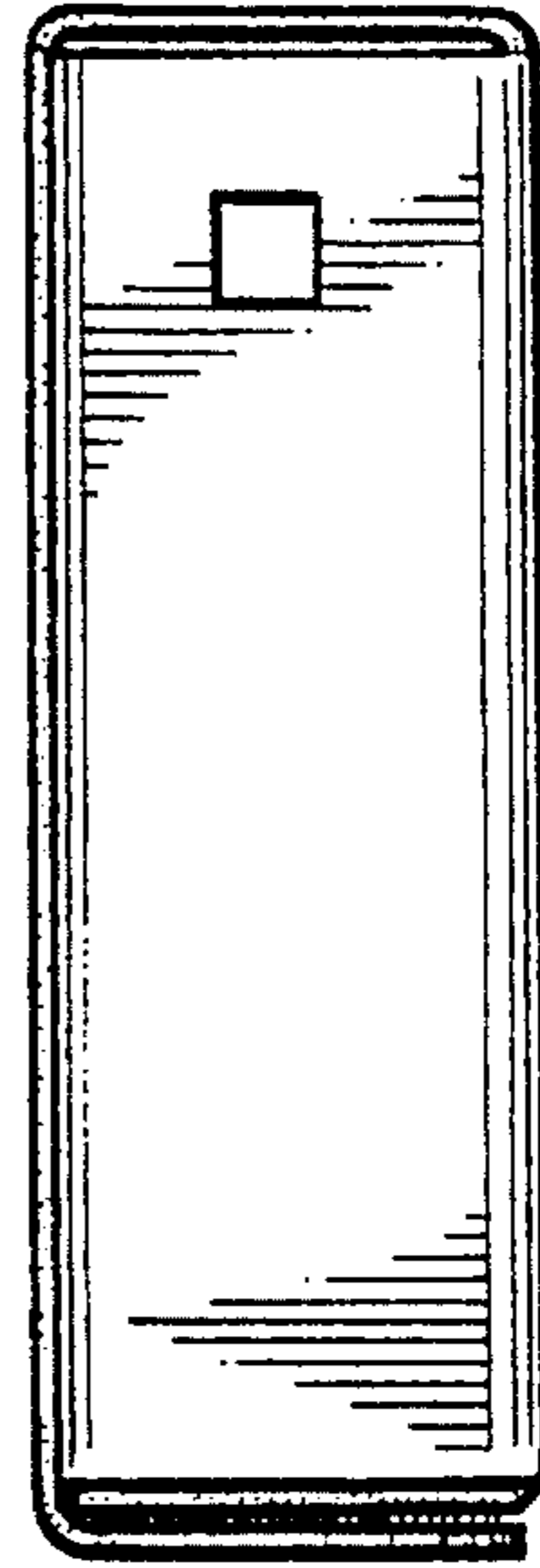

FIG. 4

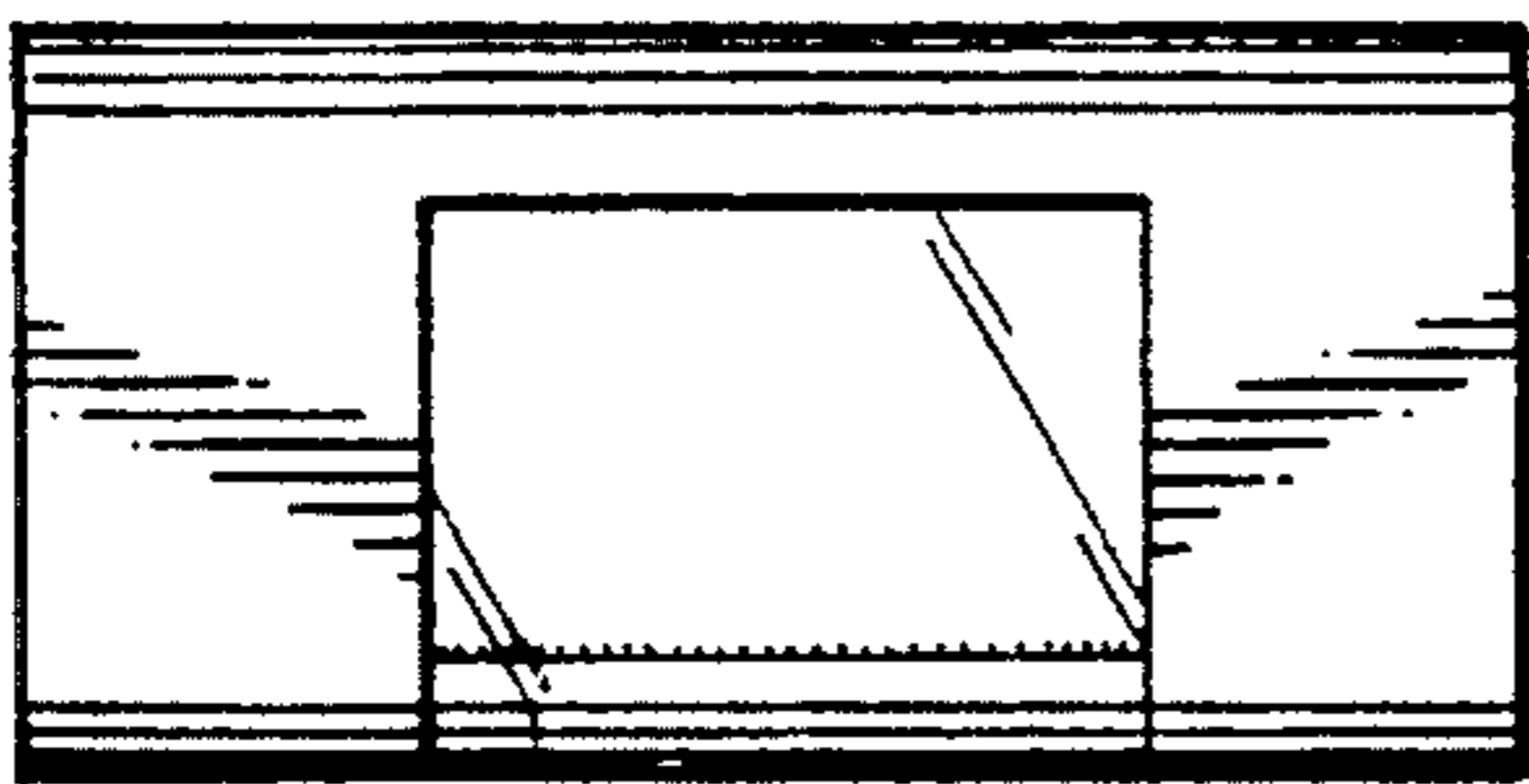

FIG. 5

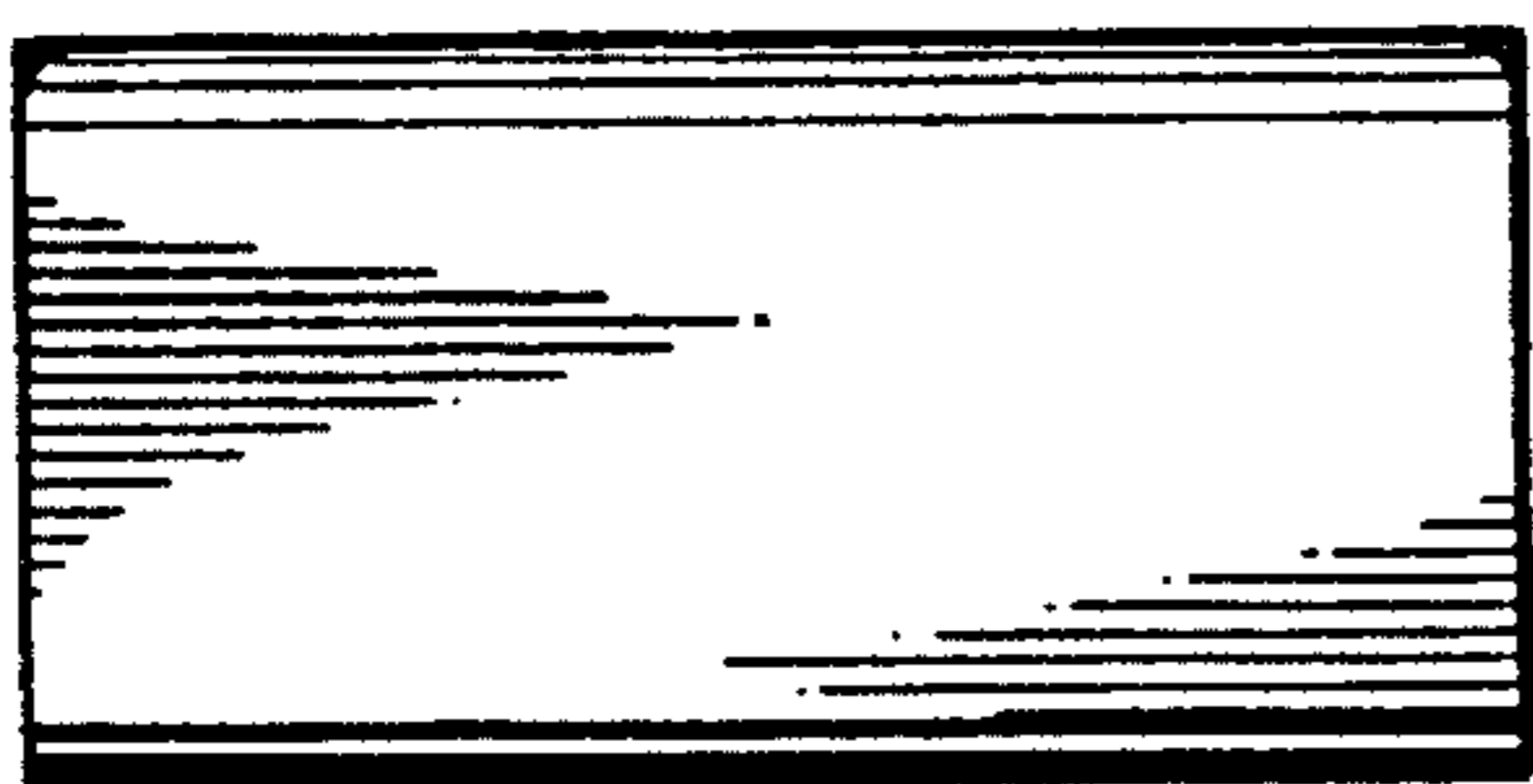

FIG. 6

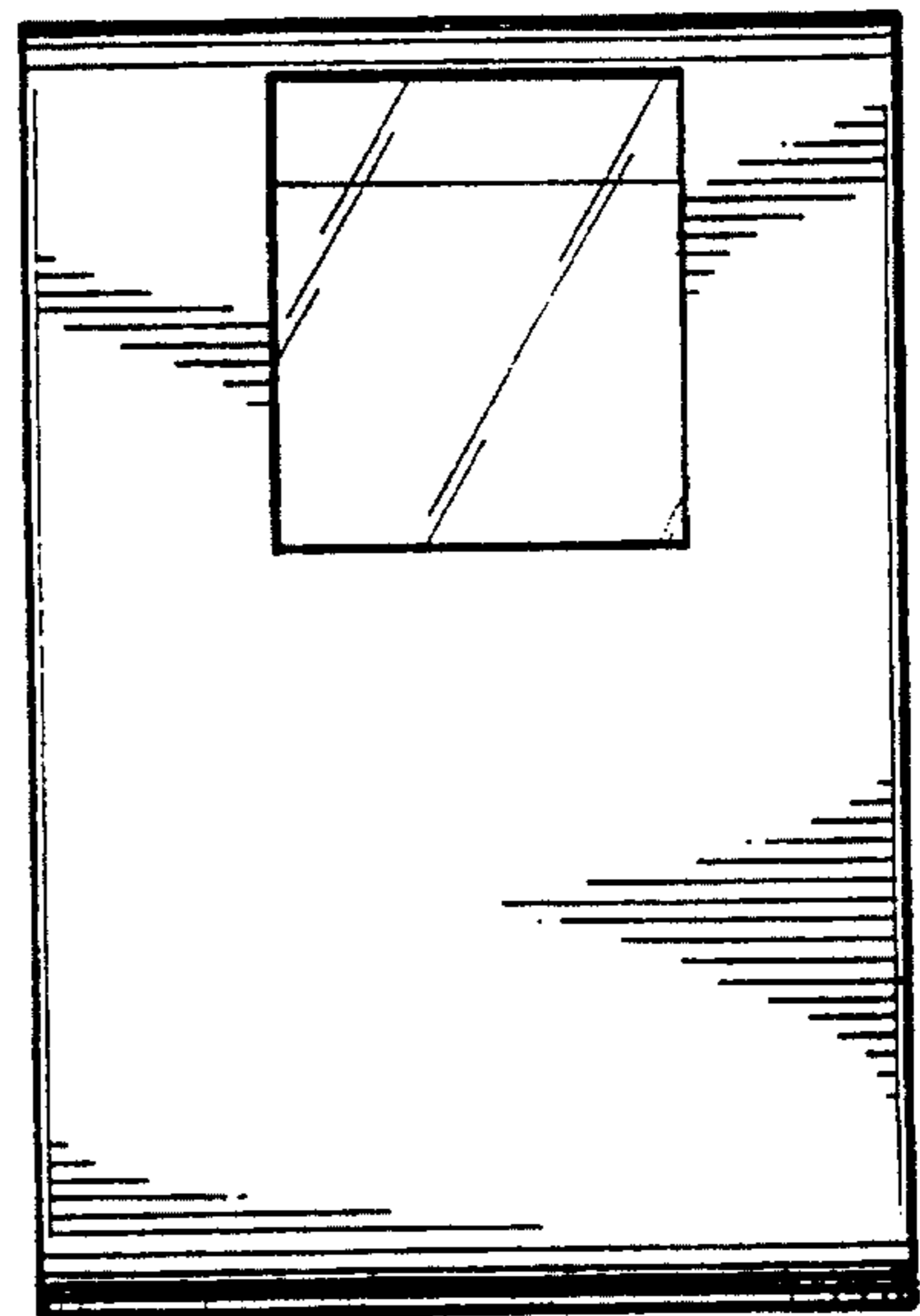

FIG. 3