



US00D367345S

United States Patent [19]

[11] Patent Number: **Des. 367,345**

Swenor

[45] Date of Patent: ****Feb. 20, 1996**

[54] **COMBINATION GARBAGE BAG DISPENSER AND SUPPORT**

4,723,743	2/1988	Jenkins	220/908 X
4,915,248	4/1990	Chap	220/908 X
4,925,056	5/1990	Mc Coig .	
5,018,637	5/1991	Miller .	

[76] Inventor: **Leonard J. Swenor**, 308 Darlene Dr., Waukesha, Wis. 53186

[**] Term: **14 Years**

OTHER PUBLICATIONS

Hold Everything (Mar. 1992) p. 17, Magazine Rack.

[21] Appl. No.: **17,113**

Primary Examiner—Brian N. Vinson

[22] Filed: **Jan. 5, 1994**

[57] CLAIM

[52] U.S. Cl. **D34/6; D6/515**

The ornamental design for the combination garbage bag dispenser and support, as shown and described.

[58] Field of Search D6/515; D34/1, D34/5-6; 220/908, 694, 737; 221/33, 66, 282, 284

DESCRIPTION

[56] References Cited

FIG. 1 is a front elevational view of the combination garbage bag dispenser and support showing my new design; FIG. 2 is a rear elevational view thereof; FIG. 3 is a left side elevational view thereof; FIG. 4 is a right side elevational view thereof; FIG. 5 is a top plan view thereof; FIG. 6 is a bottom plan view thereof; and, FIG. 7 is a perspective view thereof.

U.S. PATENT DOCUMENTS

D. 308,272	5/1990	Koepsell	D34/6
D. 311,801	10/1990	Kullenberg	D34/5
D. 327,014	6/1992	Heller et al.	D34/6 X
D. 358,325	5/1995	McNaughton	D34/6 X
4,558,800	12/1985	Isgar et al. .	
4,697,771	10/1987	Majors .	
4,711,367	12/1987	Albertson .	

1 Claim, 4 Drawing Sheets

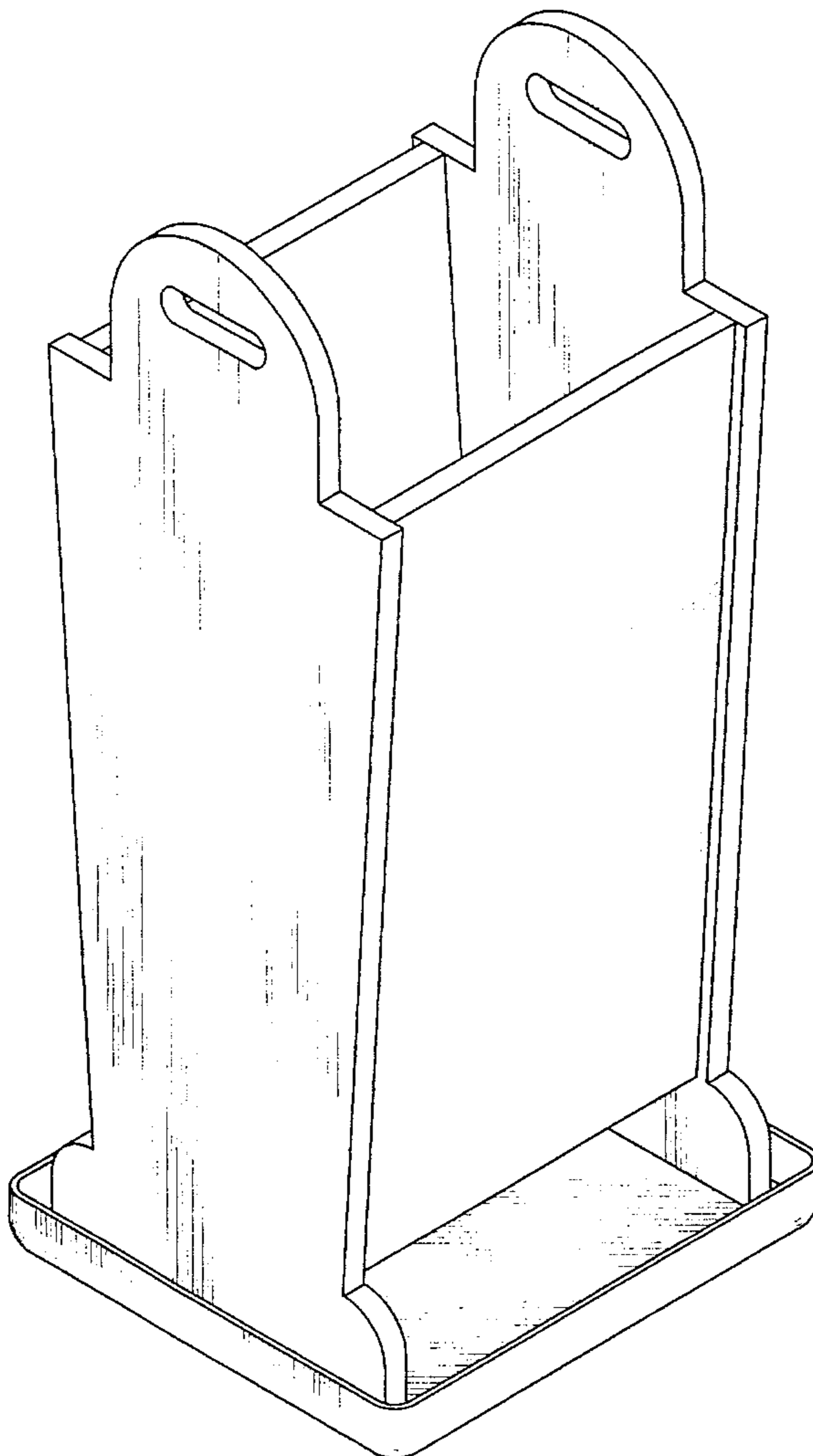

FIG. 1

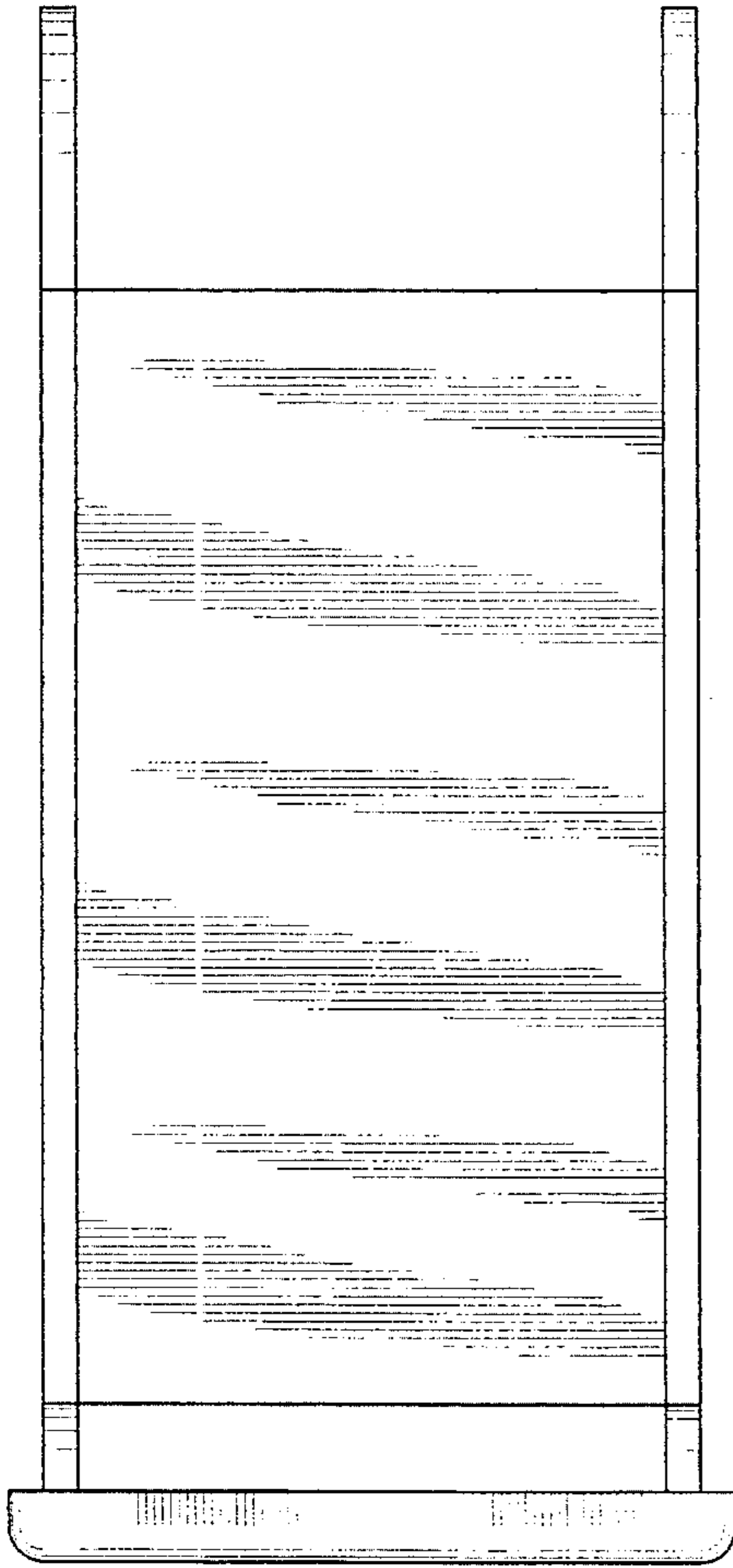

FIG. 2

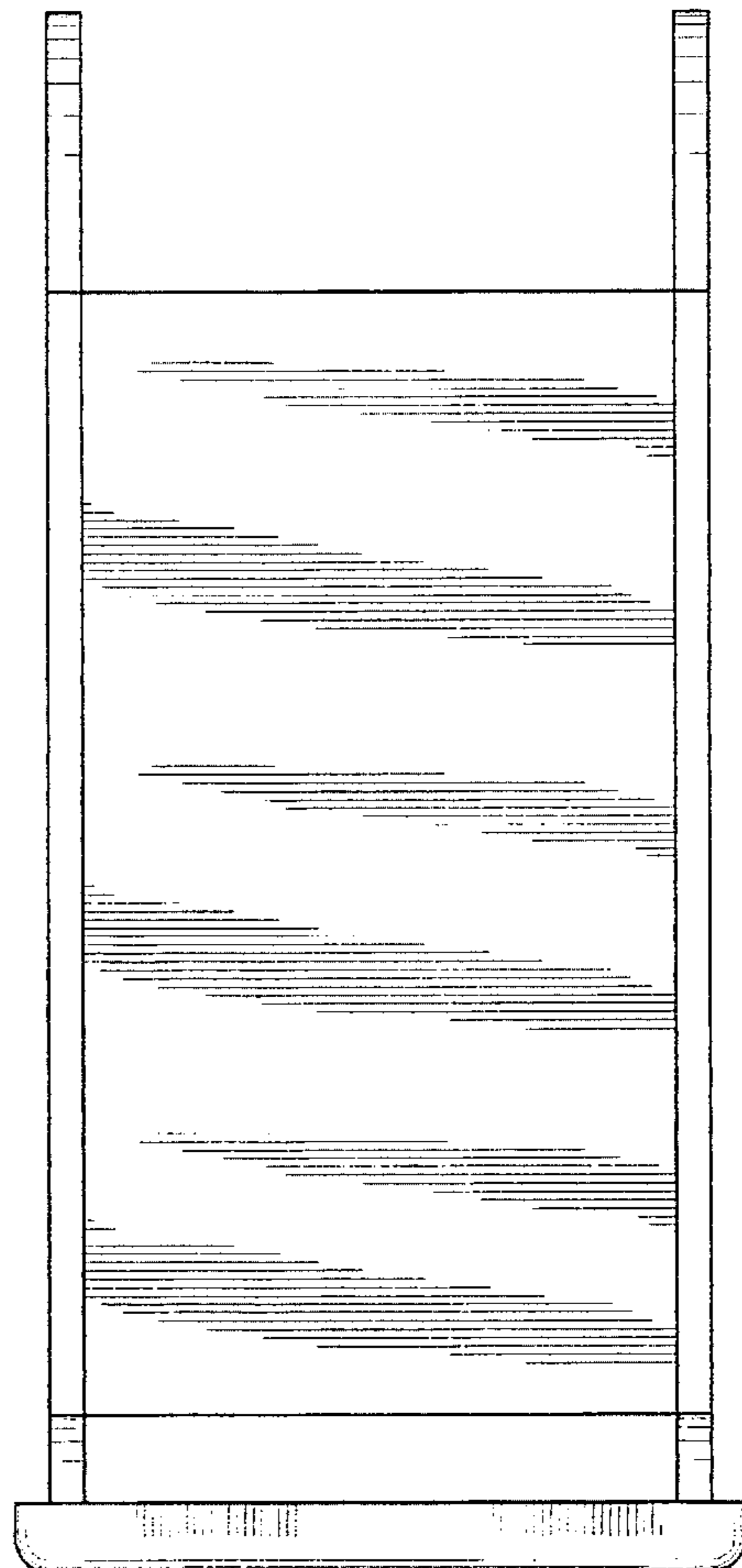

FIG. 3

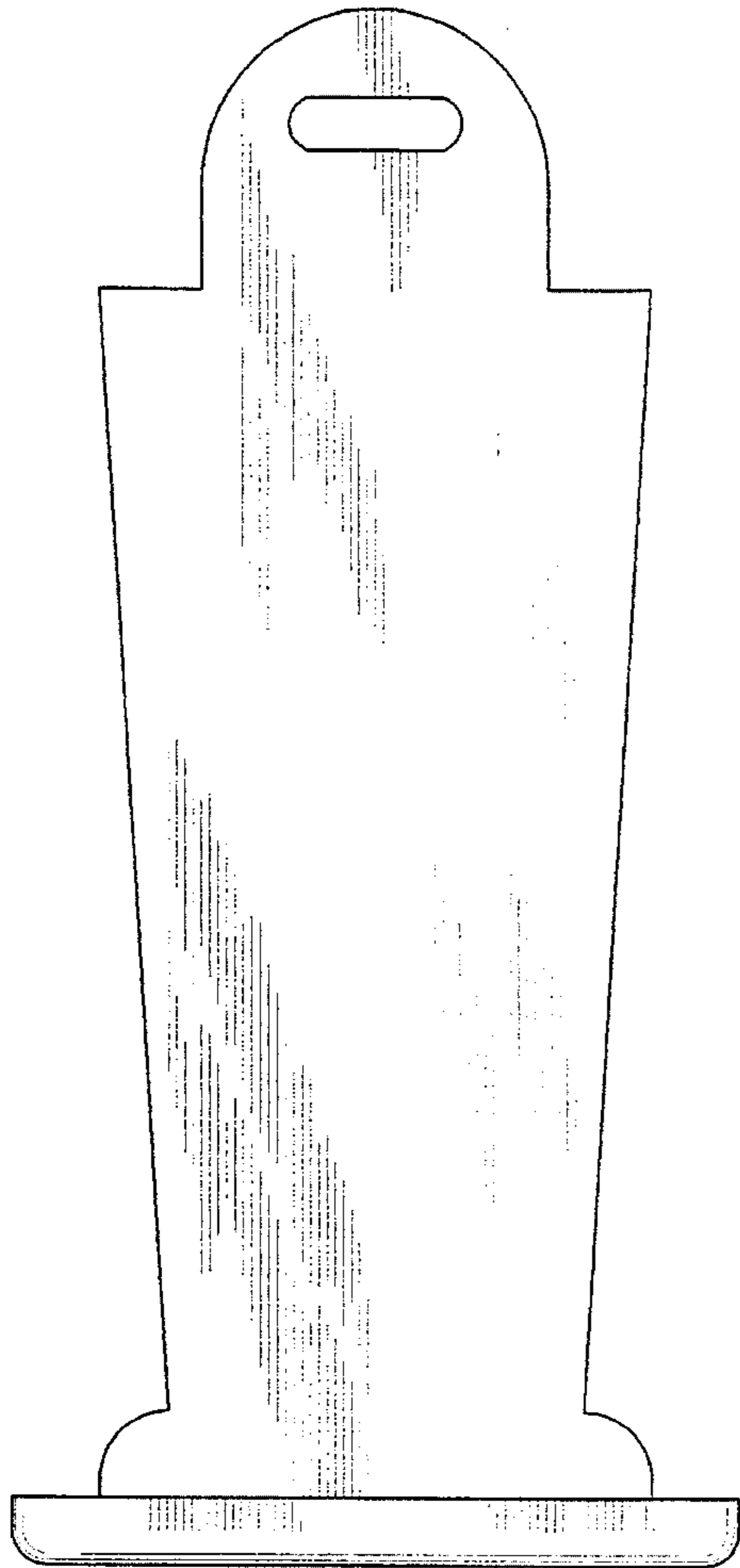

FIG. 4

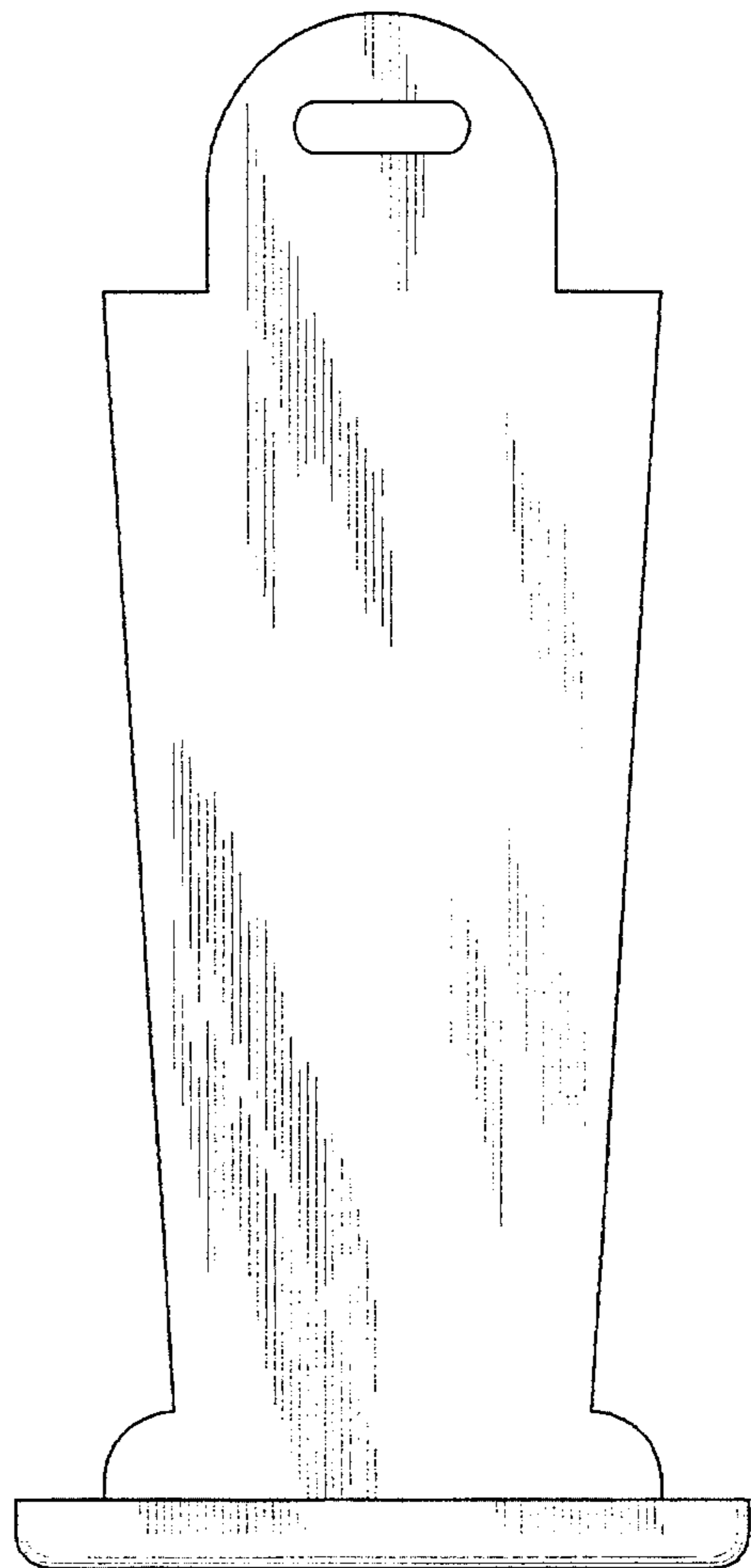

FIG. 5

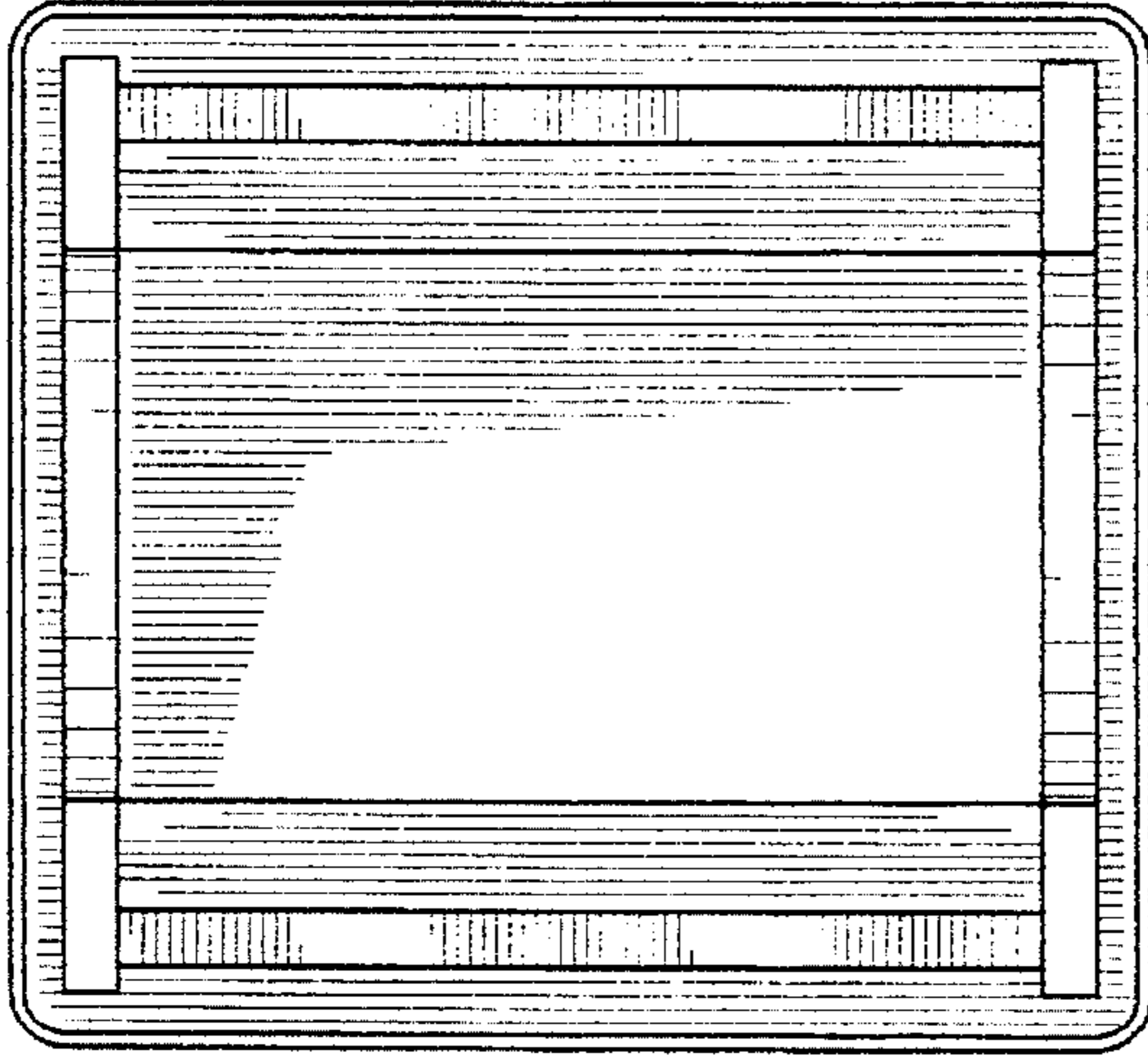

FIG. 6

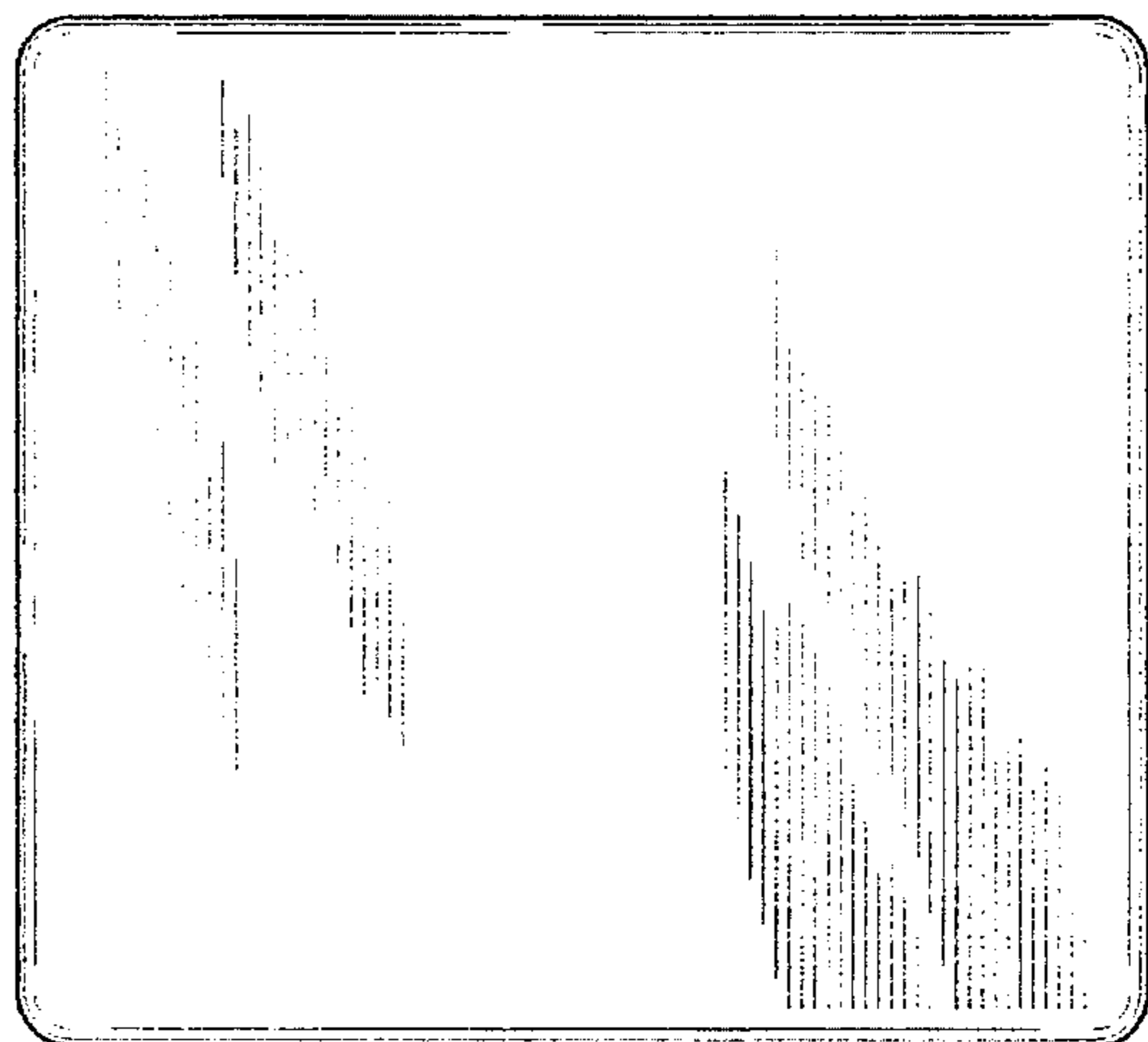

FIG. 7

