



US00D367340S

United States Patent [19] Dunn

[11] Patent Number: **Des. 367,340**
[45] Date of Patent: ****Feb. 20, 1996**

[54] **DENTAL FLOSS DISPENSER**
[75] Inventor: **Steven B. Dunn**, Beverly Hills, Calif.
[73] Assignee: **Munchkin Bottling, Inc.**, Van Nuys, Calif.
[**] Term: **14 Years**
[21] Appl. No.: **24,197**
[22] Filed: **Jun. 16, 1994**
[52] U.S. Cl. **D28/64**
[58] Field of Search D28/64; 132/321-329; D6/515, 495; D21/199, 204-205; D9/305, 307; D19/78; D7/604, 571, 301; D11/157; D99/34-35, 37; D20/3, 7

D. 311,259 10/1990 Smith D28/64
D. 323,525 1/1992 Wong D11/157 X
D. 326,114 5/1992 Murtagh D19/97
D. 327,775 7/1992 Turner D21/204 X
D. 330,284 10/1992 Klien et al. D21/204 X
D. 339,239 9/1993 Perkins D21/204 X
D. 339,240 9/1993 Perkins D21/205 X
D. 339,884 9/1993 Hartman D28/64
D. 340,073 10/1993 Turner D21/204 X
D. 340,075 10/1993 Turner D21/204 X
D. 340,076 10/1993 Turner D21/204 X
D. 340,078 10/1993 Turner D19/82
D. 340,367 10/1993 Mansson D21/204 X
D. 343,327 1/1994 Bailey et al. D7/301
D. 345,032 3/1994 Curtis et al. D28/64

(List continued on next page.)

OTHER PUBLICATIONS

John Deere Holidays 1990 Catalogue, Athletic pillows, p. 9.
Potpourri Catalogue, lock-in security padlocks, p. 62 Spring 1989.
Hong Kong Enterprise, Alarm Clocks, p. 103 Feb. 1990.
Plaza Sport Shop Trophy Catalog, Item #1008 p. 20 copyright 1955, trophy box.

Primary Examiner—M. H. Tung
Attorney, Agent, or Firm—Woodcock Washburn Kurtz Mackiewicz & Norris

[57] CLAIM

An ornamental design for a dental floss dispenser, as shown and described.

DESCRIPTION

FIG. 1 is a perspective view of a dental floss dispenser on a reduced scale, the broken line drawing of dental floss is for illustrative purposes only and forms no part of the claimed design;
FIG. 2 is a front elevational view;
FIG. 3 is a rear elevational view;
FIG. 4 is a first side elevational view;
FIG. 5 is a second side elevational view;
FIG. 6 is a top plan view of the embodiment; and,
FIG. 7 is a bottom plan view.

1 Claim, 3 Drawing Sheets

[56] References Cited

U.S. PATENT DOCUMENTS

D. 18,300 5/1888 Chase D21/204 X
D. 40,144 7/1909 Clungeon D21/204 X
D. 208,314 8/1967 Guerrero D99/37
D. 209,219 11/1967 Goldstein et al. D99/37
D. 220,769 5/1971 LaHue D21/204
D. 223,940 6/1972 Whitworth D99/37
D. 232,957 9/1974 Kahelin D21/205
D. 257,402 10/1980 Denton et al. D28/64
D. 258,125 2/1981 Bailey D11/157
D. 266,194 9/1982 Graves D28/64
D. 266,436 10/1982 Smith D19/82 X
D. 270,899 10/1983 Huang D19/82 X
D. 271,173 11/1983 Keshishian D7/17
D. 275,780 10/1984 Pearson D21/205 X
D. 286,551 11/1986 Satterfield D19/82
D. 286,552 11/1986 Satterfield D19/82
D. 286,940 12/1986 Saladino et al. D21/204 X
D. 286,942 12/1986 Saladino et al. D21/204 X
D. 286,943 12/1986 Saladino et al. D21/204 X
D. 287,766 1/1987 Simmons D24/198
D. 287,767 1/1987 Simmons D24/198
D. 290,539 6/1987 Jennette D21/204 X
D. 291,562 8/1987 Lee D11/157 X
D. 292,991 12/1987 Adler D9/307 X
D. 293,690 1/1988 Adler D19/78
D. 305,696 1/1990 Woodman D28/64
D. 306,500 3/1990 Brahler D28/64
D. 310,273 8/1990 Woodman D28/64

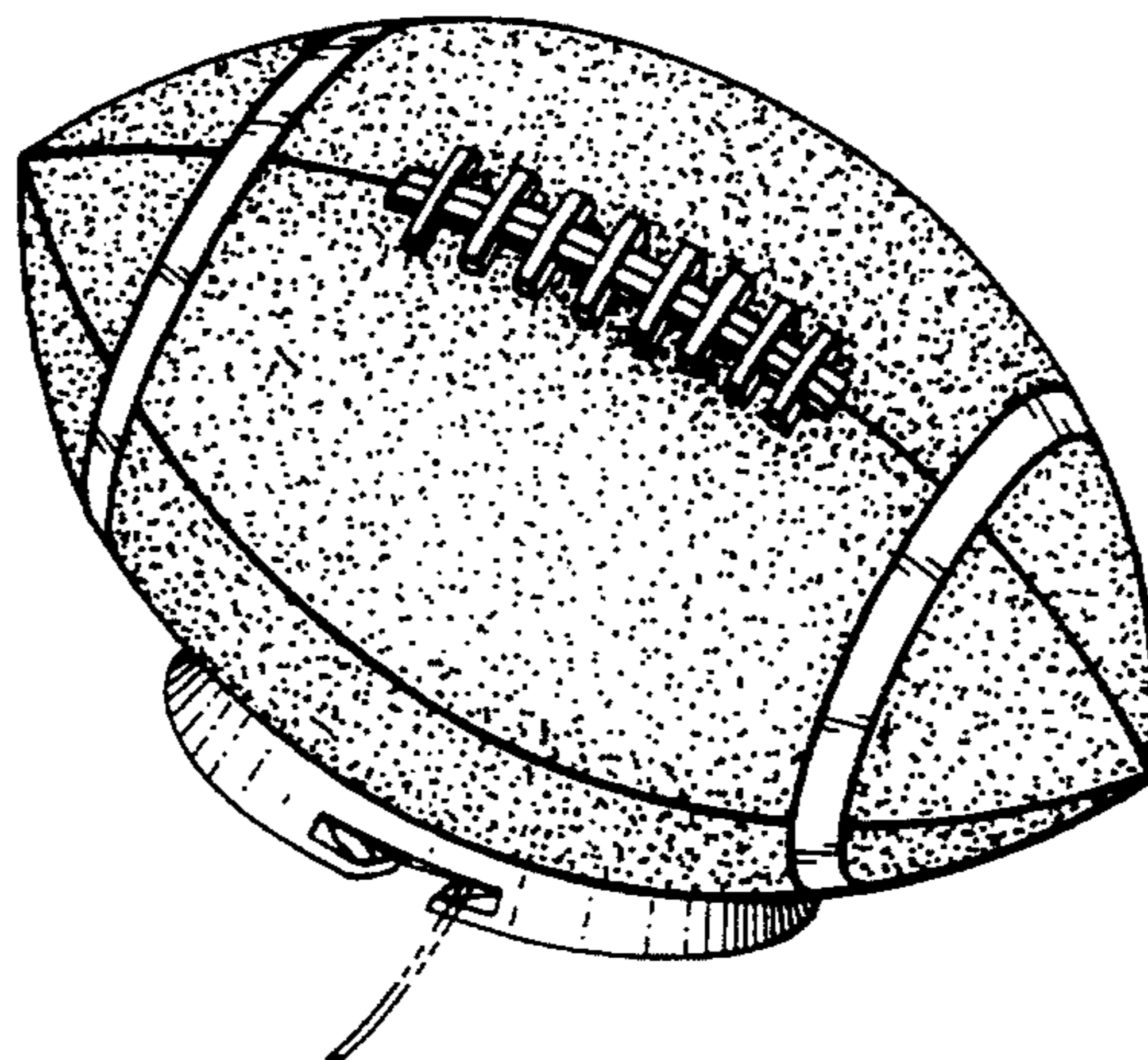

Des. 367,340

Page 2

U.S. PATENT DOCUMENTS

D. 345,824	4/1994	Fitz	D28/64	3,624,939	12/1971	Gossard	D9/307 X
D. 349,134	7/1994	Peersmann	D11/157 X	4,164,284	8/1979	Witt et al.	D9/307 X
D. 354,642	1/1995	Stoddard et al.	D7/301 X	4,308,880	1/1982	Graves	132/92
3,540,735	11/1970	Miller	D21/204 X	4,635,660	1/1987	Graves	132/92
				5,119,941	6/1992	Lepie	206/102
				5,246,022	9/1993	Israel et al.	132/324

FIG. 1

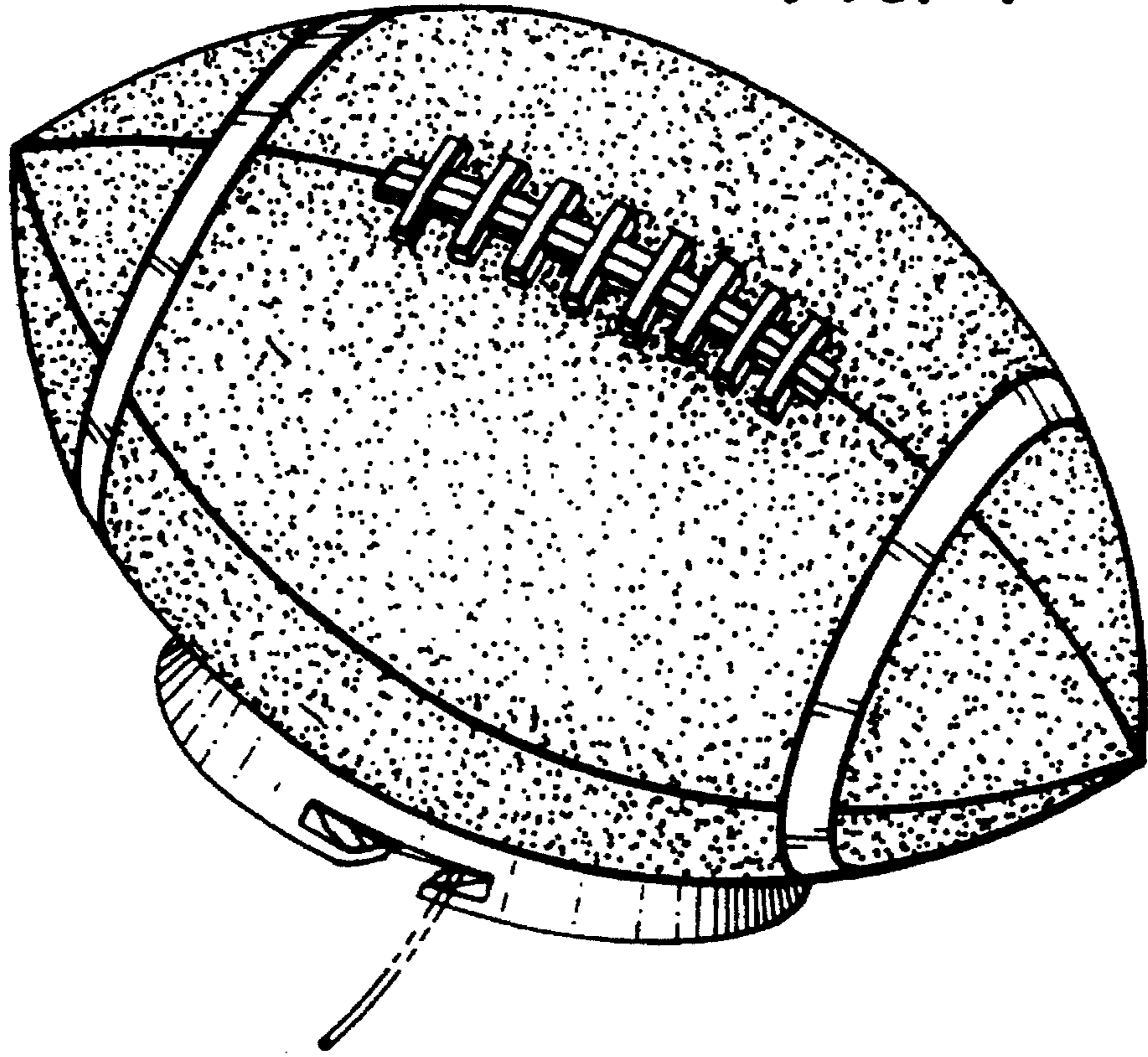

FIG. 2

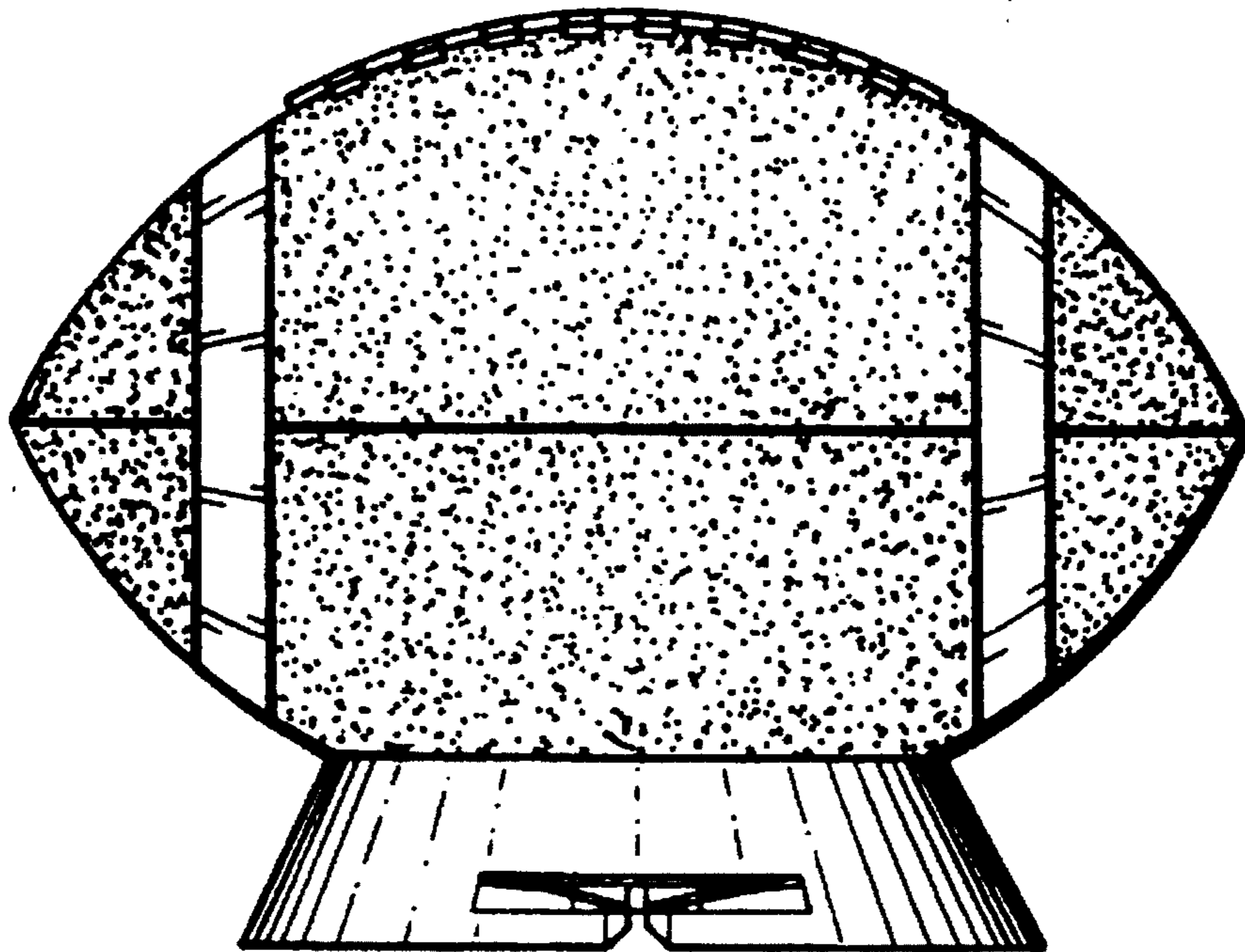

FIG. 3

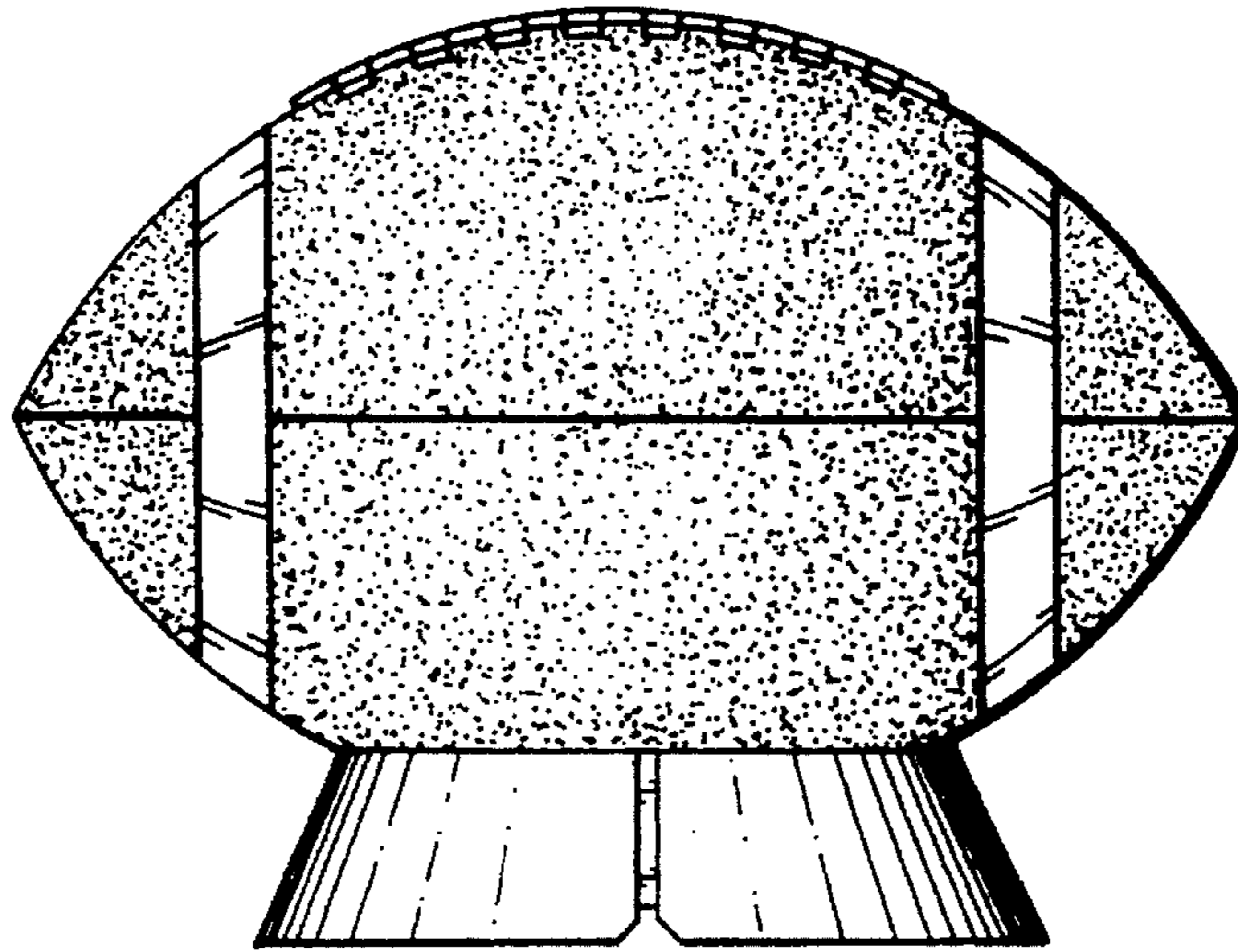

FIG. 4

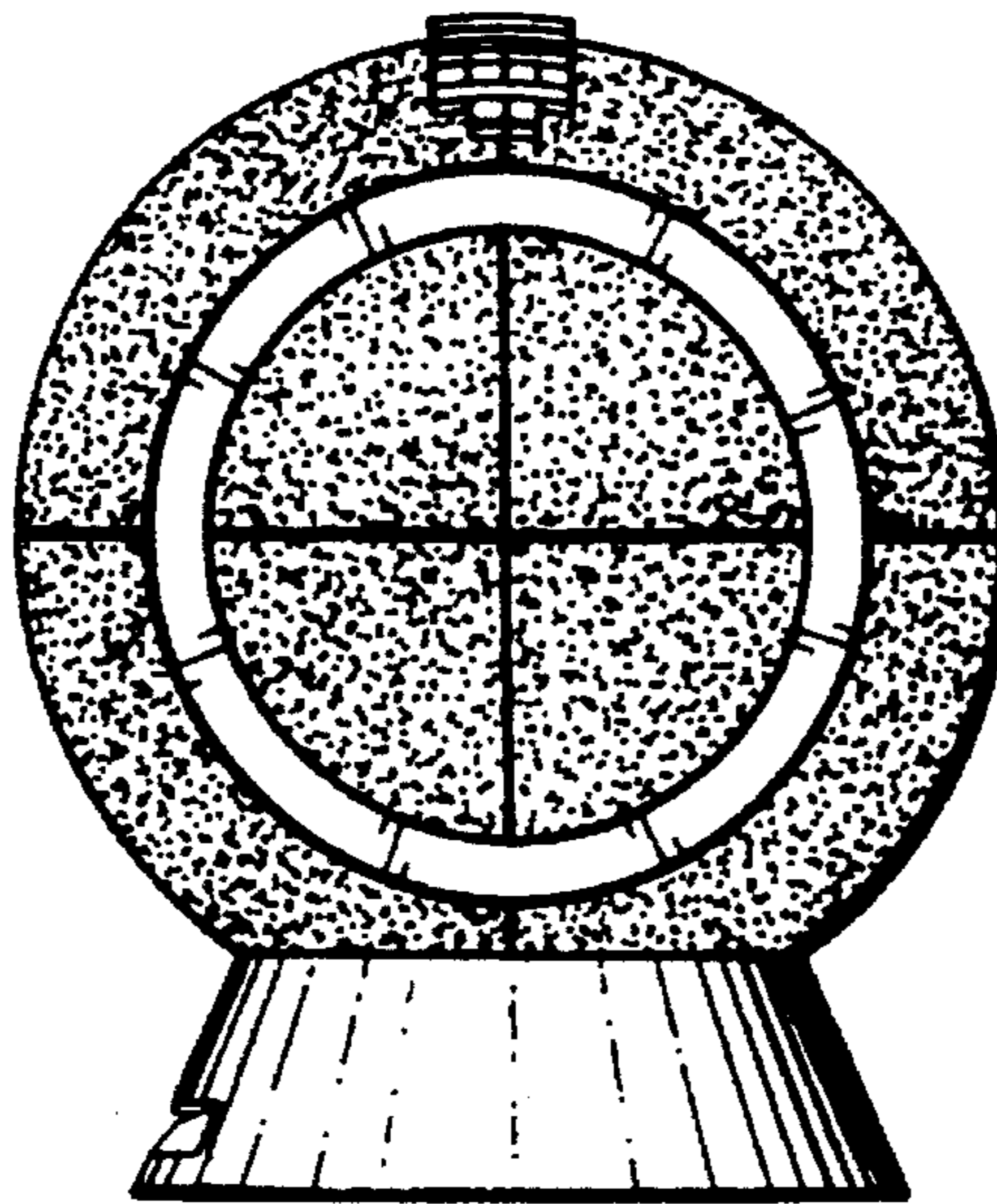

FIG. 5

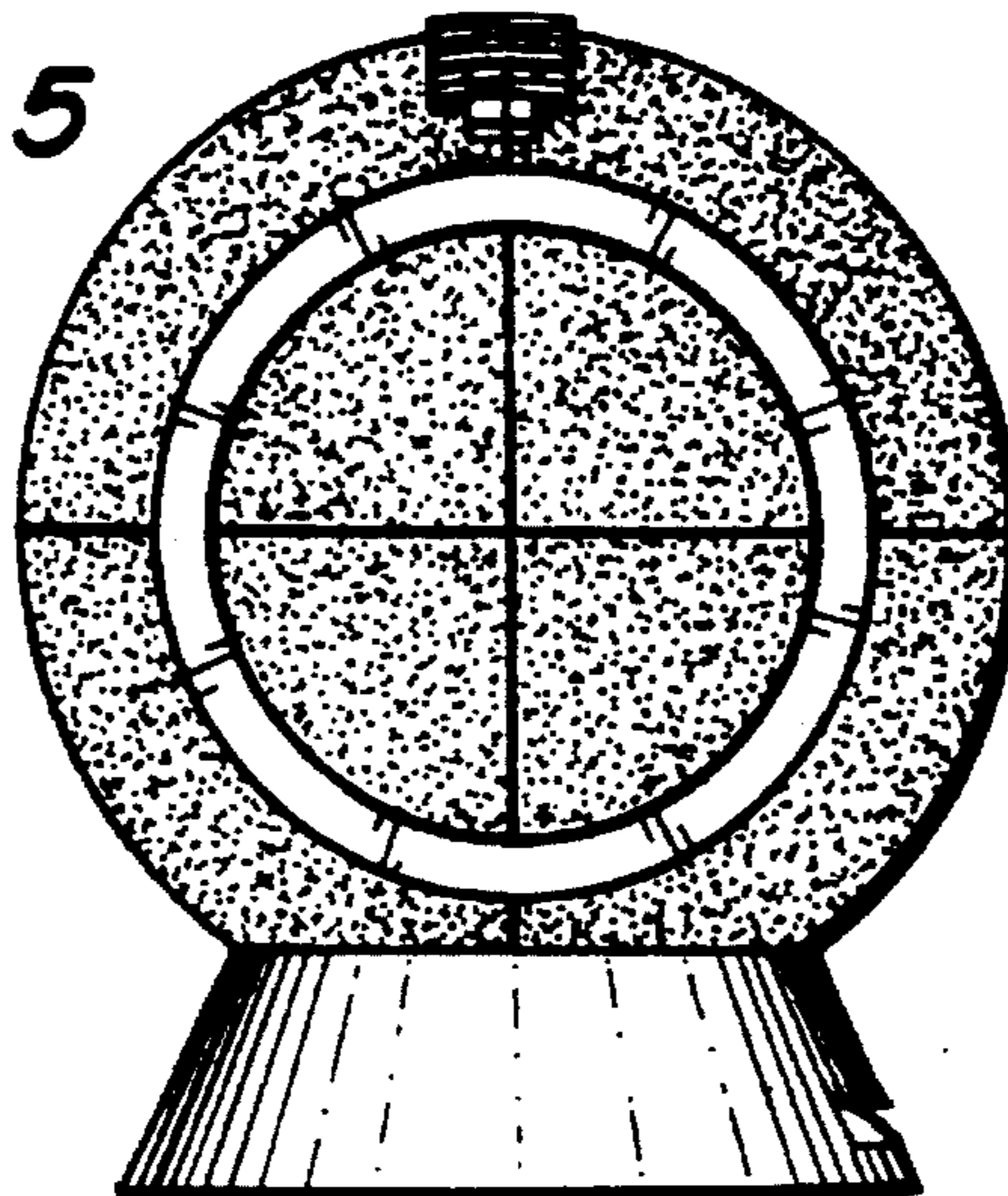

FIG. 6

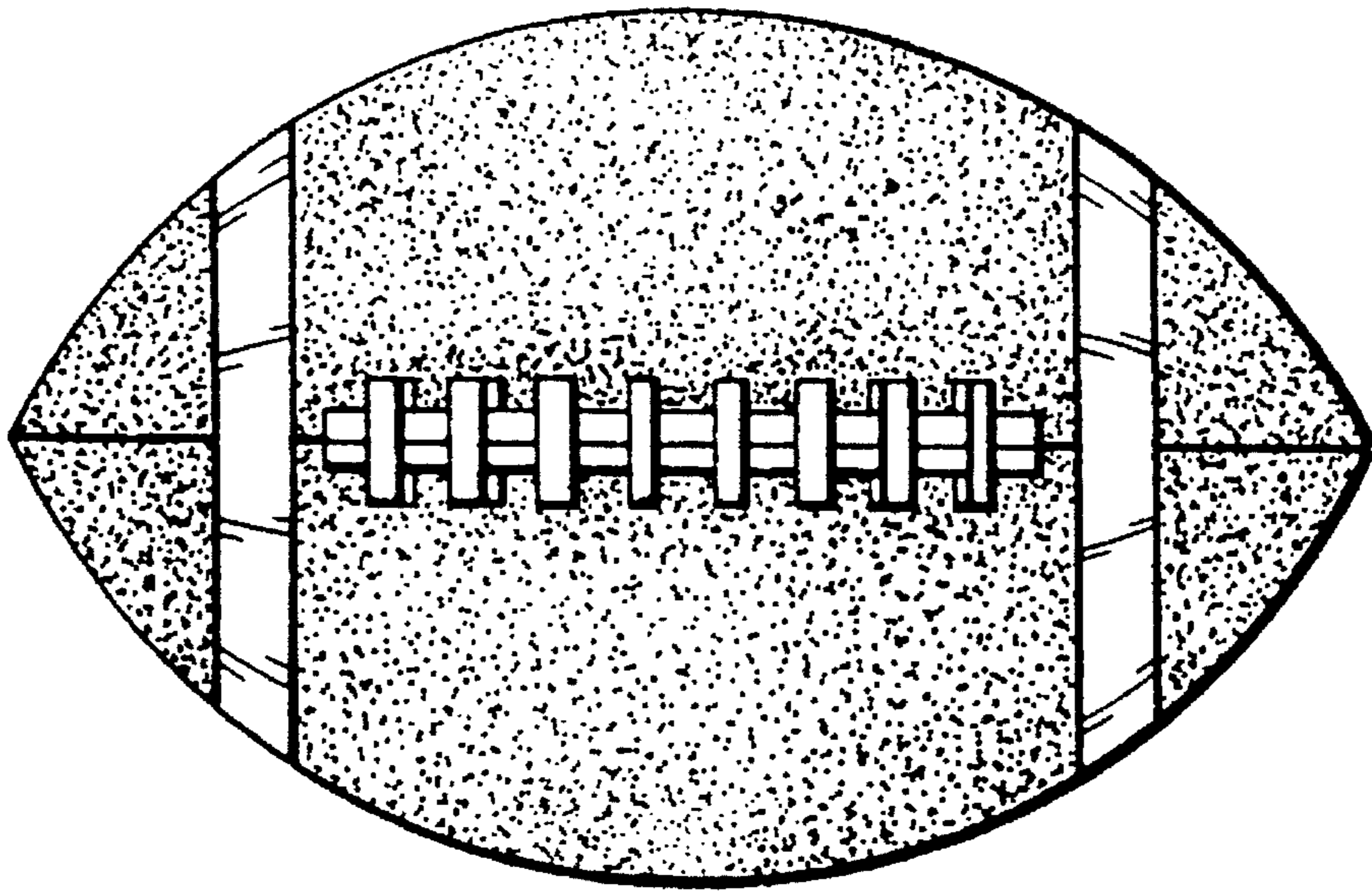
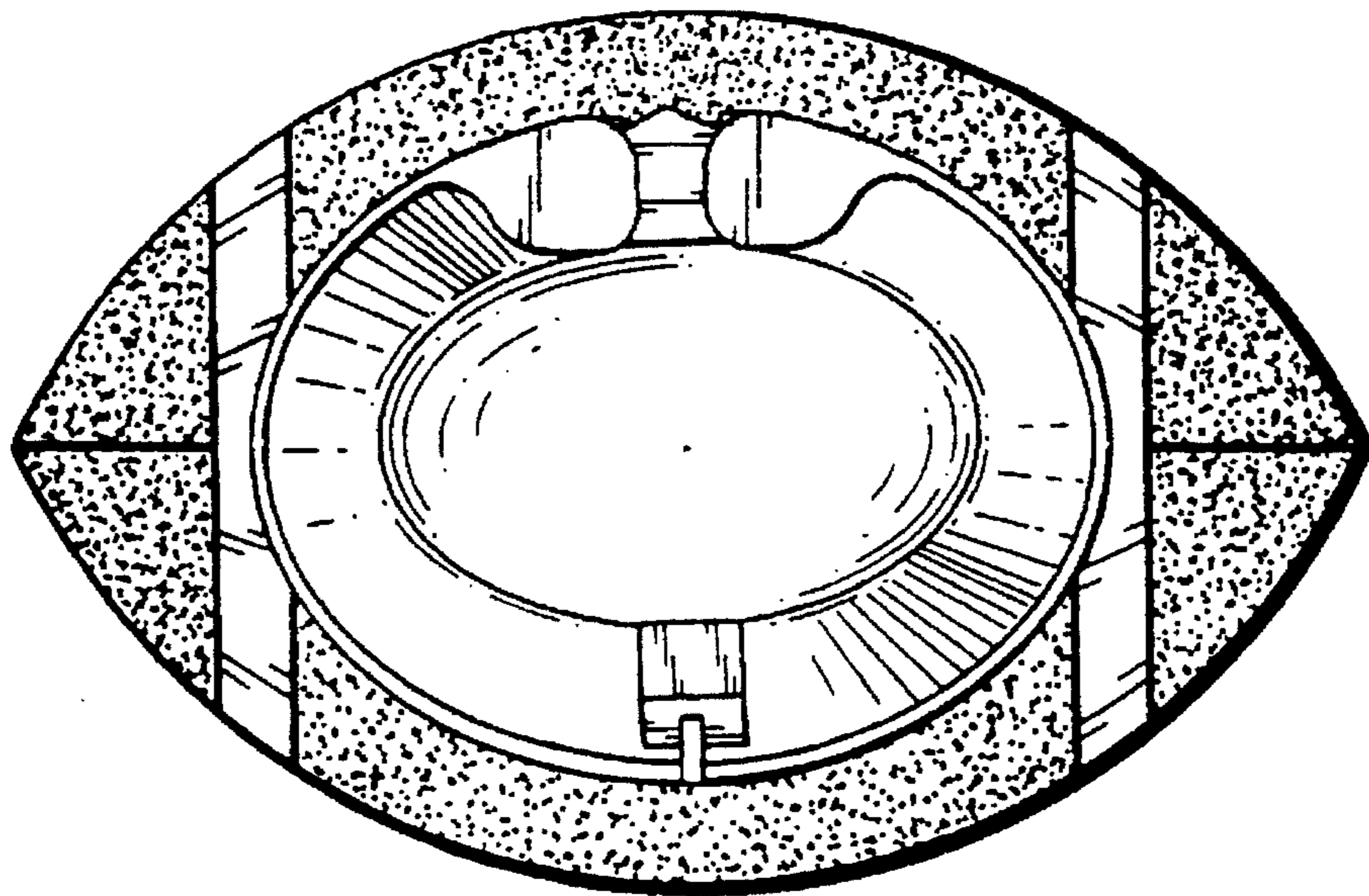

FIG. 7



UNITED STATES PATENT AND TRADEMARK OFFICE
CERTIFICATE OF CORRECTION

PATENT NO. : D367,340

Page 1 of 6

DATED : February 20, 1996

INVENTOR(S) : Dunn

It is certified that error appears in the above-identified patent and that said Letters Patent is hereby corrected as shown below:

The title page, showing an illustrative figure, should be deleted and substituted therefor the attached title page.

In the Drawings:

Delete drawing sheets 1-3, and substitute therefor the Drawing sheets, consisting of Figures 1-7, as shown on the attached pages.

Signed and Sealed this
Sixth Day of August, 1996



BRUCE LEHMAN

Attest:

Attesting Officer

Commissioner of Patents and Trademarks

[54] DENTAL FLOSS DISPENSER

[75] Inventor: Steven B. Dunn, Beverly Hills, Calif.

[73] Assignee: Munchkin Bottling, Inc., Van Nuys, Calif.

[**] Term: 14 Years

[21] Appl. No.: 24,197

[22] Filed: Jun. 16, 1994

[52] U.S. Cl. D28/64

[58] Field of Search D28/64; 132/321-329; D6/515, 495; D21/199, 204-205; D9/305, 307; D19/78; D7/604, 571, 301; D11/157; D99/34-35, 37; D20/3, 7

[56] References Cited

U.S. PATENT DOCUMENTS

D. 18,300	5/1888	Chase	D21/204 X
D. 40,144	7/1909	Clungeon	D21/204 X
D. 208,314	8/1967	Guerrero	D99/37
D. 209,219	11/1967	Goldstein et al.	D99/37
D. 220,769	5/1971	LaHue	D21/204
D. 223,940	6/1972	Whitworth	D99/37
D. 232,957	9/1974	Kahelin	D21/205
D. 257,402	10/1980	Denton et al.	D28/64
D. 258,125	2/1981	Bailey	D11/157
D. 266,194	9/1982	Graves	D28/64
D. 266,436	10/1982	Smith	D19/82 X
D. 270,899	10/1983	Huang	D19/82 X
D. 271,173	11/1983	Keshishian	D7/17
D. 275,780	10/1984	Pearson	D21/205 X
D. 286,551	11/1986	Satterfield	D19/82
D. 286,552	11/1986	Satterfield	D19/82
D. 286,940	12/1986	Saladino et al.	D21/204 X
D. 286,942	12/1986	Saladino et al.	D21/204 X
D. 286,943	12/1986	Saladino et al.	D21/204 X
D. 287,766	1/1987	Simmons	D24/198
D. 287,767	1/1987	Simmons	D24/198
D. 290,539	6/1987	Jennette	D21/204 X
D. 291,562	8/1987	Lee	D11/157 X
D. 292,991	12/1987	Adler	D9/307 X
D. 293,690	1/1988	Adler	D19/78
D. 305,696	1/1990	Woodman	D28/64
D. 306,500	3/1990	Brahler	D28/64
D. 310,273	8/1990	Woodman	D28/64

D. 311,259	10/1990	Smith	D28/64
D. 323,525	1/1992	Wong	D11/157 X
D. 326,114	5/1992	Murtagh	D19/97
D. 327,775	7/1992	Turner	D21/204 X
D. 330,284	10/1992	Klien et al.	D21/204 X
D. 339,239	9/1993	Perkins	D21/204 X
D. 339,240	9/1993	Perkins	D21/205 X
D. 339,884	9/1993	Hartman	D28/64
D. 340,073	10/1993	Turner	D21/204 X
D. 340,075	10/1993	Turner	D21/204 X
D. 340,076	10/1993	Turner	D21/204 X
D. 340,078	10/1993	Turner	D19/82
D. 340,367	10/1993	Mansson	D21/204 X
D. 343,327	1/1994	Bailey et al.	D7/301
D. 345,032	3/1994	Curtis et al.	D28/64

(List continued on next page.)

OTHER PUBLICATIONS

John Deere Holidays 1990 Catalogue. Athletic pillows, p. 9. Potpourri Catalogue, lock-in security padlocks, p. 62 Spring 1989.

Hong Kong Enterprise. Alarm Clocks, p. 103 Feb. 1990.

Plaza Sport Shop Trophy Catalog, Item #1008 p. 20 copyright 1955, trophy box.

Primary Examiner—M. H. Tung

Attorney, Agent, or Firm—Woodcock Washburn Kurtz Mackiewicz & Norris

[57] CLAIM

An ornamental design for a dental floss dispenser, as shown and described.

DESCRIPTION

FIG. 1 is a perspective view of a dental floss dispenser on a reduced scale, the broken line drawing of dental floss is for illustrative purposes only and forms no part of the claimed design;

FIG. 2 is a front elevational view;

FIG. 3 is a rear elevational view;

FIG. 4 is a first side elevational view;

FIG. 5 is a second side elevational view;

FIG. 6 is a top plan view of the embodiment; and

FIG. 7 is a bottom plan view.

1 Claim, 3 Drawing Sheets

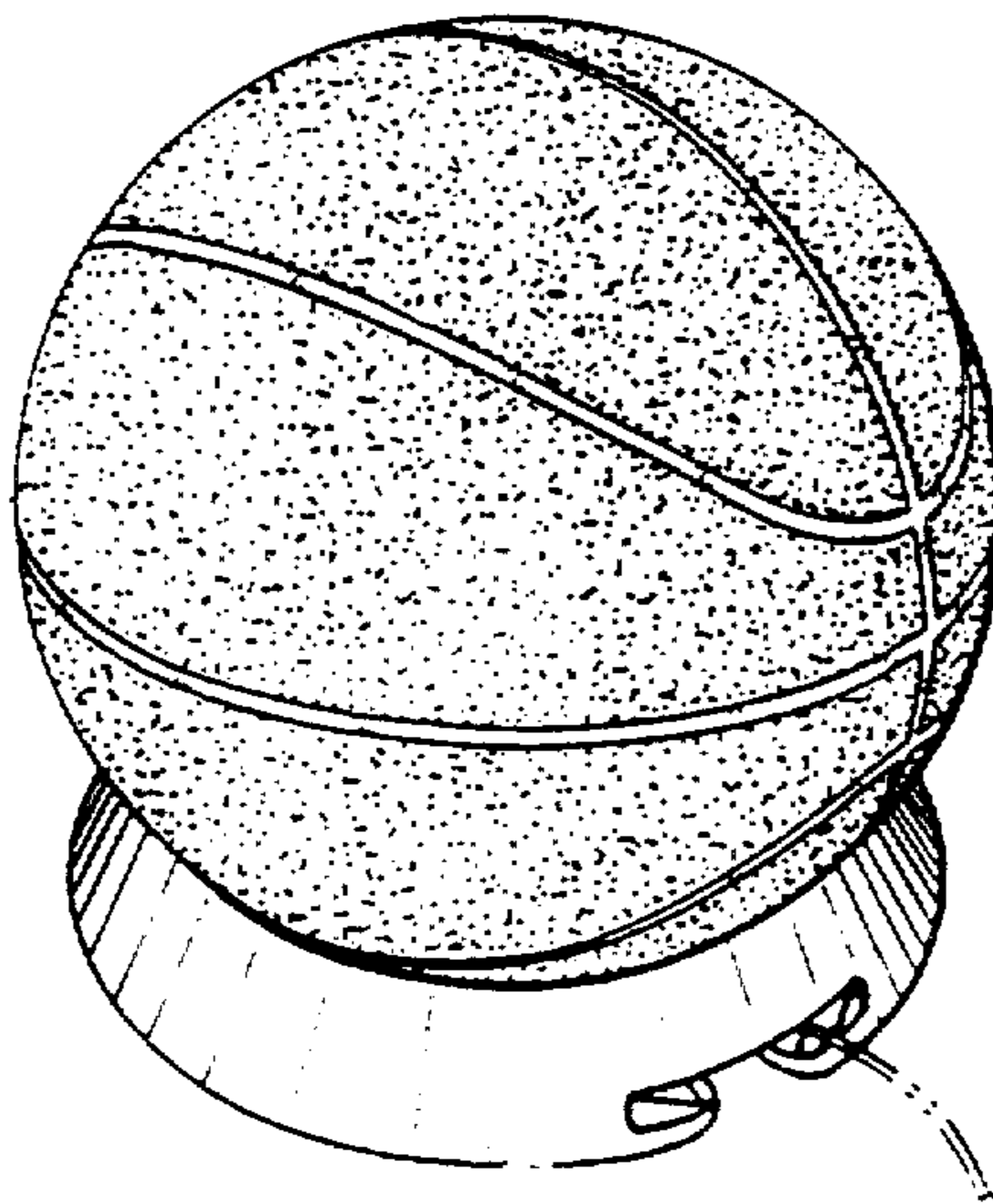

FIG. 1

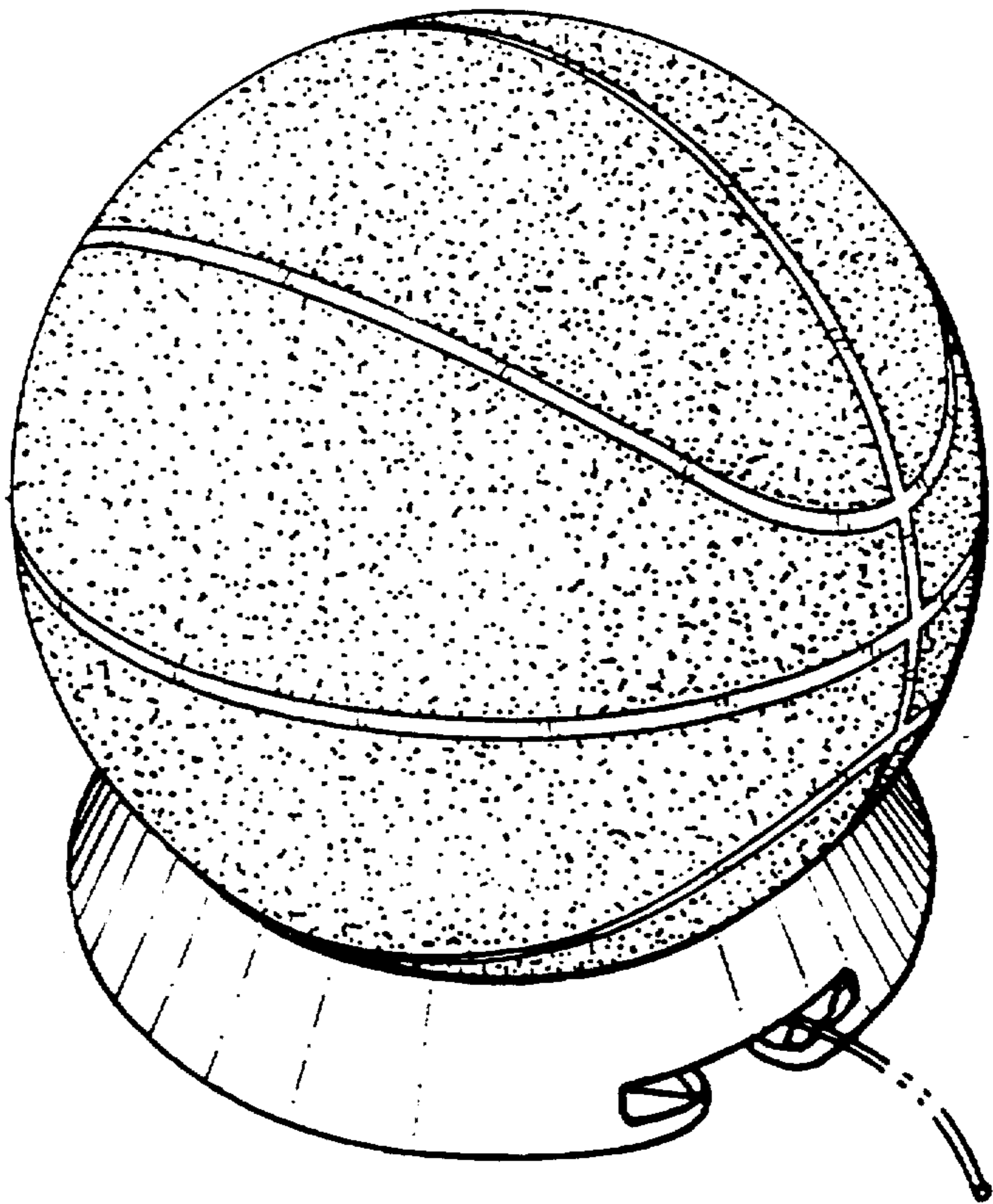

FIG. 5

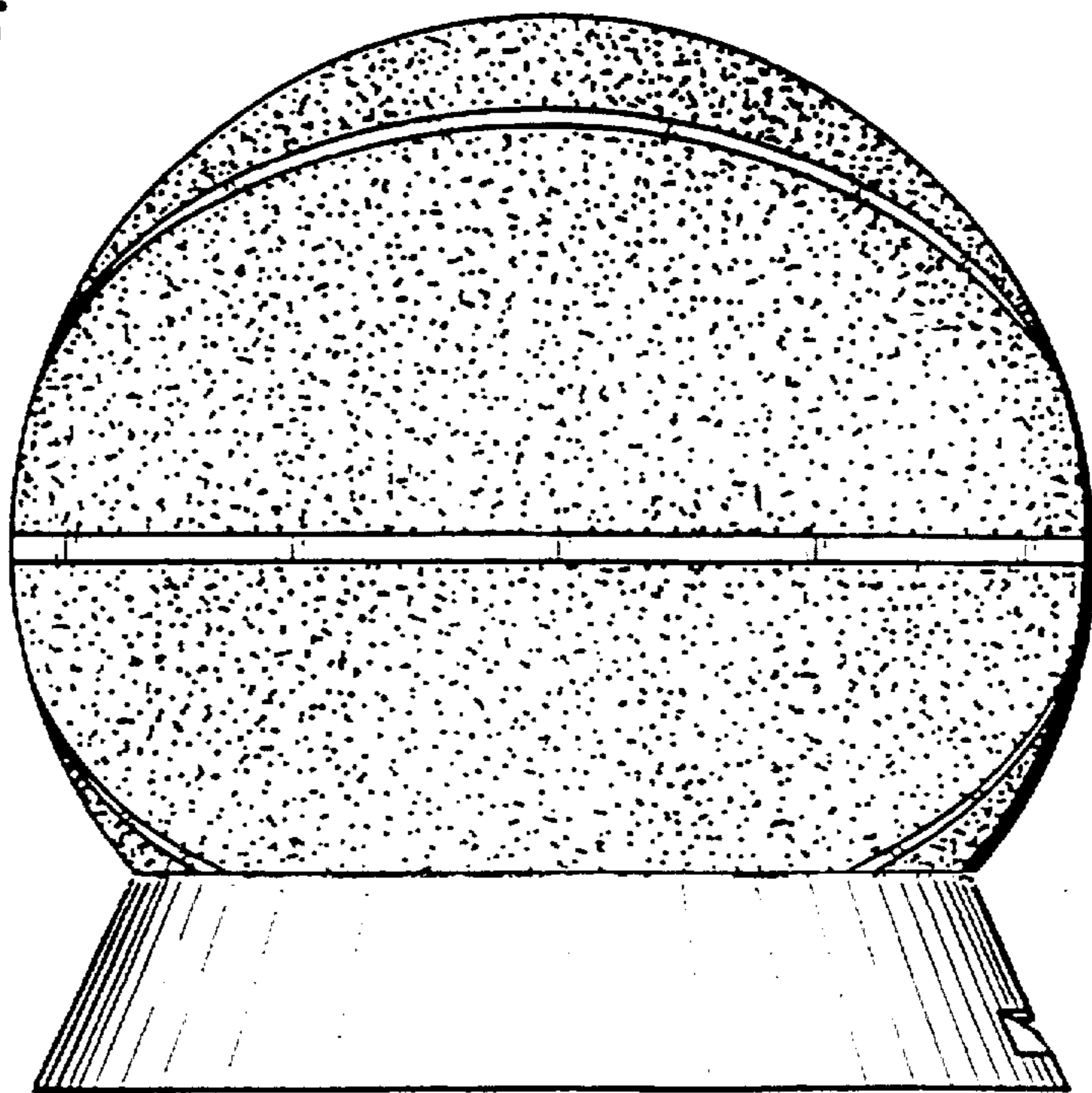

FIG. 2

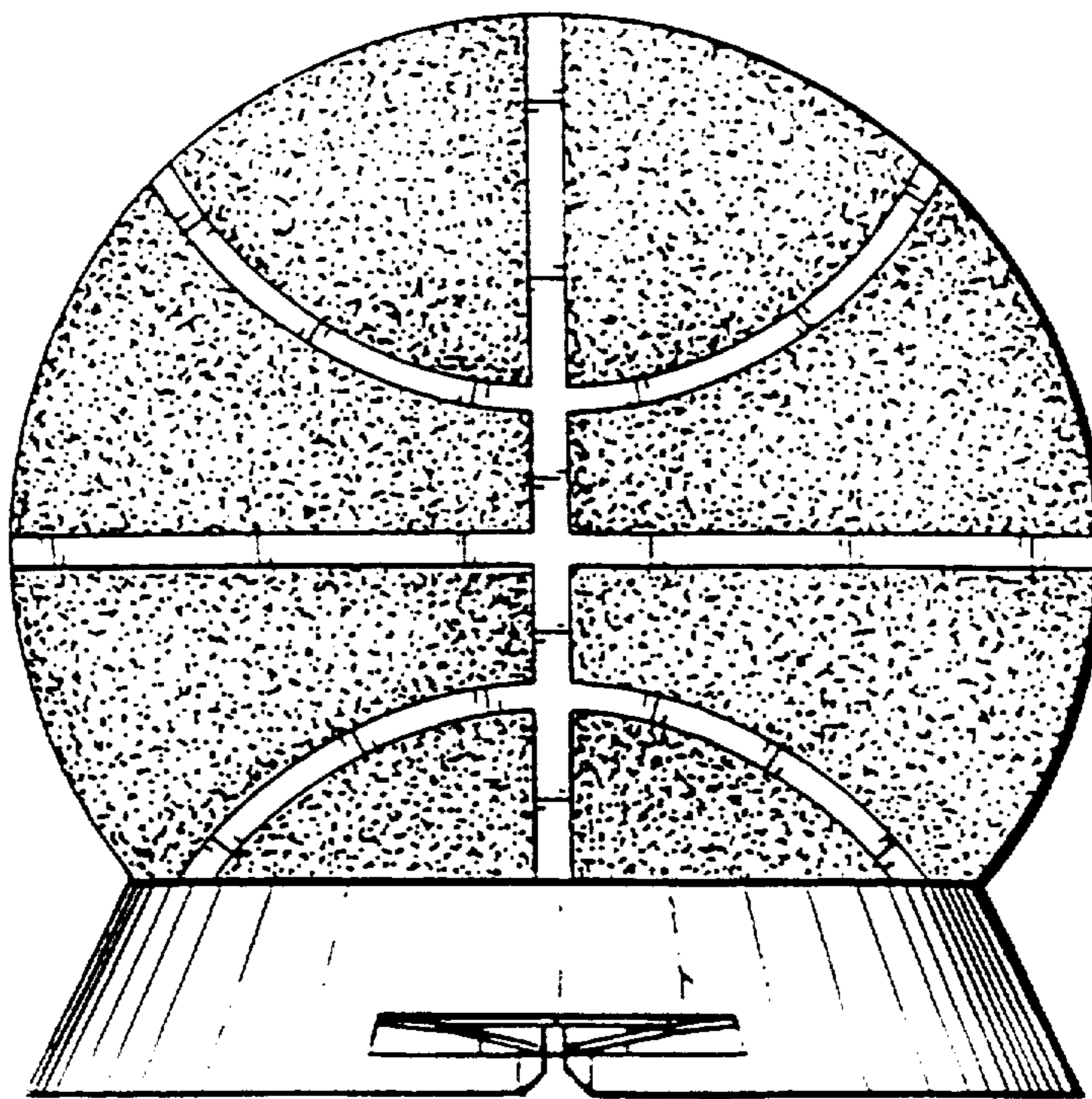

FIG. 6

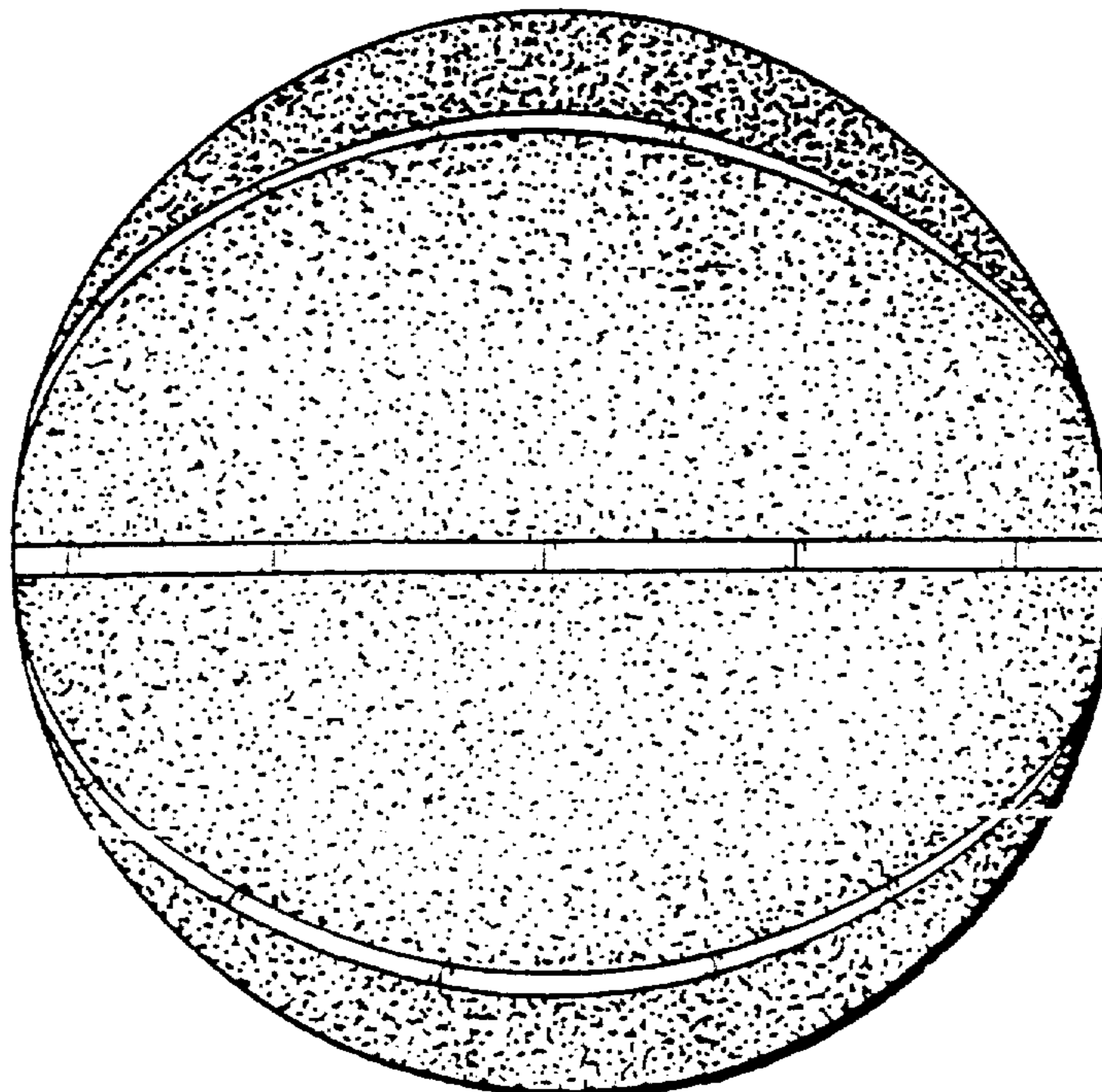

FIG. 4

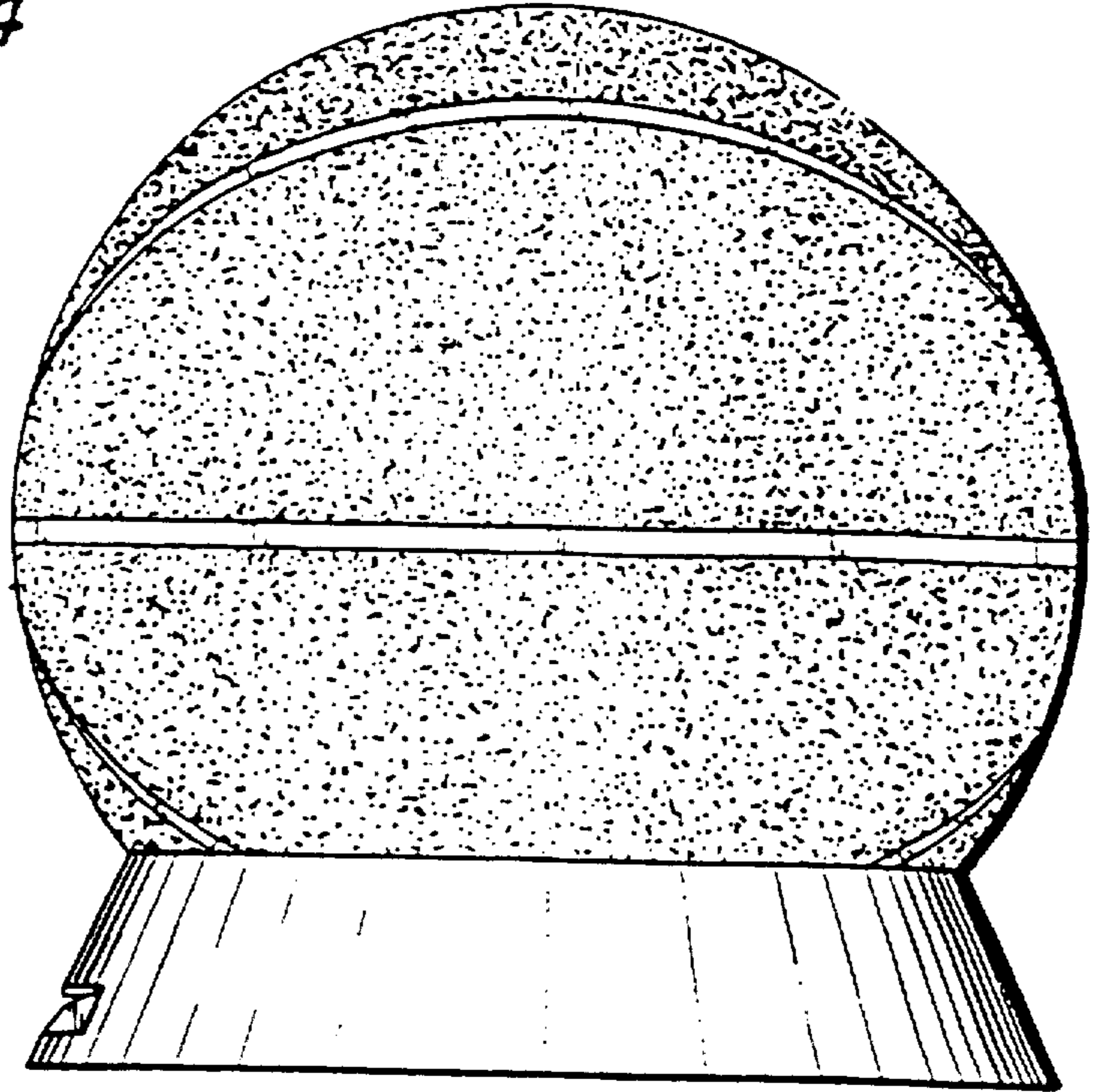

FIG. 3

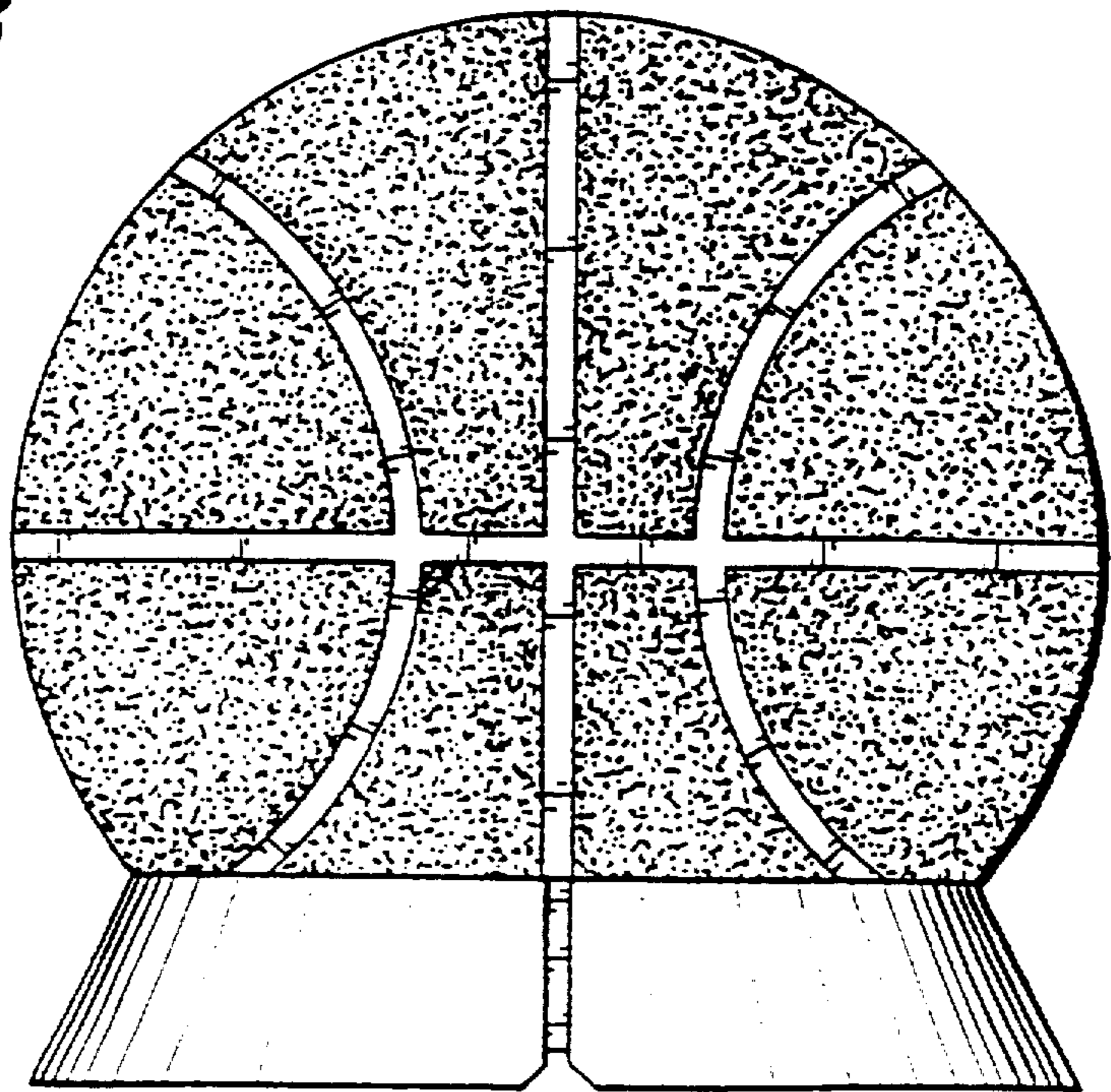

FIG. 7

