



US00D367323S

# United States Patent [19]

[11] Patent Number: Des. 367,323

Carr et al.

[45] Date of Patent: \*\*Feb. 20, 1996

## [54] SURGICAL TUBING CASSETTE

5,403,277 4/1995 Dodge et al. .... 604/30

[75] Inventors: **Raymond A. Carr**, Clearwater Beach;  
**T. Dan Moore**, St. Petersburg, both of Fla.

### OTHER PUBLICATIONS

Smith+Nephew Dyonics, Integrating Innovative Fluid Management with Arthroscopic Cutting Excellence, Intelijet, 1992 (6 pages).

[73] Assignee: **Linvatec Corporation**, Largo, Fla.

Smith+Nephew Dyonics, Intelijet Fluid Management System Tube Set Kit, Cat. No. 4298 (1 page).

[\*\*] Term: **14 Years**

Arthrotek, IES 1000, Integrated Endoscopy System, 1992 (8 pages).

[21] Appl. No.: **27,274**

*Primary Examiner*—Louis S. Zarfes

[22] Filed: **Aug. 10, 1994**

*Assistant Examiner*—I. Simmons

[52] U.S. Cl. .... **D24/111**; D24/129

*Attorney, Agent, or Firm*—Gene Warzecha

[58] Field of Search ..... D24/111, 128,  
D24/108, 112; 604/30, 34, 153, 118, 319,  
151; 417/477, 442, 476; 128/DIG. 12, DIG. 13

### [57] CLAIM

### [56] References Cited

The ornamental design for a surgical tubing cassette, as shown and described.

#### U.S. PATENT DOCUMENTS

#### DESCRIPTION

D. 342,312	12/1993	Pastrone et al. ....	D24/111
4,187,057	2/1980	Xanthopoulos .	
4,493,695	1/1985	Cook .	
4,627,833	12/1986	Cook .....	604/34
4,713,051	12/1987	Steppe et al. .	
4,758,238	7/1988	Sundblom et al. .	
4,963,131	10/1990	Worrich .....	604/34
5,125,891	6/1992	Hossain et al. .	
5,195,960	3/1993	Hossain et al. .	
5,246,422	9/1993	Favre .	
5,267,956	12/1993	Beuchat .	
5,282,787	2/1994	Worrich .	
5,302,093	4/1994	Owens et al. .	
5,364,342	11/1994	Beuchat et al. ....	604/30

FIG. 1 is a front perspective view of a surgical tubing cassette showing our new design;  
FIG. 2 is a front elevational view thereof, the broken line showing of the tubing is for illustrative purposes only and forms no part of the claimed design;  
FIG. 3 is a bottom view of FIG. 2;  
FIG. 4 is a top view of FIG. 2;  
FIG. 5 is a right side view of FIG. 2;  
FIG. 6 is a left side view of FIG. 2; and,  
FIG. 7 is a rear elevation view of FIG. 2.

1 Claim, 4 Drawing Sheets

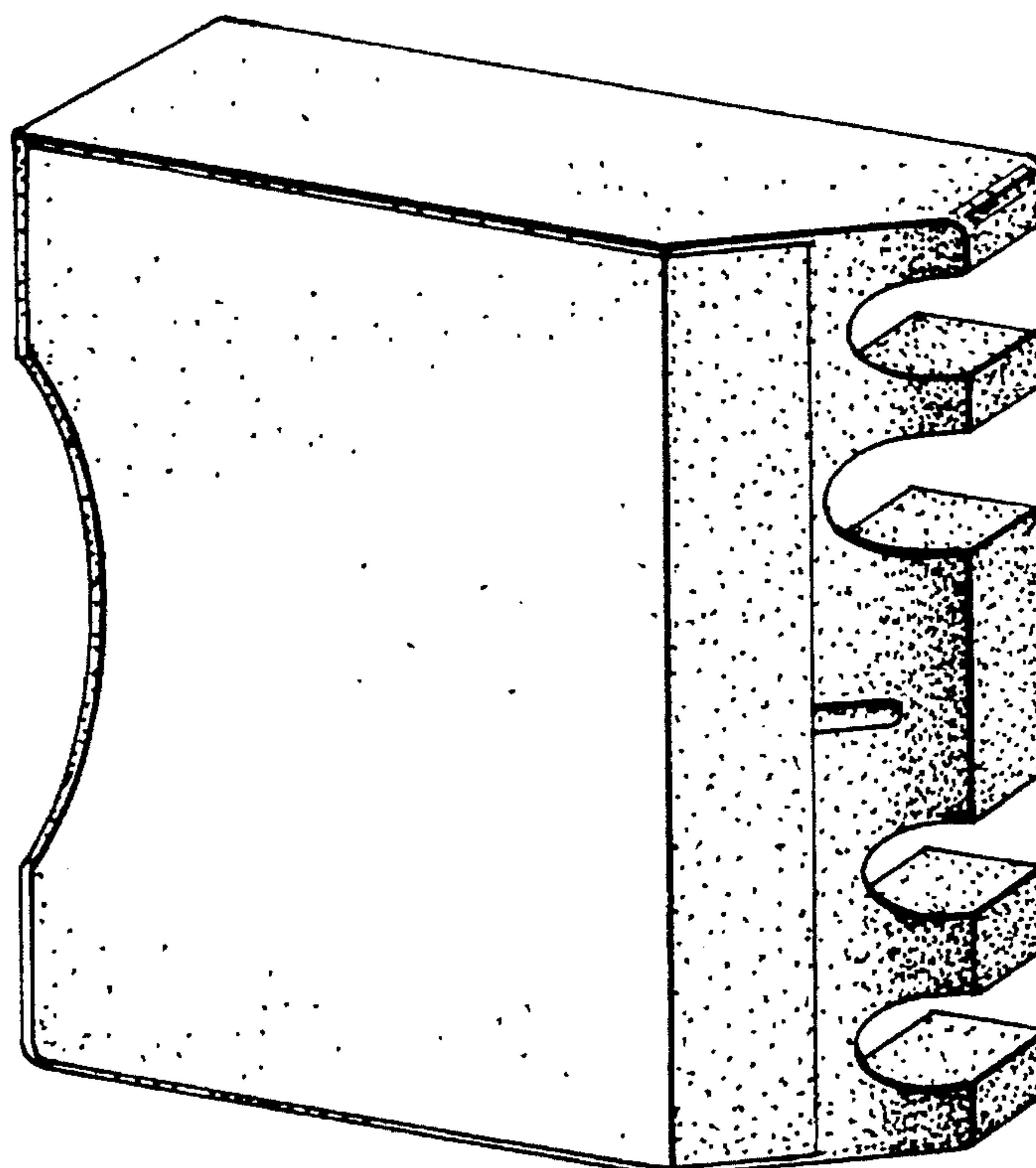

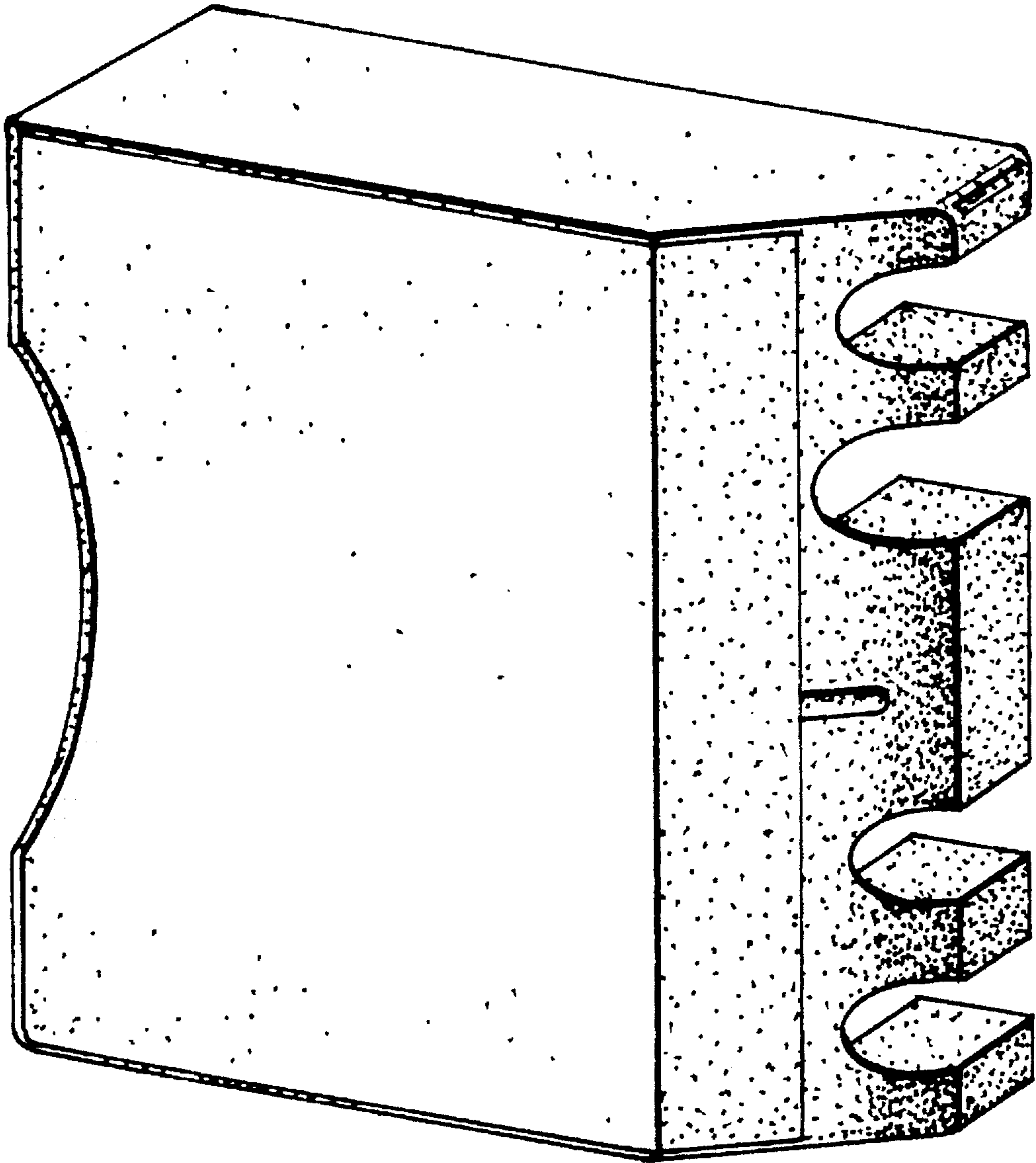

FIG. 1

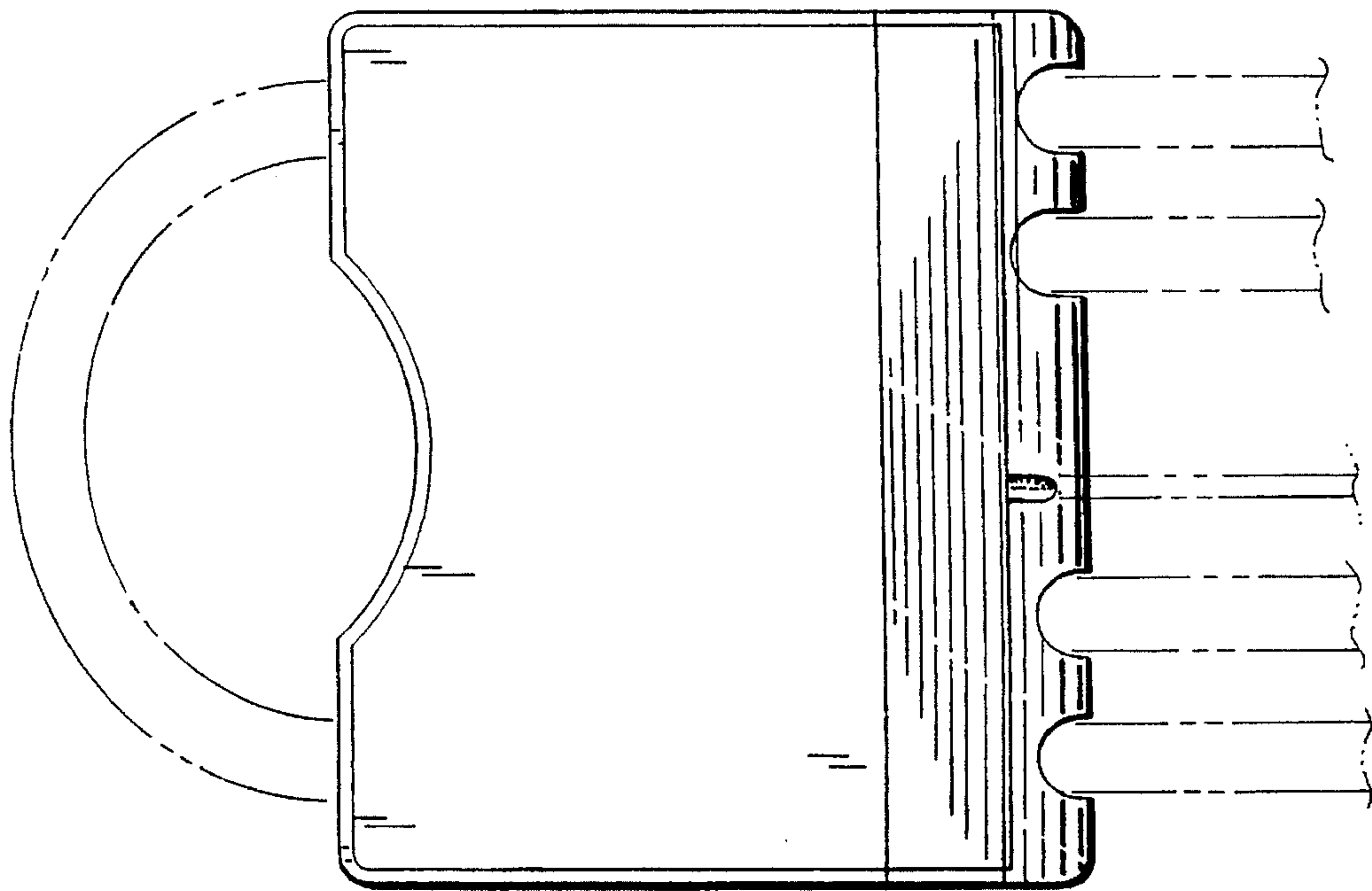

FIG. 2

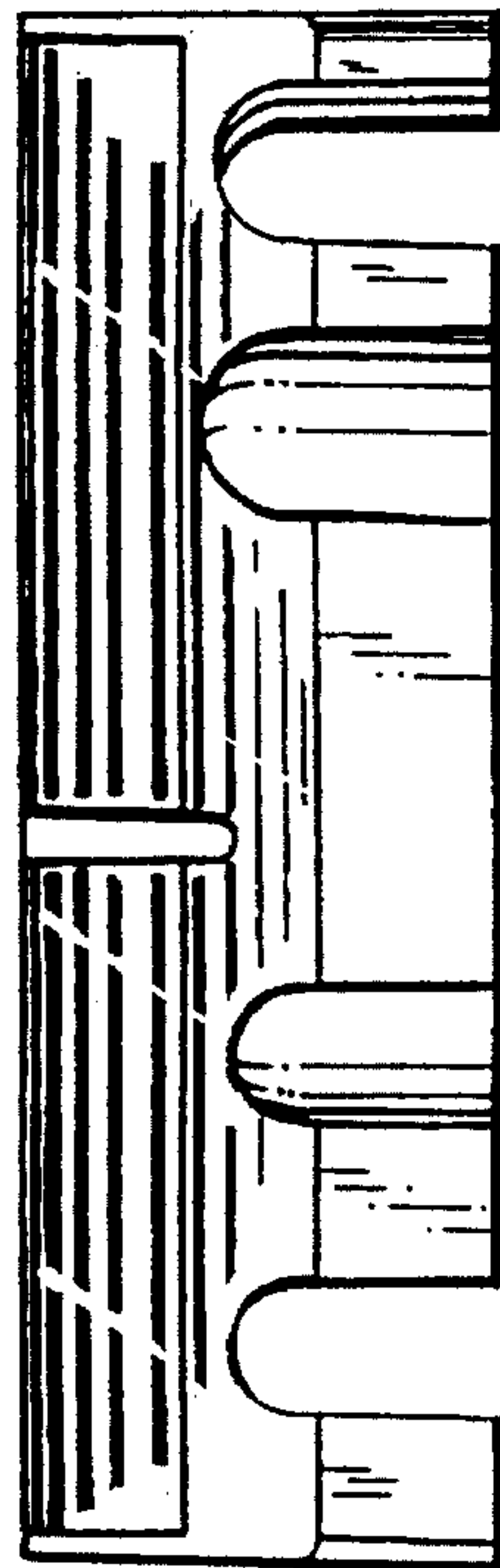

FIG. 5

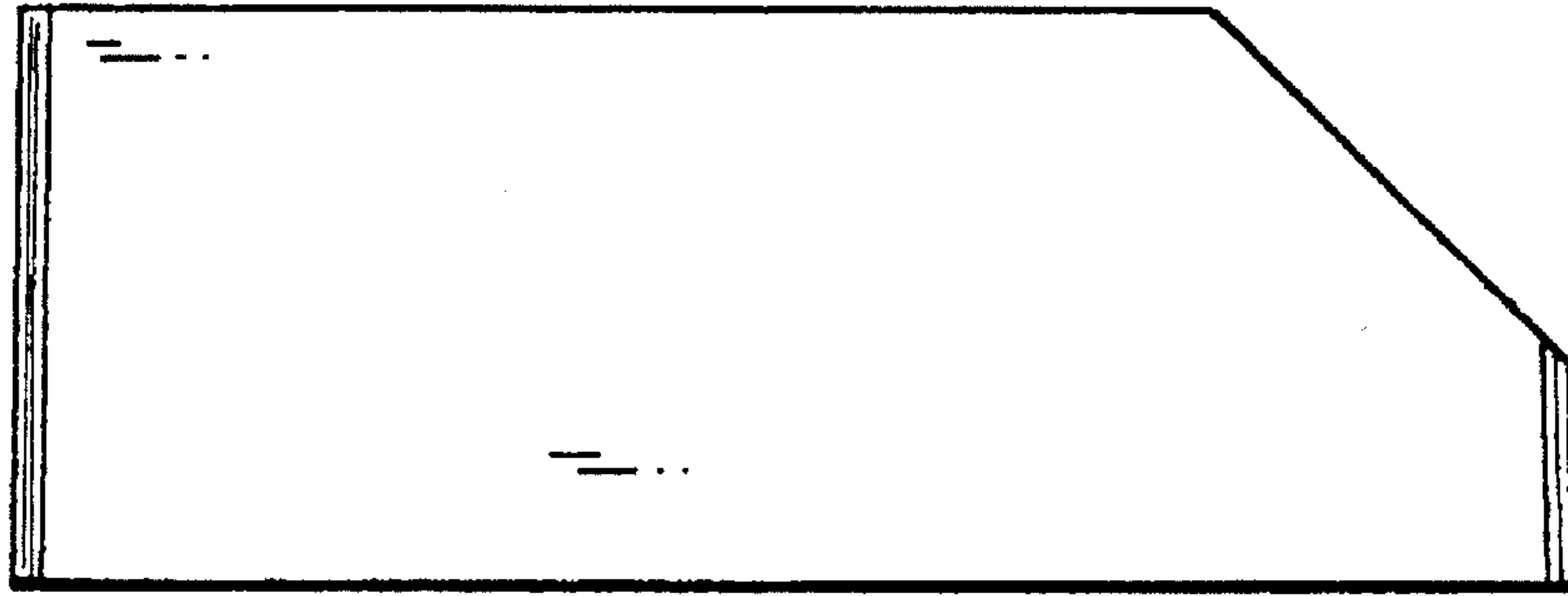

FIG. 3

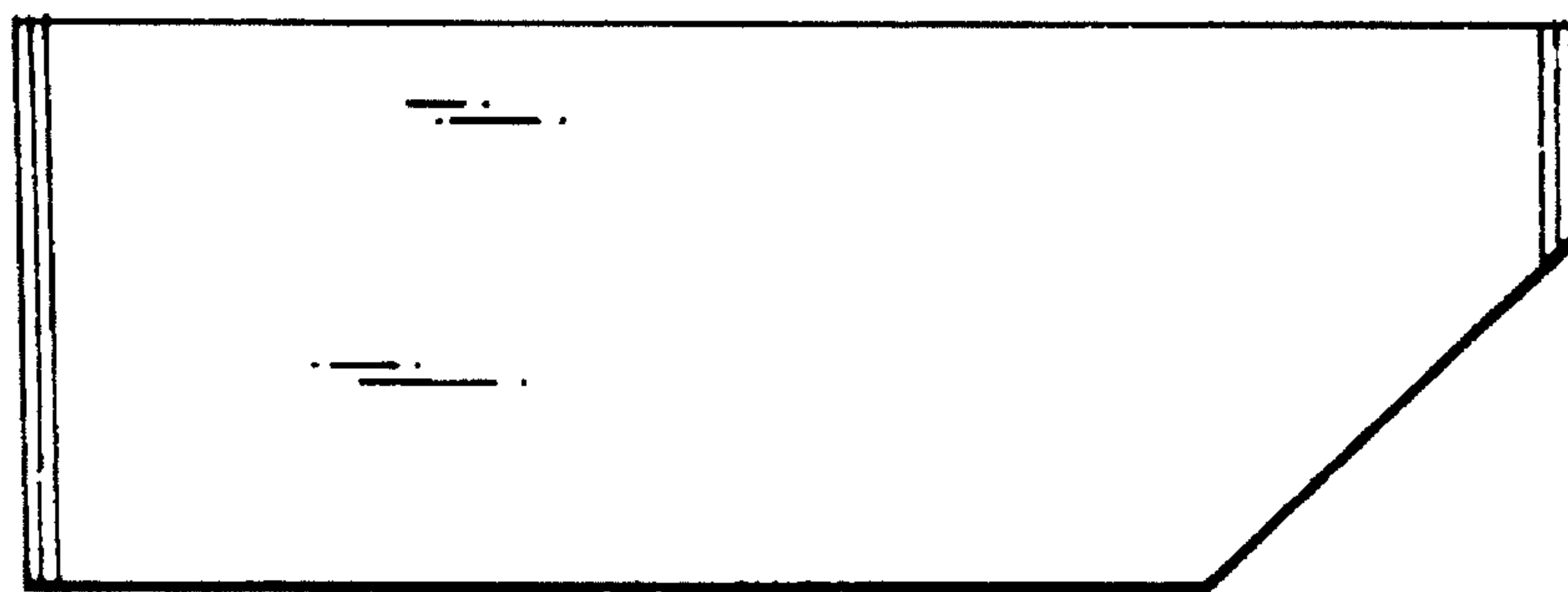

FIG. 4

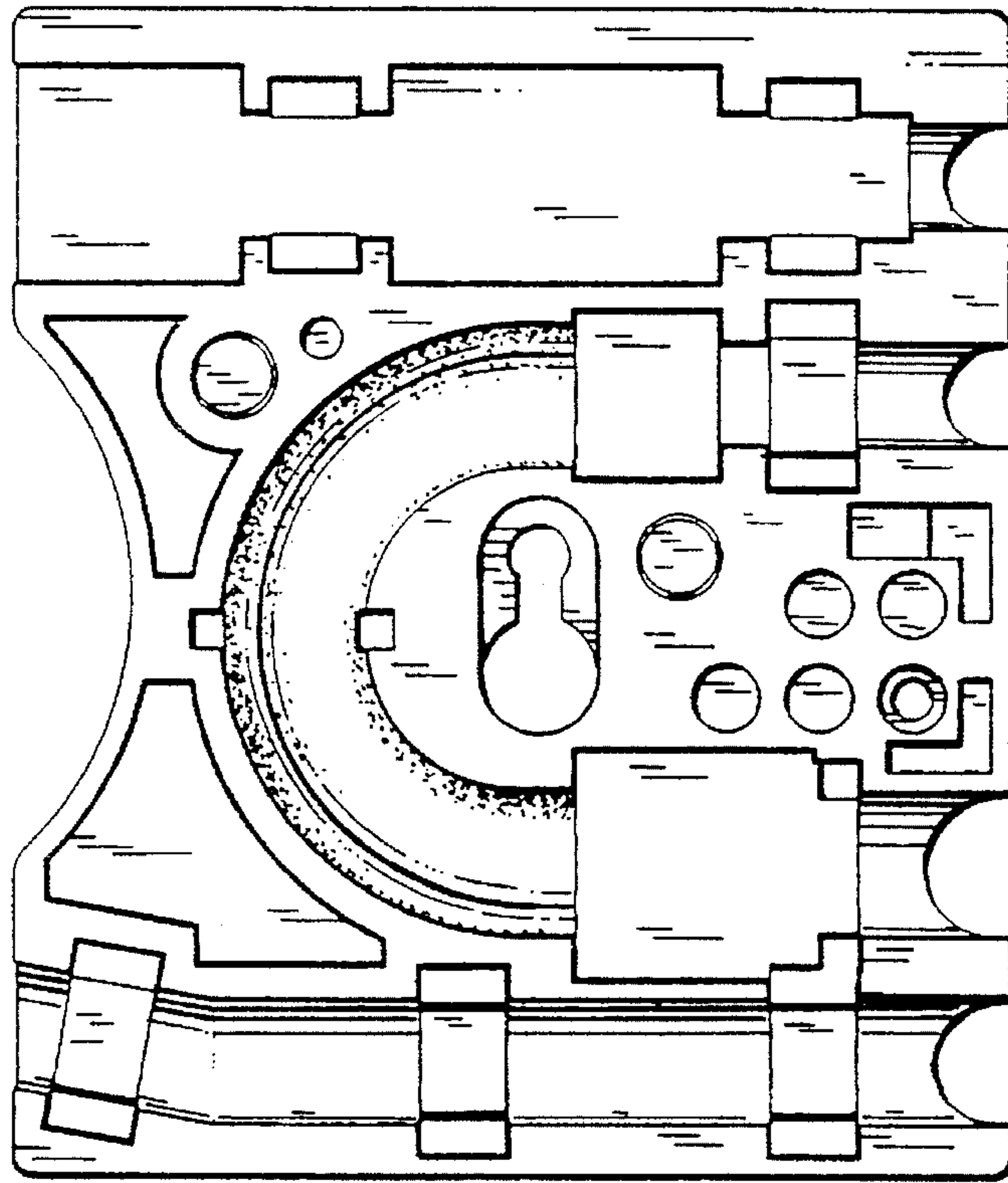

FIG. 7

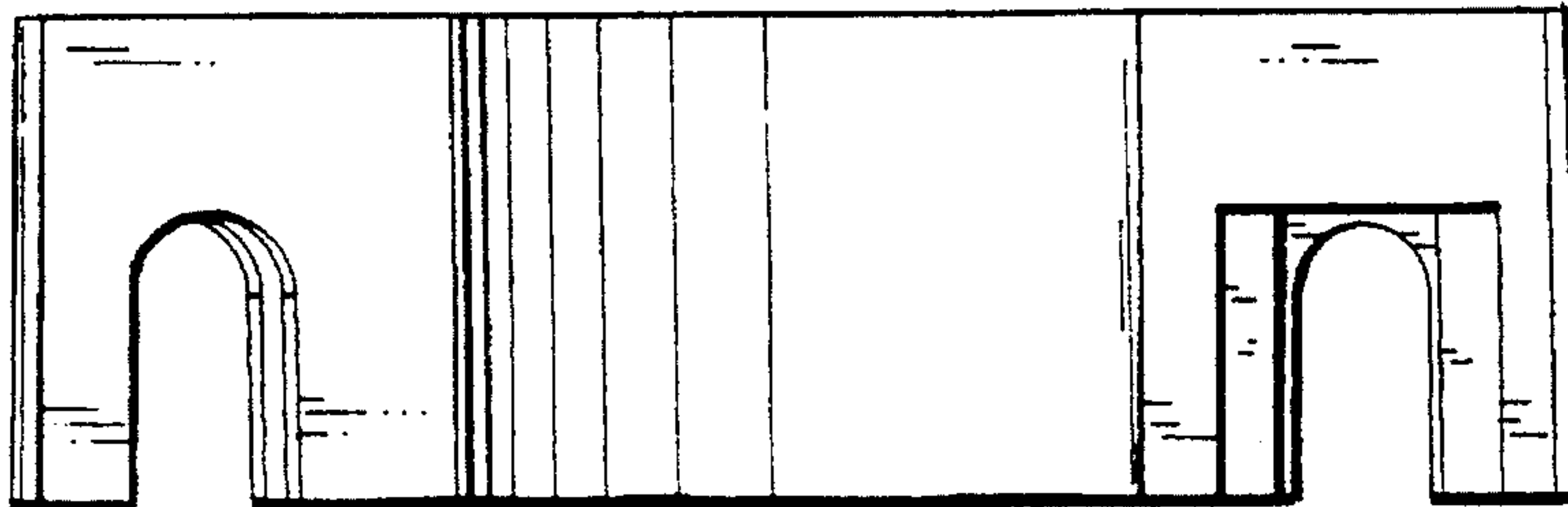

FIG. 6