



US00D367305S

United States Patent [19]
Myers

[11] **Patent Number: Des. 367,305**

[45] **Date of Patent: **Feb. 20, 1996**

[54] **GOLF PUTTER HEAD**

[76] Inventor: **Charles B. Myers**, 299 Barcelona St.,
Punta Gorda, Fla. 33983

[**] Term: **14 Years**

[21] Appl. No.: **26,222**

[22] Filed: **Nov. 10, 1994**

[52] U.S. Cl. **D21/217**

[58] Field of Search **D21/217-219;**
273/167-175

[56] **References Cited**

U.S. PATENT DOCUMENTS

- D. 149,156 3/1948 Weatherington D21/219
- D. 228,776 10/1973 Lee D21/219

Primary Examiner—Ted Shooman
Assistant Examiner—Mitchell I. Siegel

[57] **CLAIM**

The ornamental design of a golf putter head, as shown and described.

DESCRIPTION

FIG. 1 is a perspective view of the rear and top of the putter head;

FIG. 2 is a perspective view of the front and top of the putter head;

FIG. 3 is a rear view of the putter head;

FIG. 4 is a top plan view of the putter head;

FIG. 5 is a bottom plan view of the putter head;

FIG. 6 is a left end view of the putter head; and,

FIG. 7 is a right end view of the putter head.

1 Claim, 6 Drawing Sheets

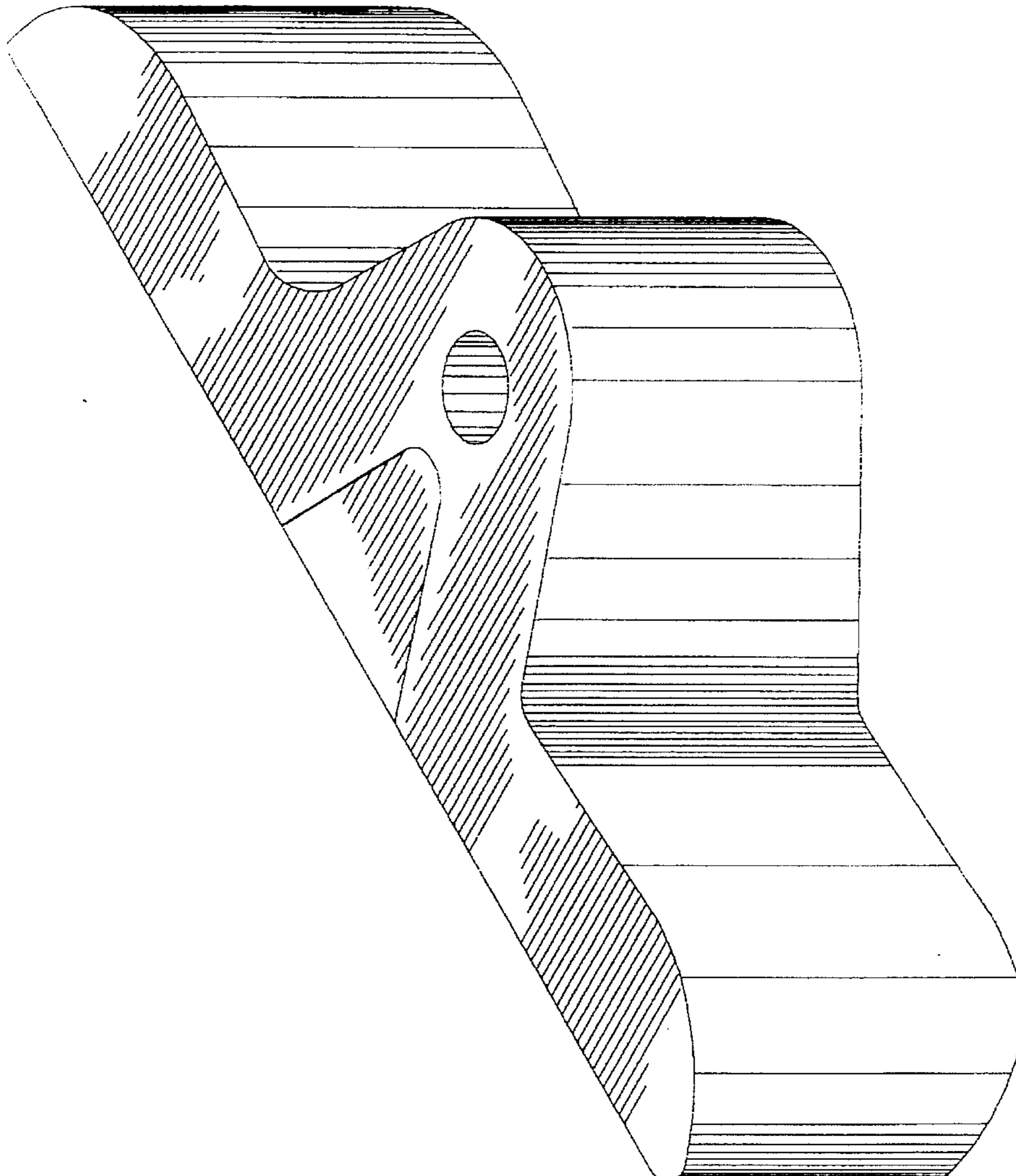

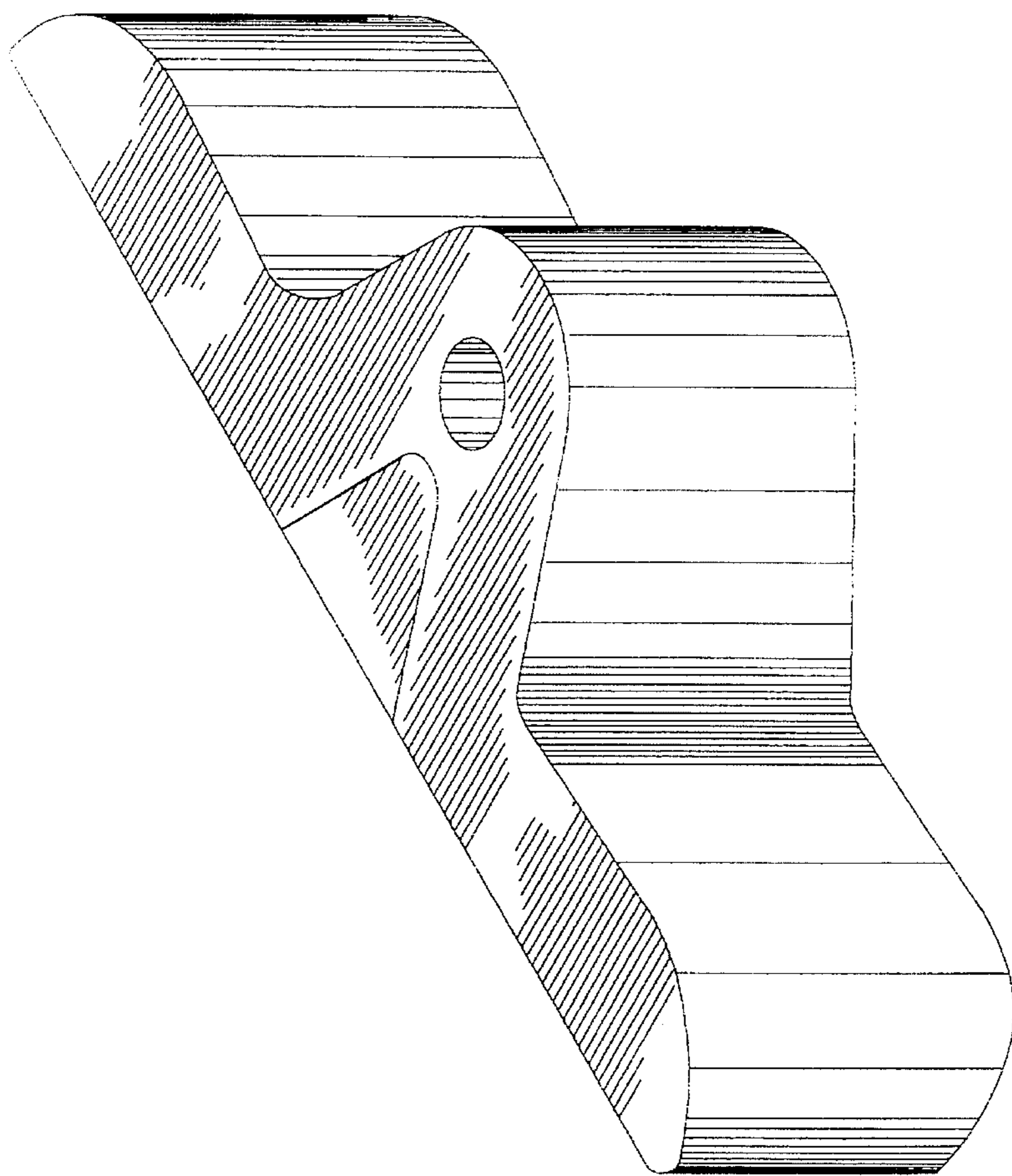

FIG.1

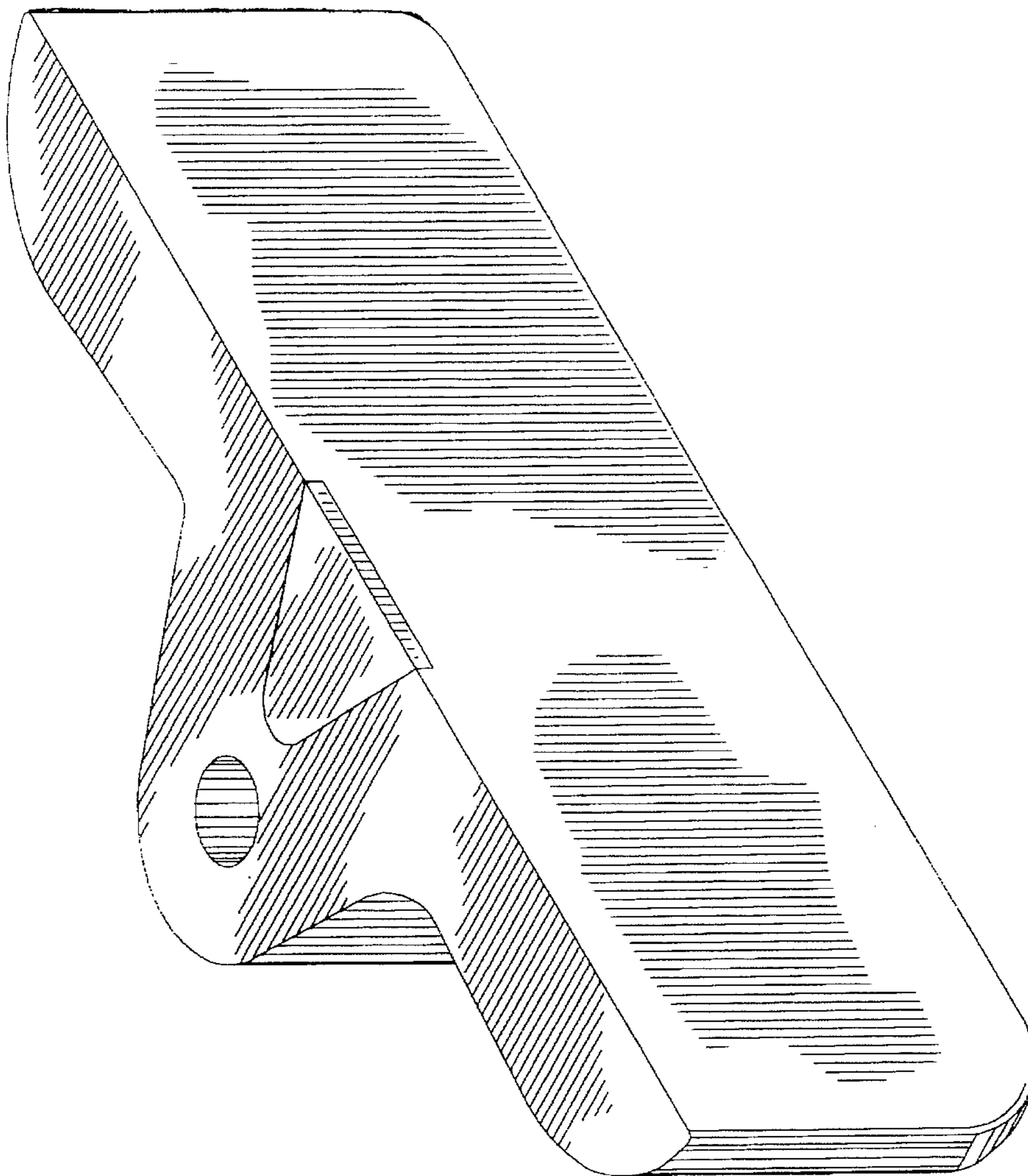

FIG.2

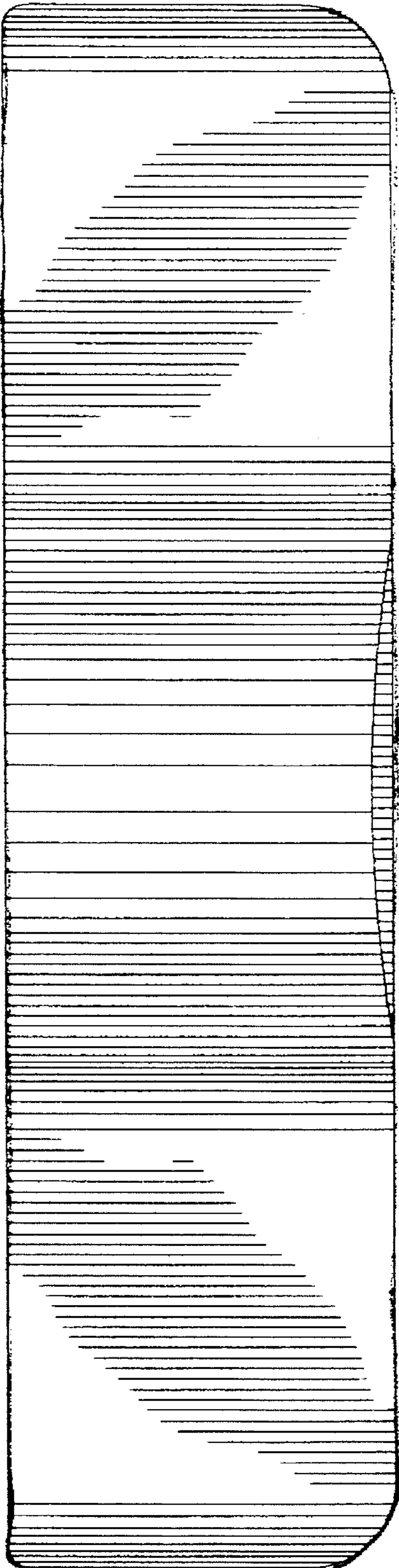

FIG. 3

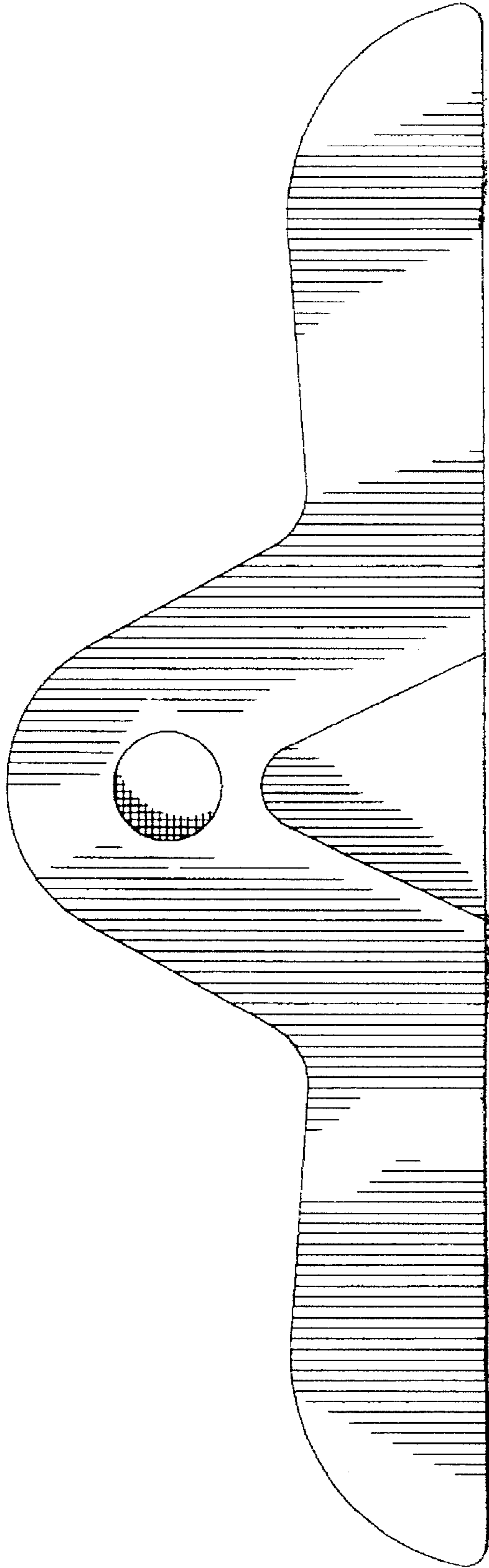

FIG. 4

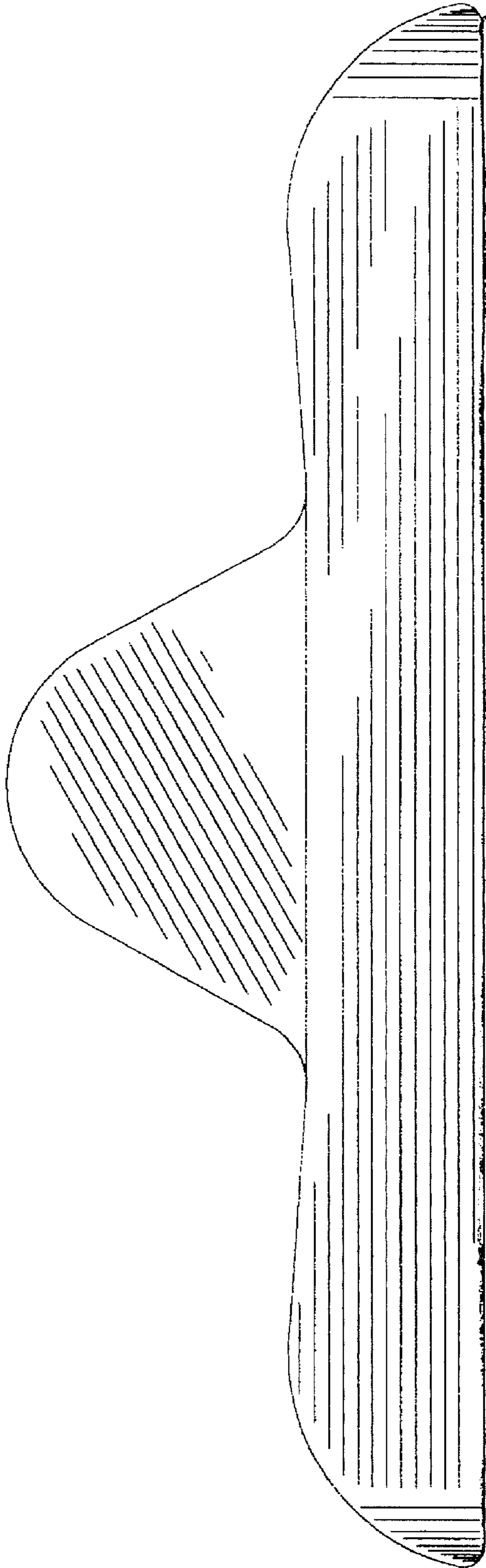

FIG. 5

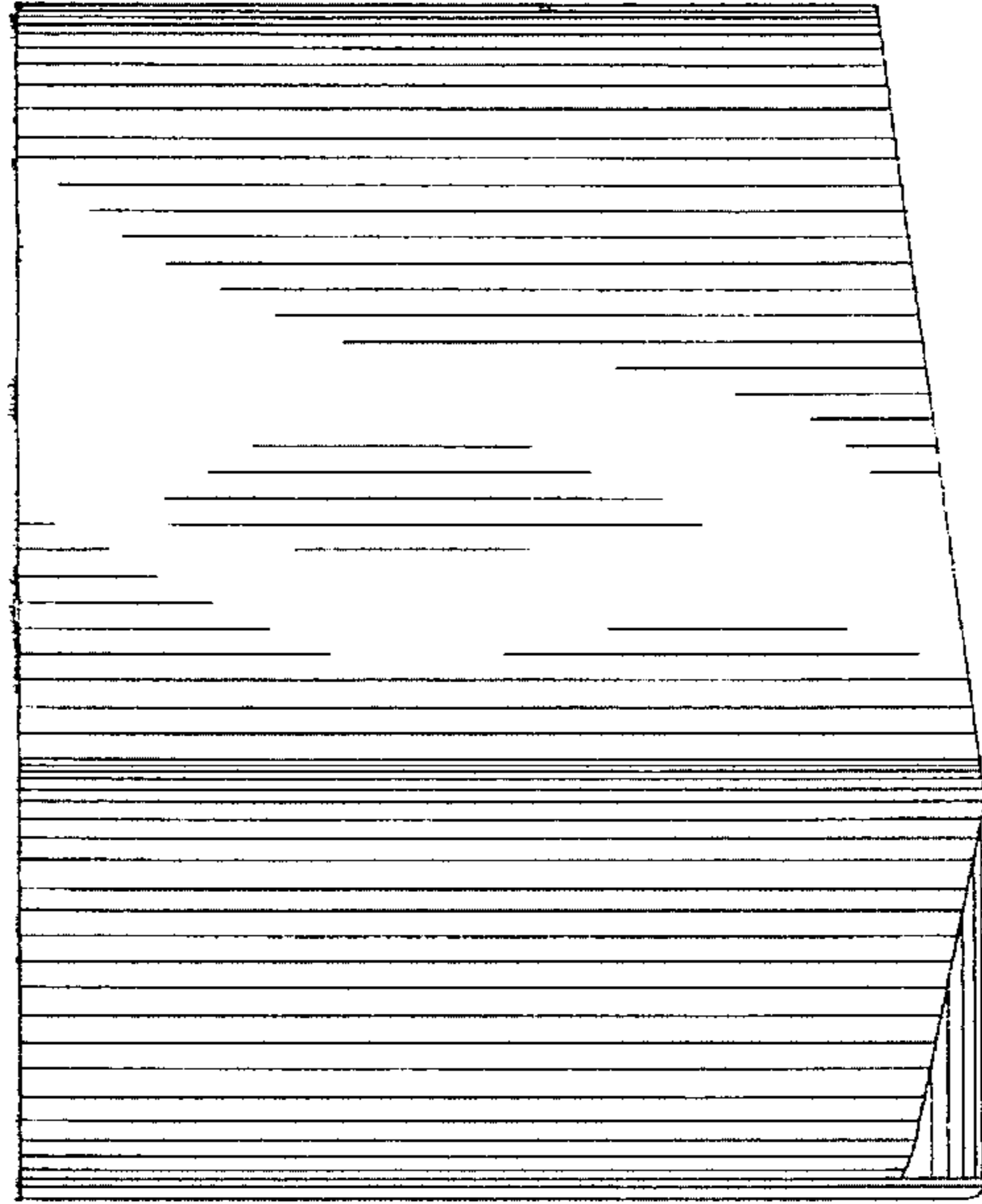

FIG. 7

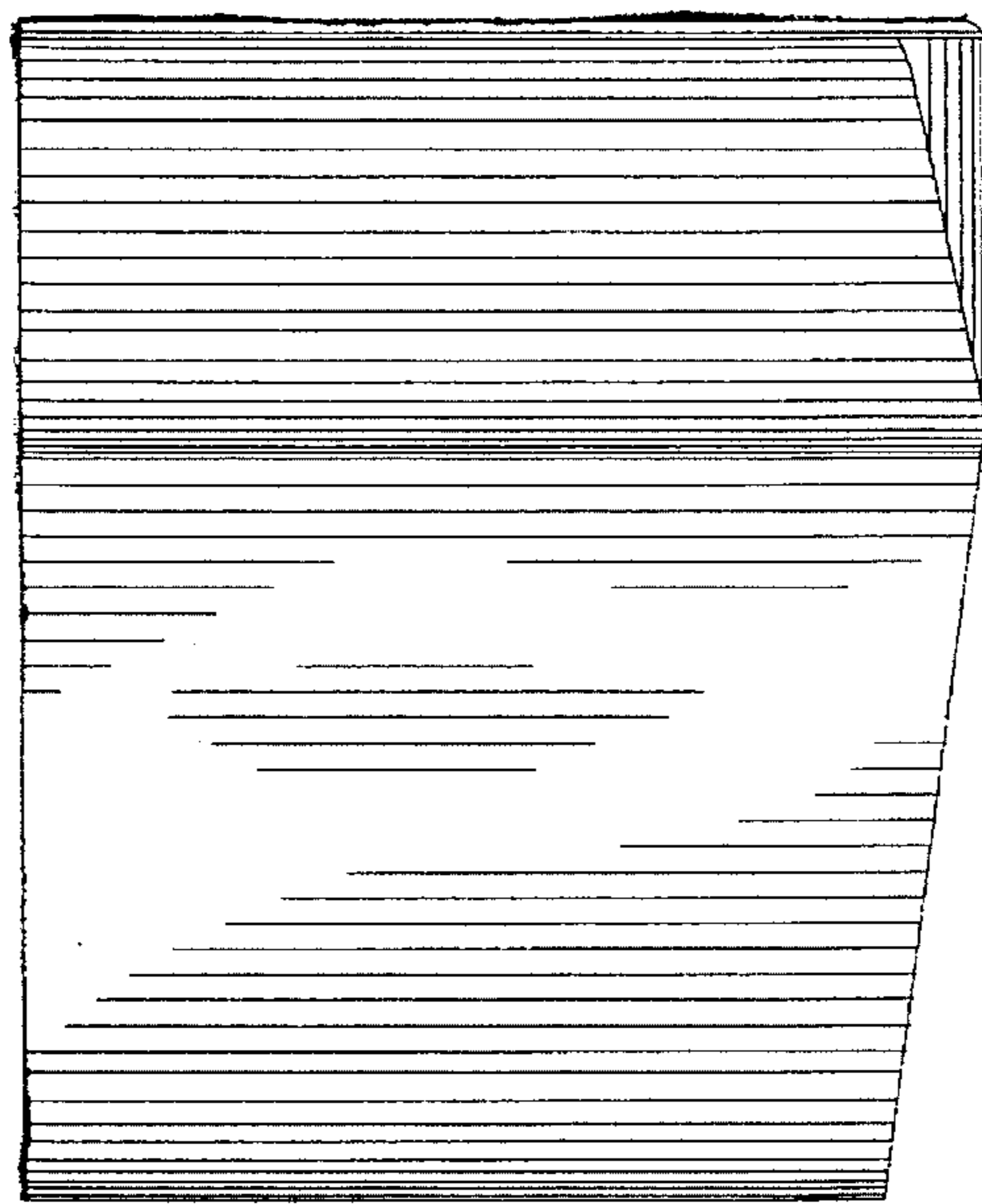

FIG. 6