



US00D367295S

United States Patent [19]
Hsieh

[11] **Patent Number: Des. 367,295**
[45] **Date of Patent: **Feb. 20, 1996**

[54] **JOYSTICK BASE**

[76] **Inventor: Ming-Kun Hsieh**, No. 53, Chungcheng Rd., Hsitzu Chen,, Taipei Hsien, Taiwan

[**] **Term: 14 Years**

[21] **Appl. No.: 38,249**

[22] **Filed: May 2, 1995**

[52] **U.S. Cl. D21/48; D21/13**

[58] **Field of Search D21/1, 13, 48; 273/433-438, 148 B, DIG. 28**

[56] **References Cited**

U.S. PATENT DOCUMENTS

D. 309,161	7/1990	Leung	D21/13
D. 340,748	10/1993	Li	D21/48
D. 343,202	1/1994	Peersmann	D21/13
D. 354,993	1/1995	Morrison et al.	D21/13
5,184,830	2/1993	Okada et al.	273/433
5,259,626	11/1993	Ho	273/148 B X

OTHER PUBLICATIONS

Tiger Software Cat. vol. IV, No. 11, p. 75 Oct. 1994.
HongKong Enterprise, Oct. -1994, p. 245.

Primary Examiner—Prabhakar G. Deshmukh
Attorney, Agent, or Firm—Ross, Clapp, Korn & Montgomery

[57] **CLAIM**

The ornamental design for a joystick base, as shown and described.

DESCRIPTION

FIG. 1 is a front-right-top perspective view of a joystick base, showing my new design;
FIG. 2 is a front view thereof, the opposite side view being a mirror image;
FIG. 3 is a left side view thereof;
FIG. 4 is a right side view thereof;
FIG. 5 is a top view thereof; and,
FIG. 6 is a bottom view thereof.

1 Claim, 3 Drawing Sheets

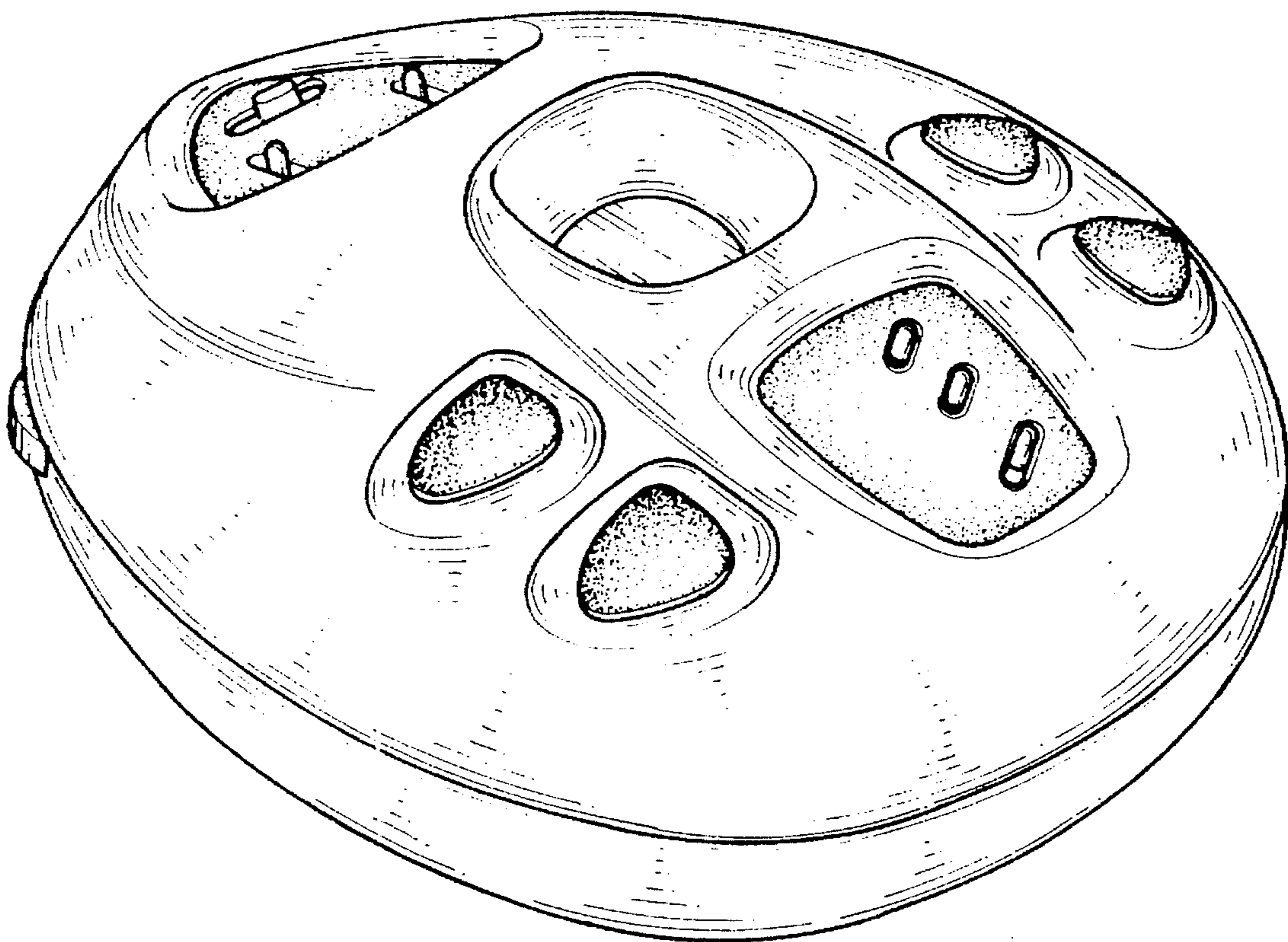

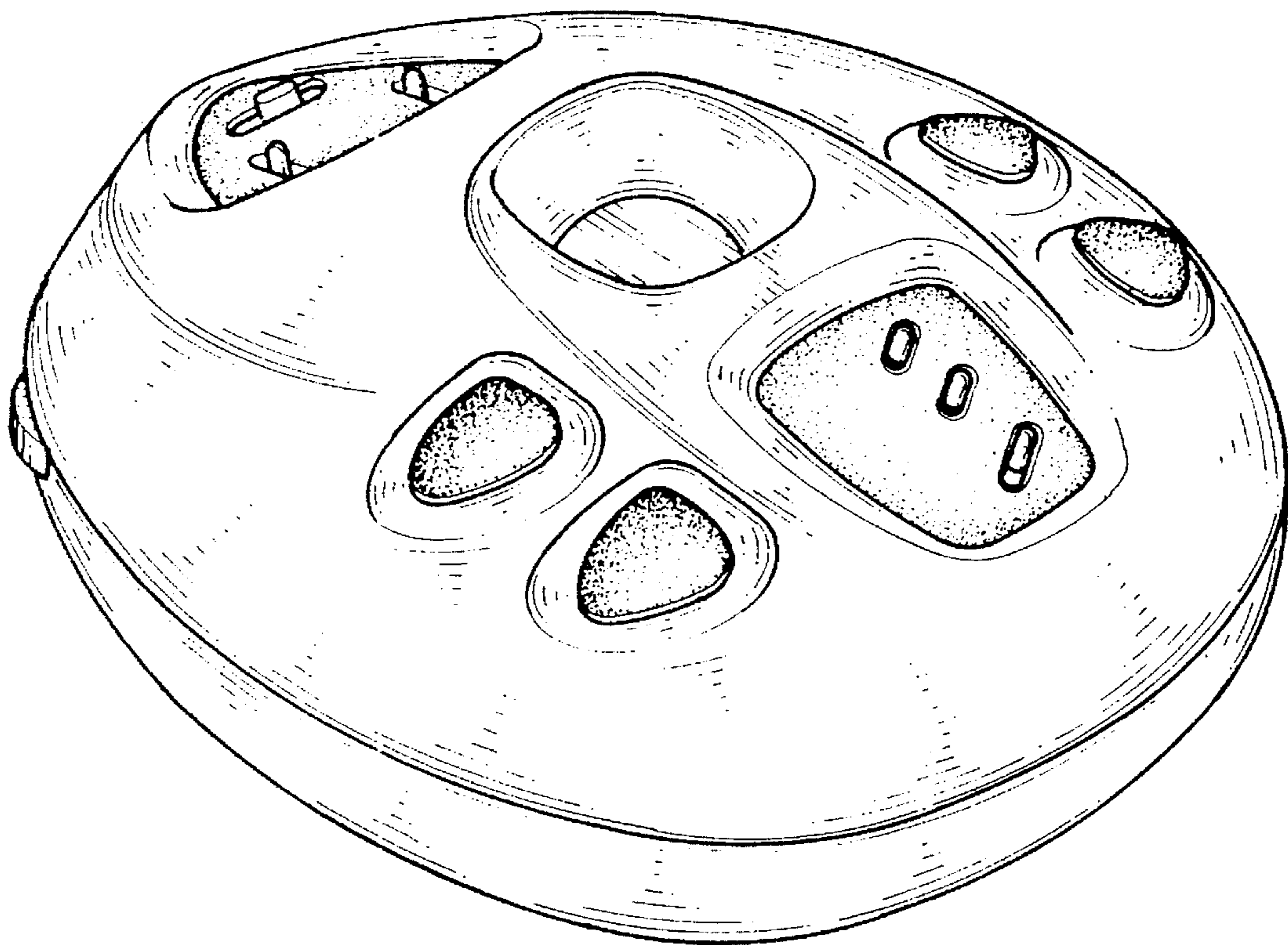

FIG. 1

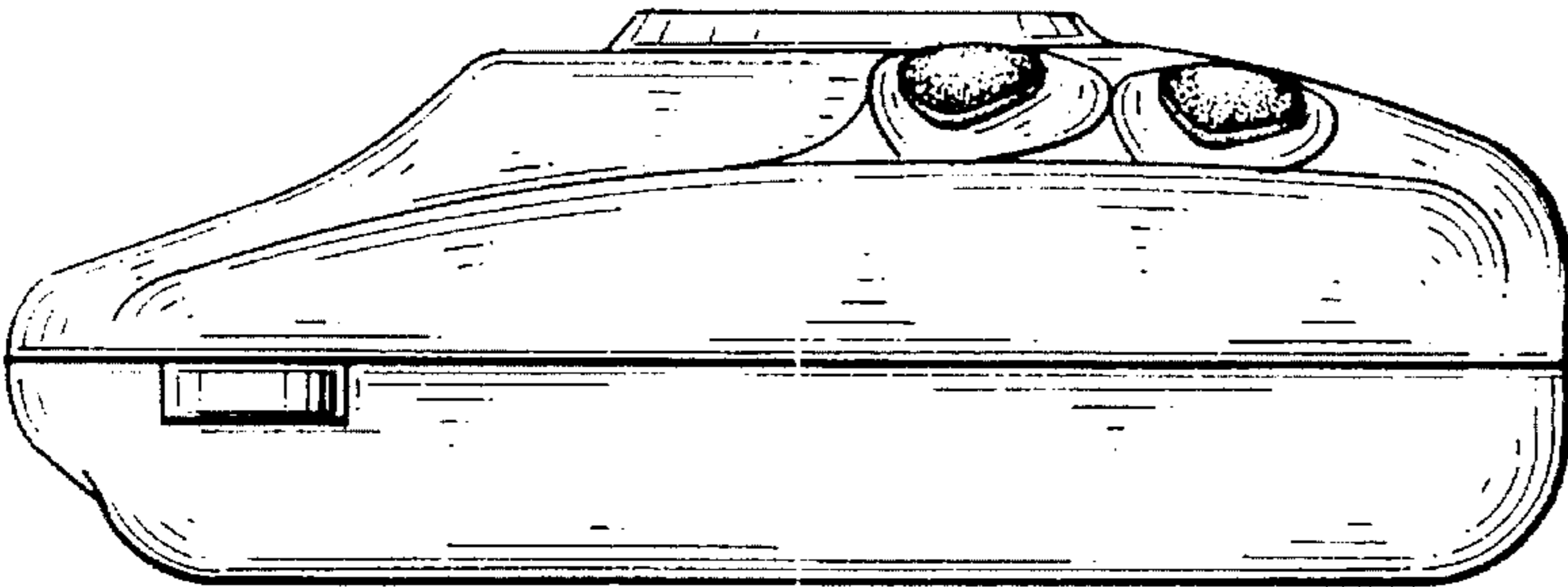

FIG. 2

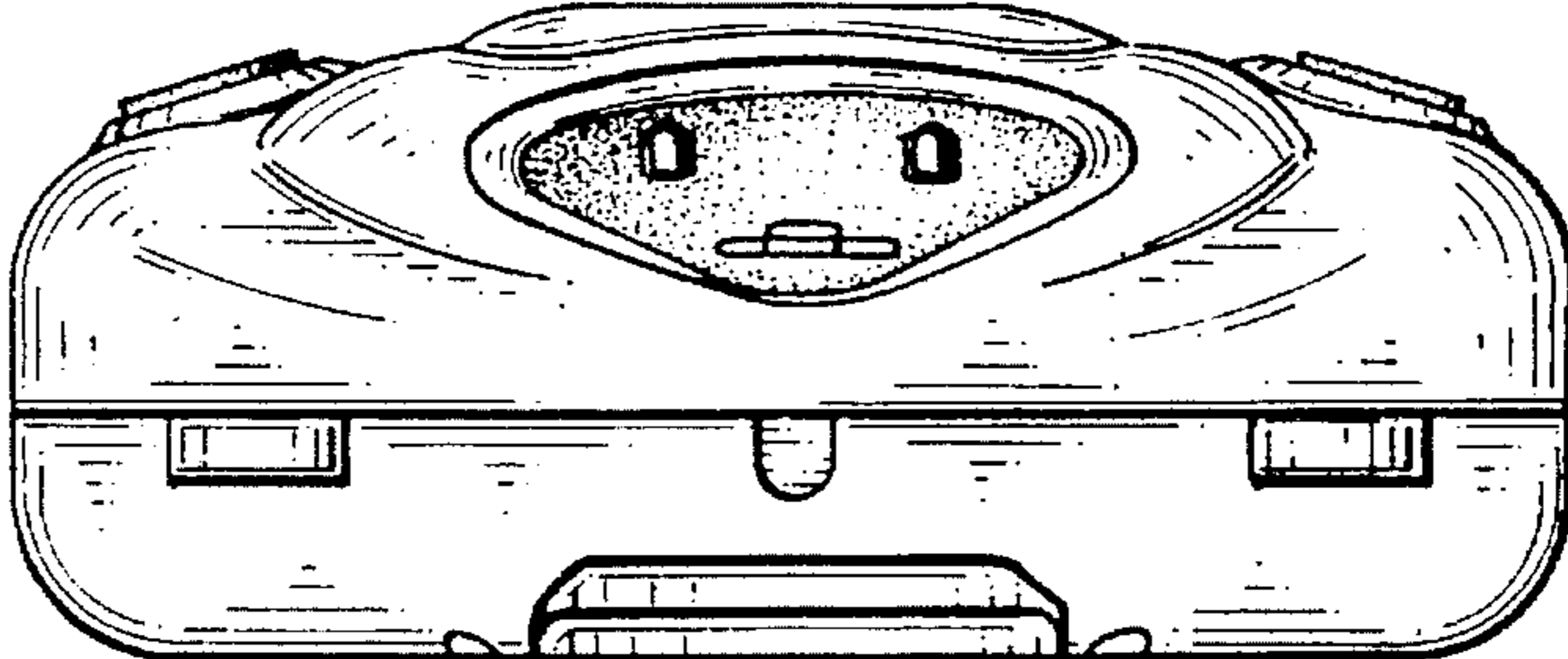

FIG. 3

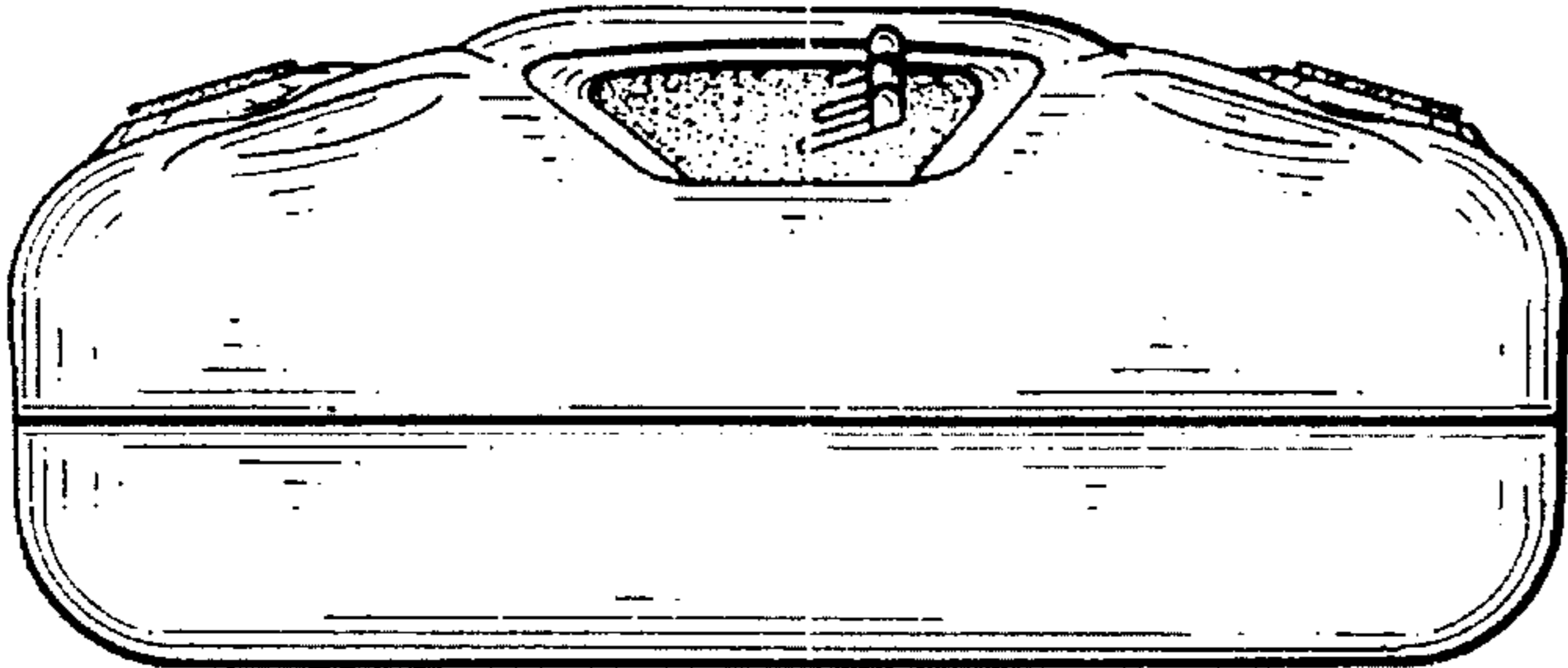

FIG. 4

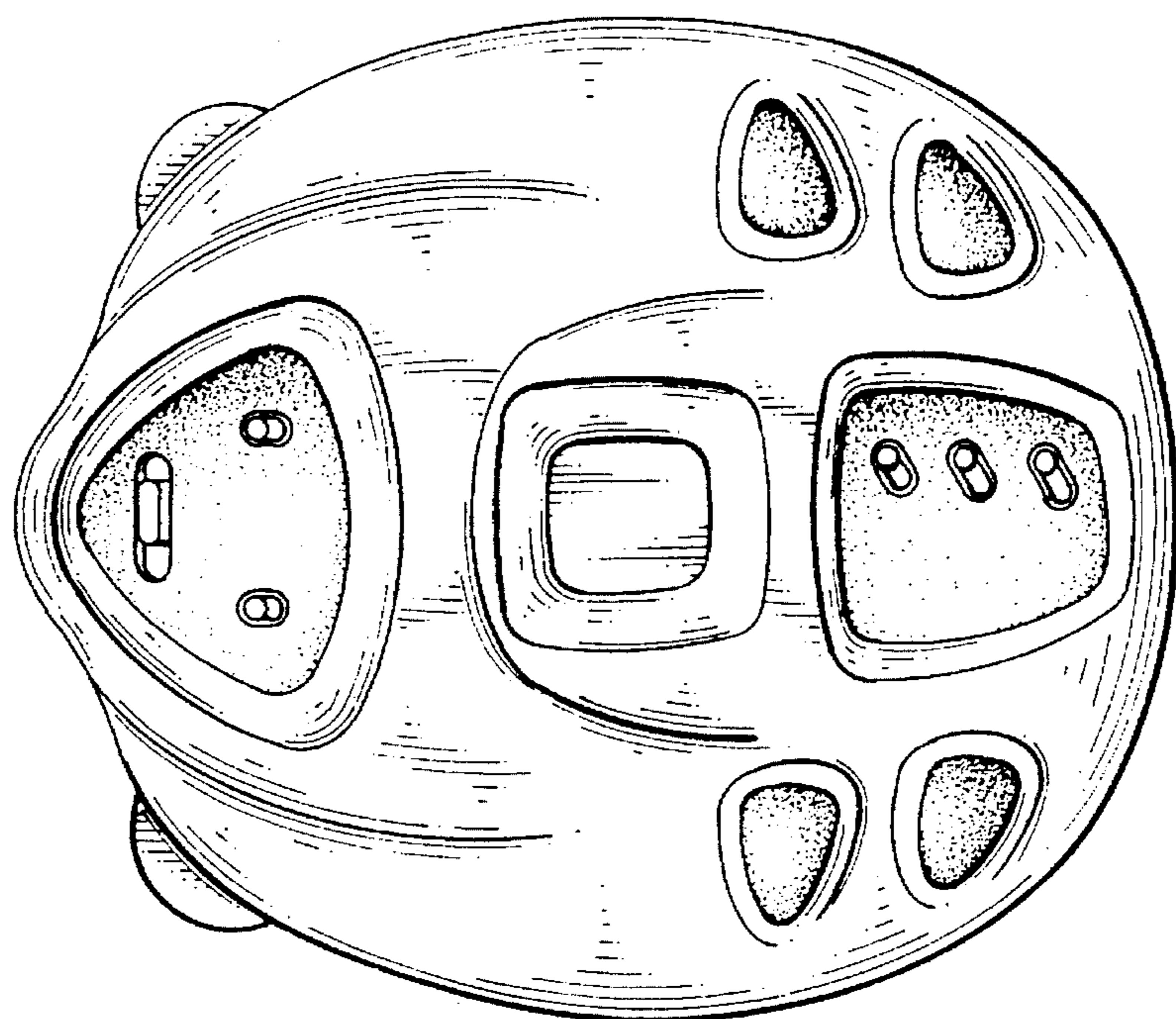

FIG. 5

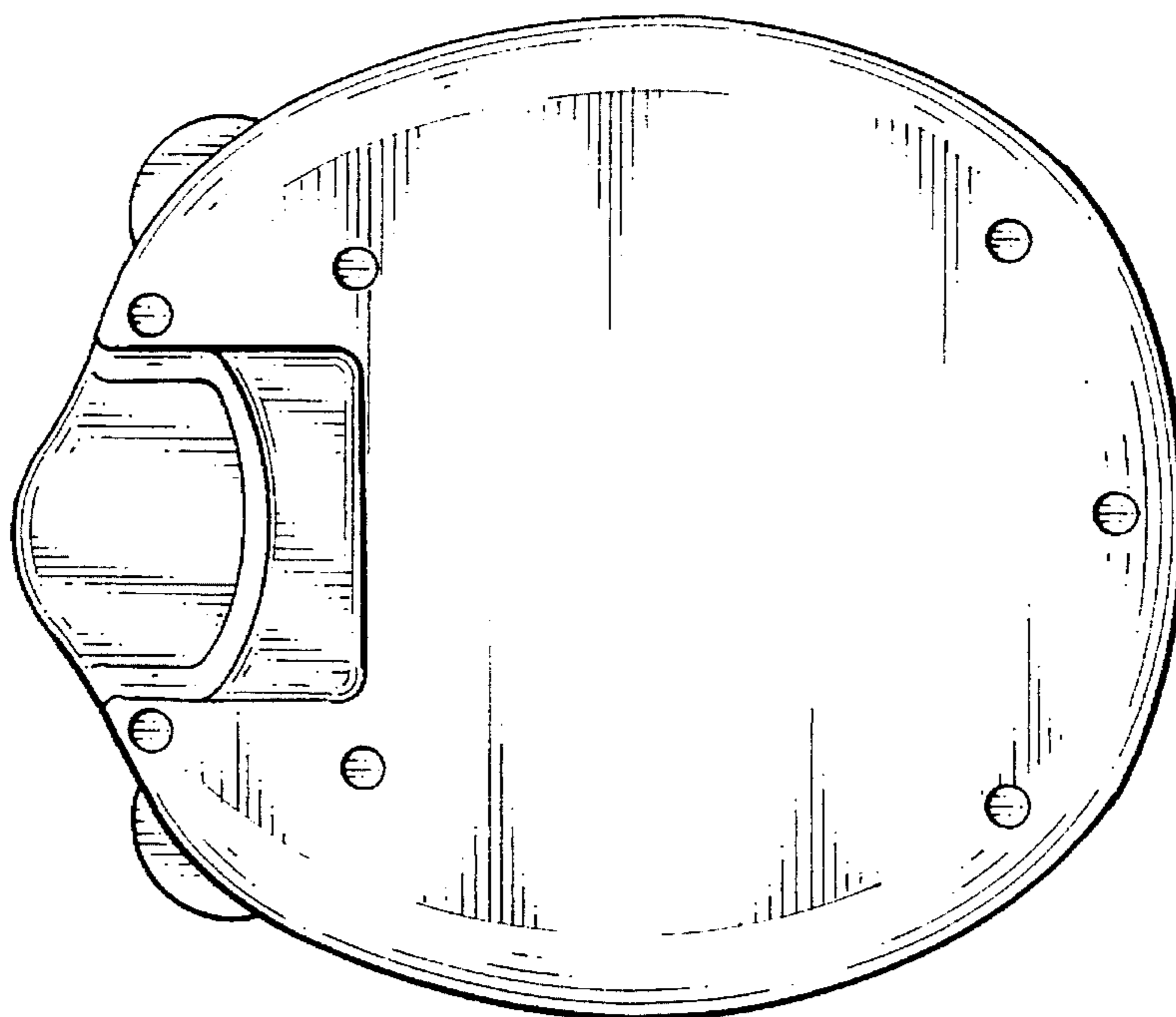

FIG. 6