



US00D367284S

# United States Patent [19]

[11] Patent Number: **Des. 367,284**

**Hoerter**

[45] Date of Patent: **\*\*Feb. 20, 1996**

[54] **COMBINED BOW QUIVER AND CAMERA MOUNT MOUNT**

3,465,928 9/1969 Osterholm ..... 224/916  
4,296,725 10/1981 Broderick ..... 124/23.1

[76] Inventor: **Todd A. Hoerter**, 175 Desplaines St., Coal City, Ill. 60416

*Primary Examiner*—Prabhakar G. Deshmukh  
*Assistant Examiner*—Adir Aronovich

[\*\*] Term: **14 Years**

[57] **CLAIM**

[21] Appl. No.: **31,771**

The ornamental design for a combined bow quiver and camera mount, as shown and described.

[22] Filed: **Dec. 6, 1994**

**DESCRIPTION**

[52] U.S. Cl. .... **D16/242**; D22/107; D22/199

[58] Field of Search ..... D16/242, 243,  
D16/237; D22/107; 224/916; 248/177;  
354/81, 82

FIG. 1 is a front elevational view of the combined bow quiver and camera mount showing my new design;  
FIG. 2 is a rear elevational view thereof;  
FIG. 3 is a left side elevational view thereof;  
FIG. 4 is a right side elevational view thereof;  
FIG. 5 is a top plan view thereof;  
FIG. 6 is a bottom plan view thereof; and,  
FIG. 7 is an isometric view thereof.

[56] **References Cited**

**U.S. PATENT DOCUMENTS**

D. 248,040	5/1978	Stinson .....	D22/107
D. 308,389	6/1990	Horn et al. ....	D16/242
D. 355,665	2/1995	Omi .....	D16/242

**1 Claim, 4 Drawing Sheets**

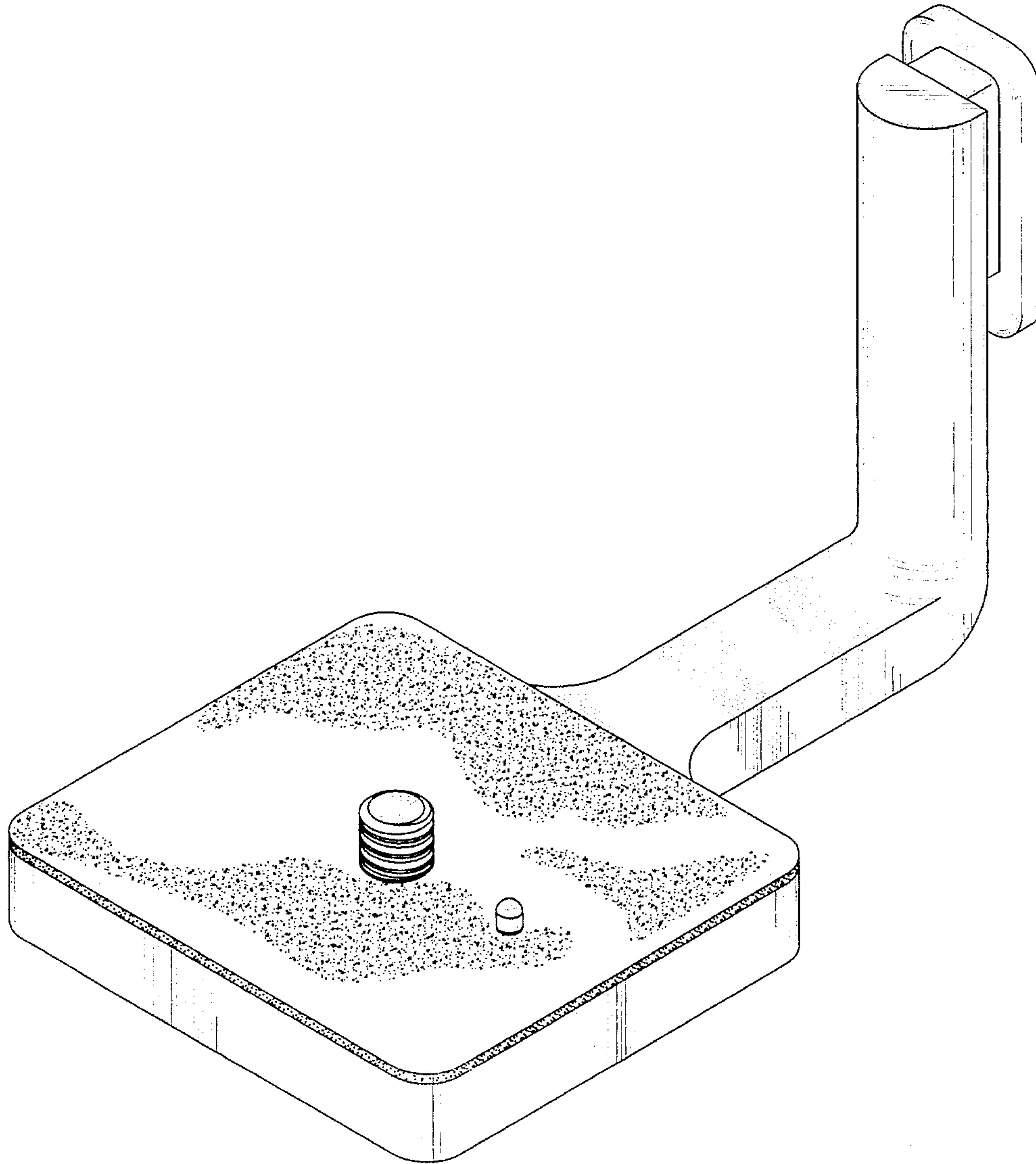

FIG. 1

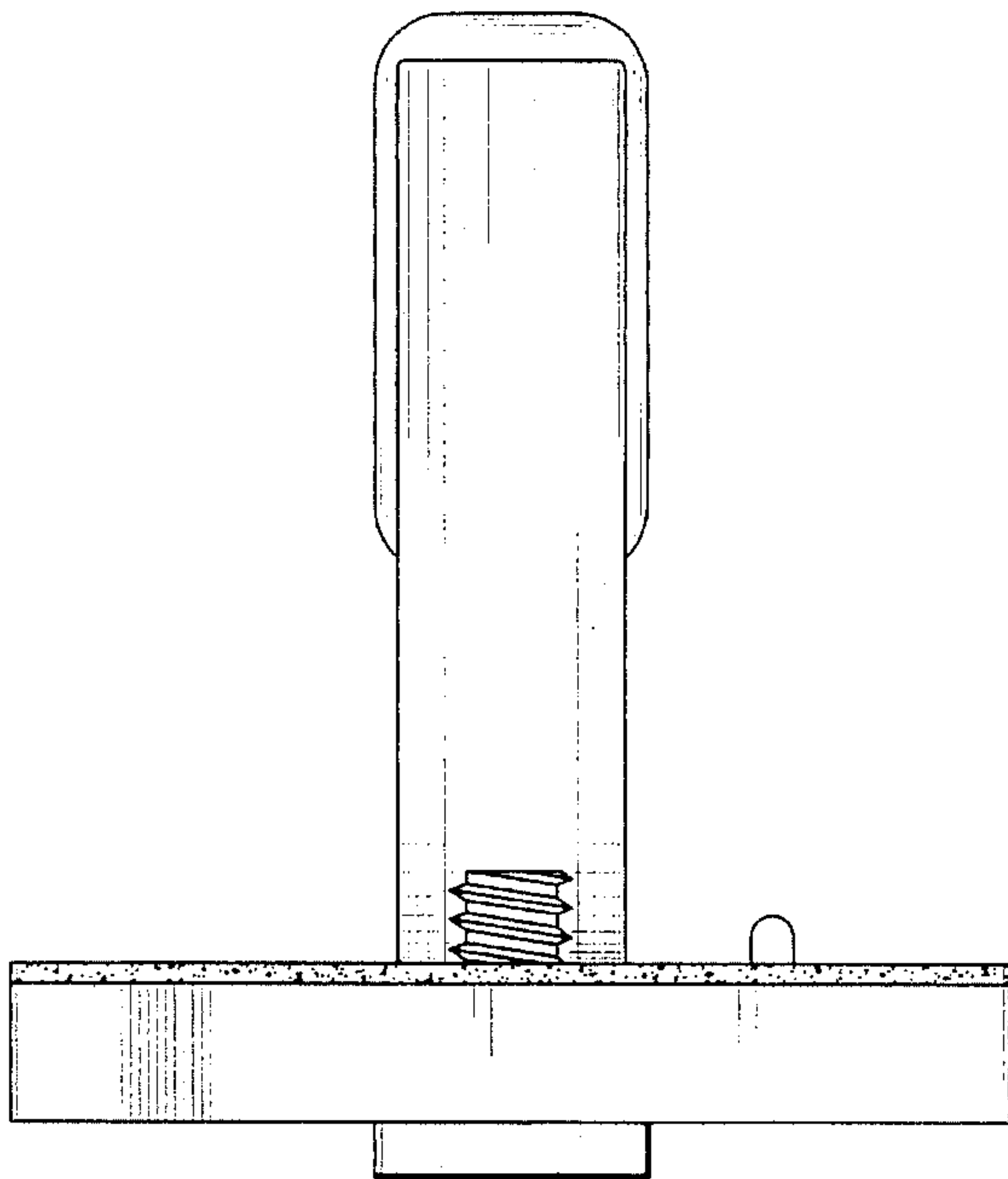

FIG. 2

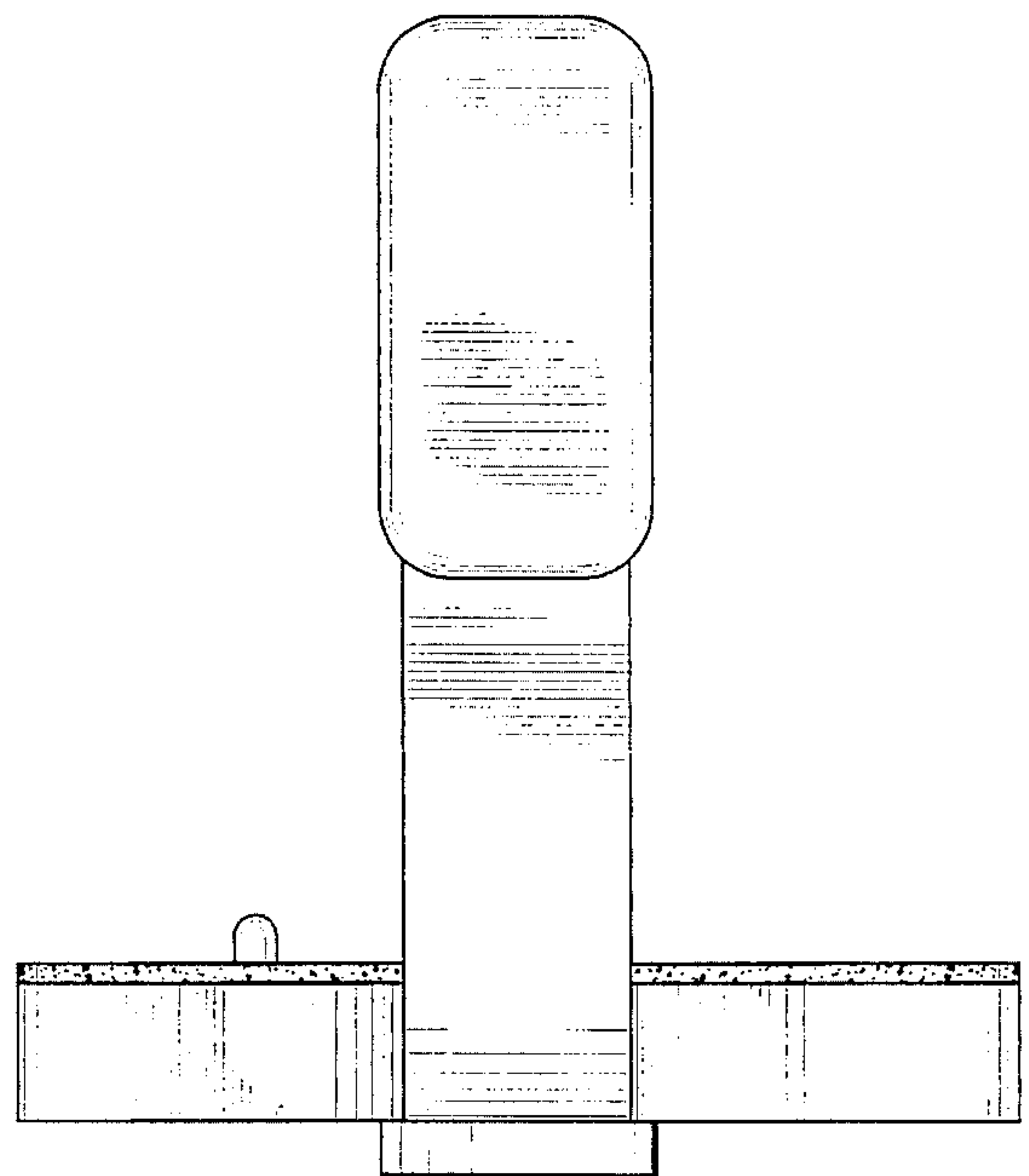

FIG. 3

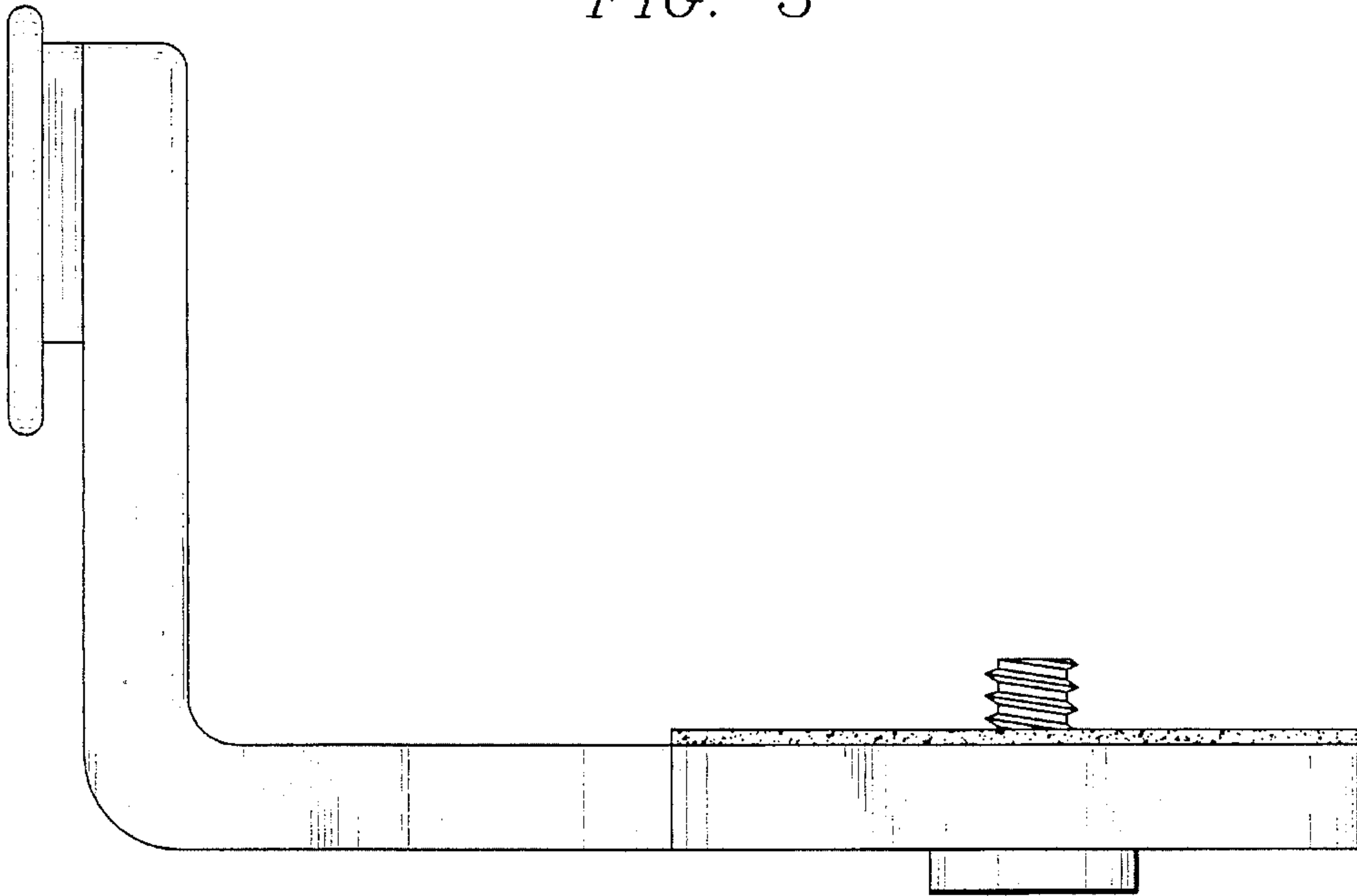

FIG. 4

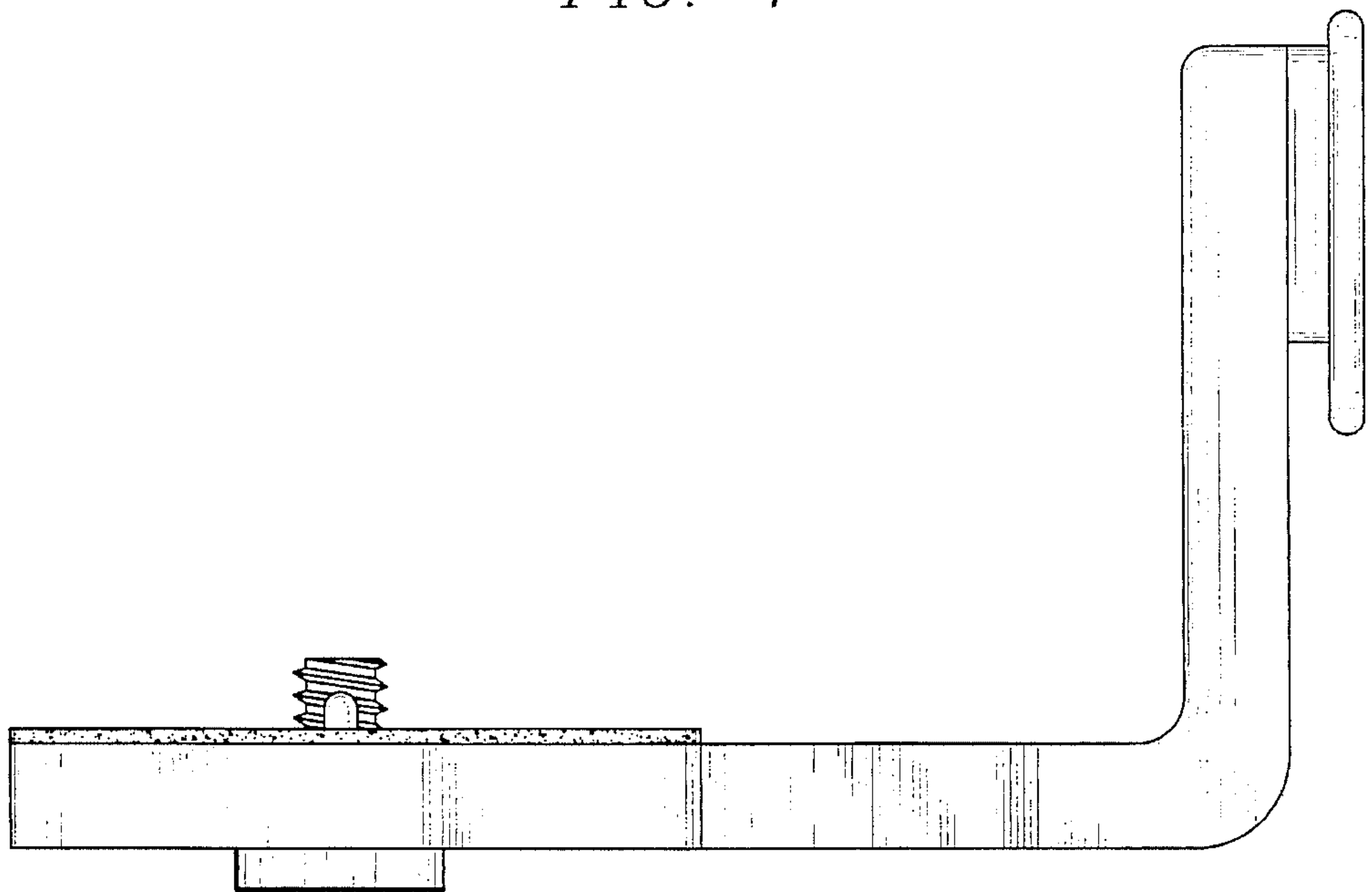

FIG. 5

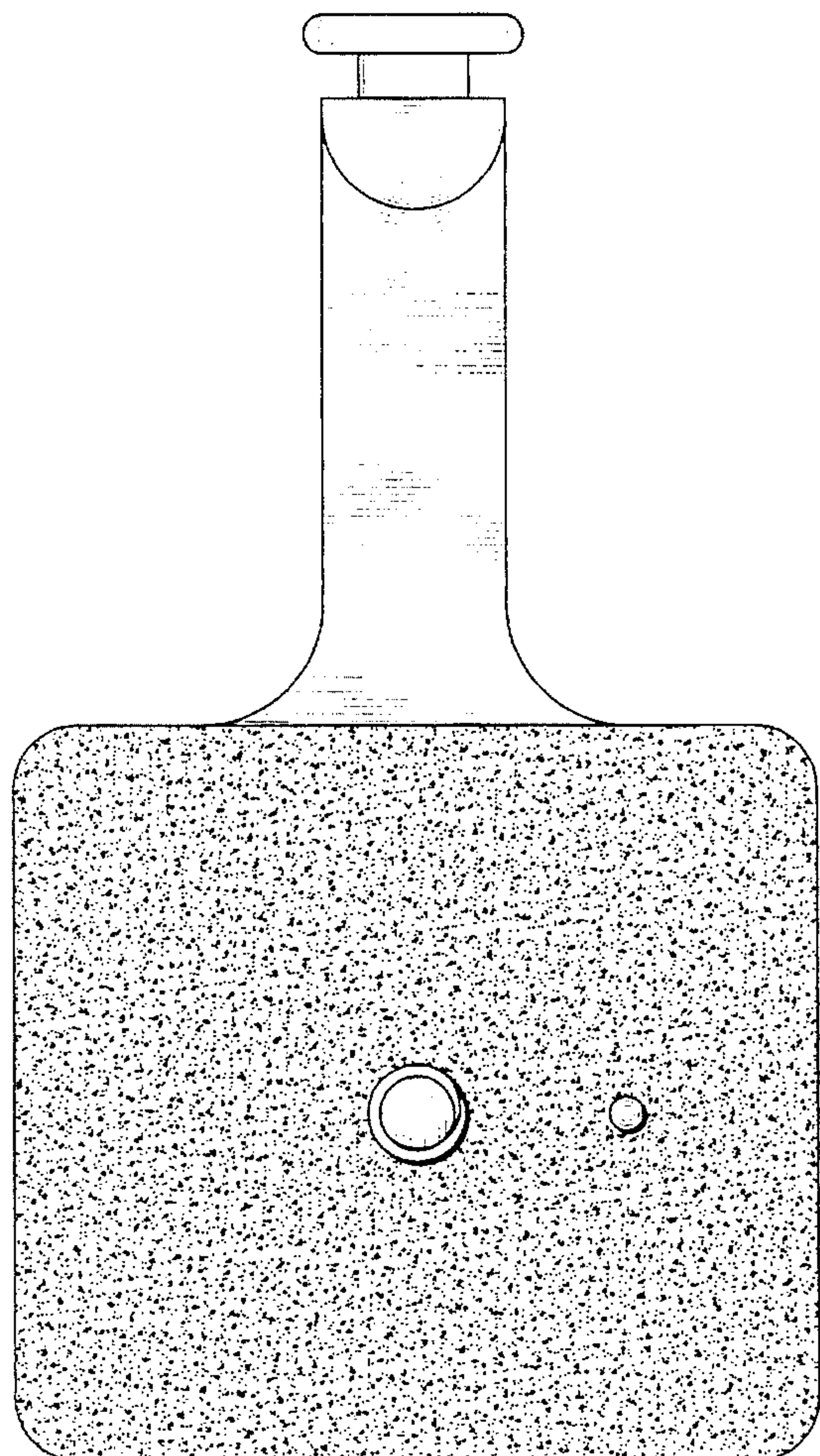

FIG. 6

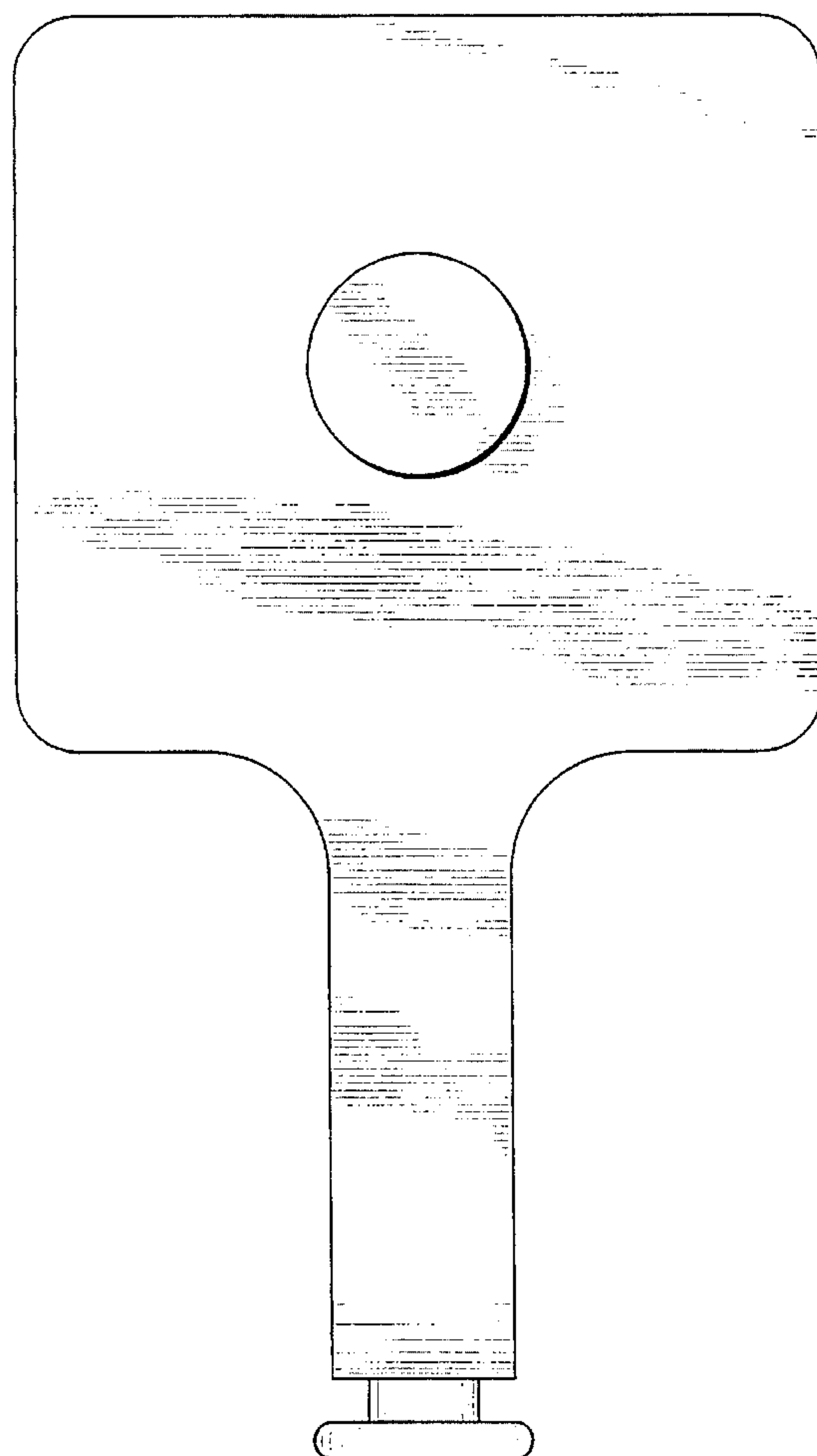



FIG. 7

