



US00D367250S

United States Patent [19]
Kartchner

[11] **Patent Number: Des. 367,250**
[45] **Date of Patent: **Feb. 20, 1996**

[54] **CHAIN GUARD**

2,492,879 12/1949 Mueller D12/127
4,908,008 3/1990 Gorski 474/146

[76] Inventor: **Niles R. Kartchner**, 2622 SW. Temple,
Salt Lake City, Utah 84115

Primary Examiner—Melody N. Brown
Attorney, Agent, or Firm—Foster & Foster; Lynn G. Foster

[**] Term: **14 Years**

[57] **CLAIM**

[21] Appl. No.: **35,270**

The ornamental design for a chain guard, as shown.

[22] Filed: **Feb. 23, 1995**

DESCRIPTION

[52] U.S. Cl. **D12/127**

[58] **Field of Search** D12/127; 74/558.5,
74/608, 611; 174/146, 147; 301/37 P, 37 SS;
280/304.3

FIG. 1 is a perspective of a chain guard embodying my new design;

FIG. 2 is a front elevational view thereof;

FIG. 3 is a top plan view thereof;

FIG. 4 is a rear elevational view thereof;

FIG. 5 is a bottom plan view thereof;

FIG. 6 is a side elevational view as seen from the right side; and,

FIG. 7 is a side elevation view as seen from the left side.

[56] **References Cited**

U.S. PATENT DOCUMENTS

- D. 107,442 12/1937 Morgan D12/127
- D. 214,979 8/1969 Schreckengost D12/127
- D. 248,034 5/1978 Williams et al. D12/127
- D. 251,188 2/1979 Patterson et al. D12/127
- D. 355,872 2/1995 Haney et al. D12/127

1 Claim, 2 Drawing Sheets

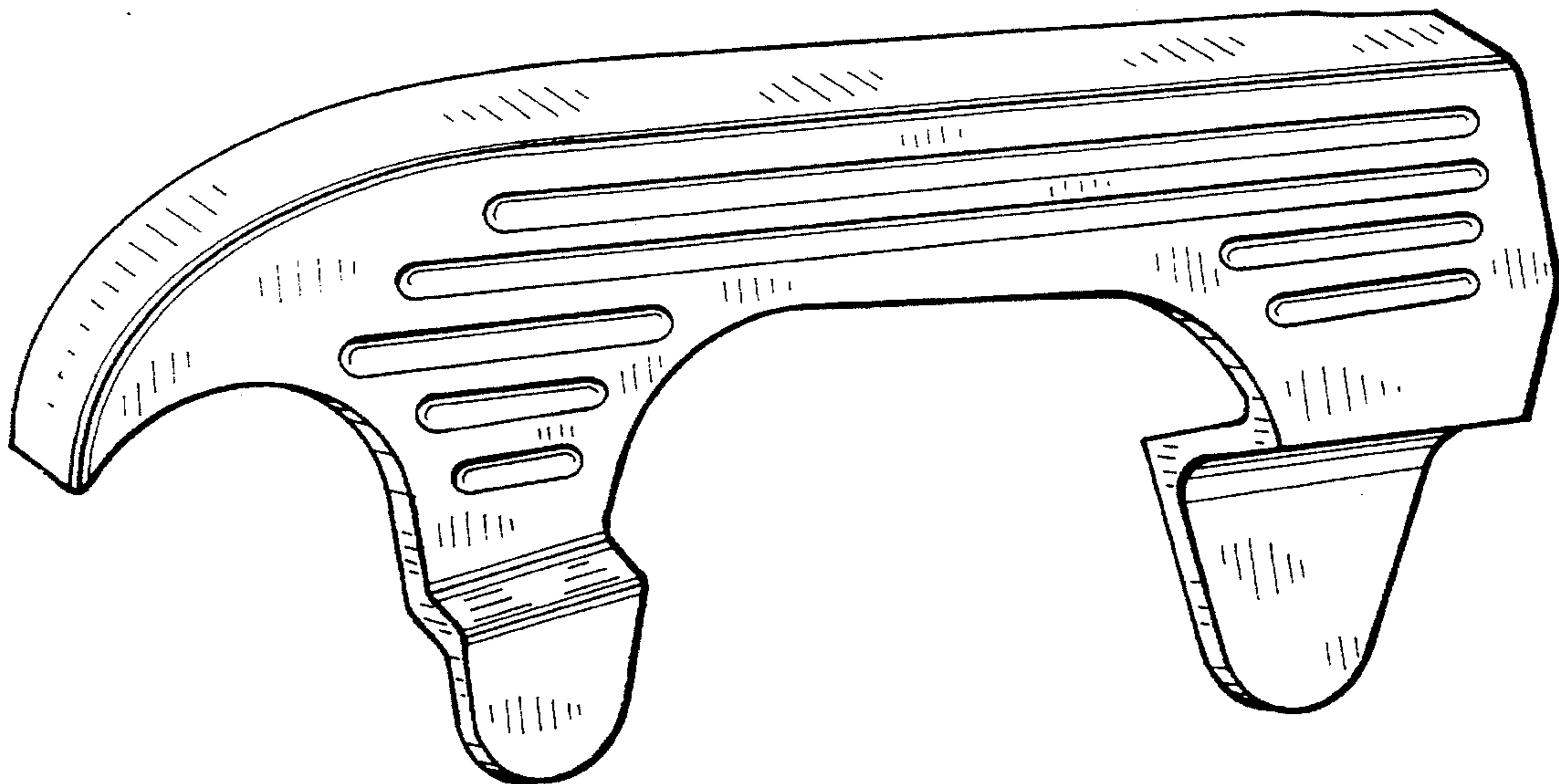

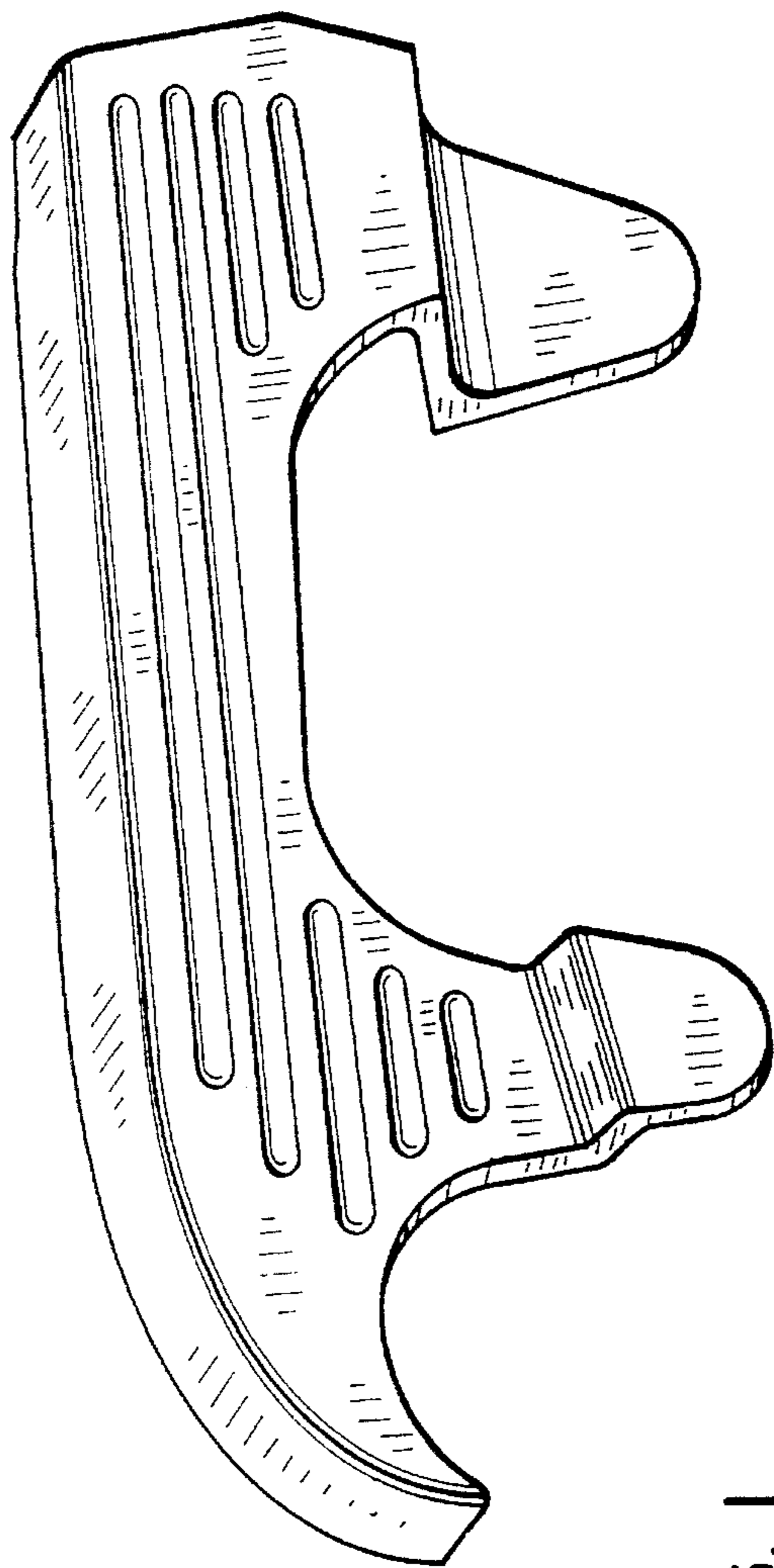

FIG. 1

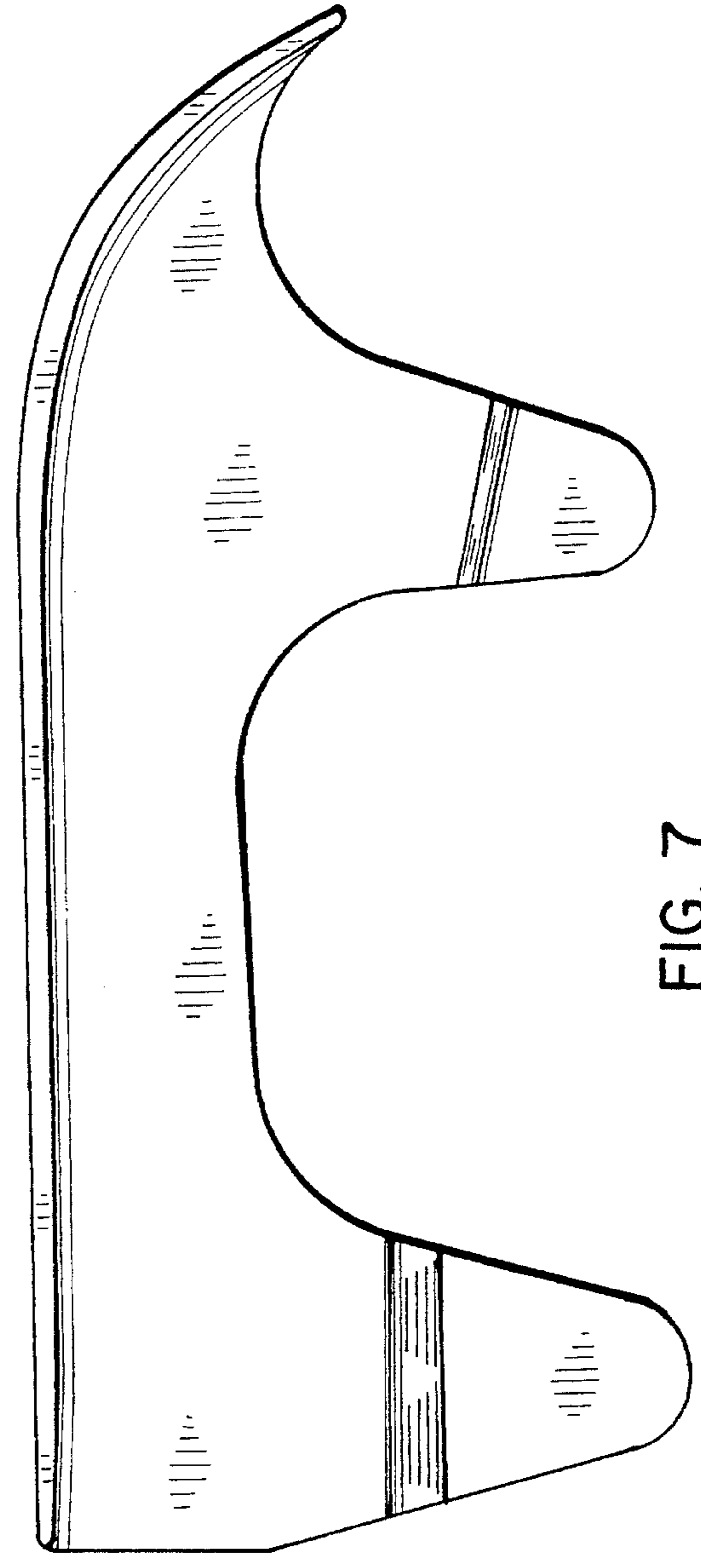

FIG. 7

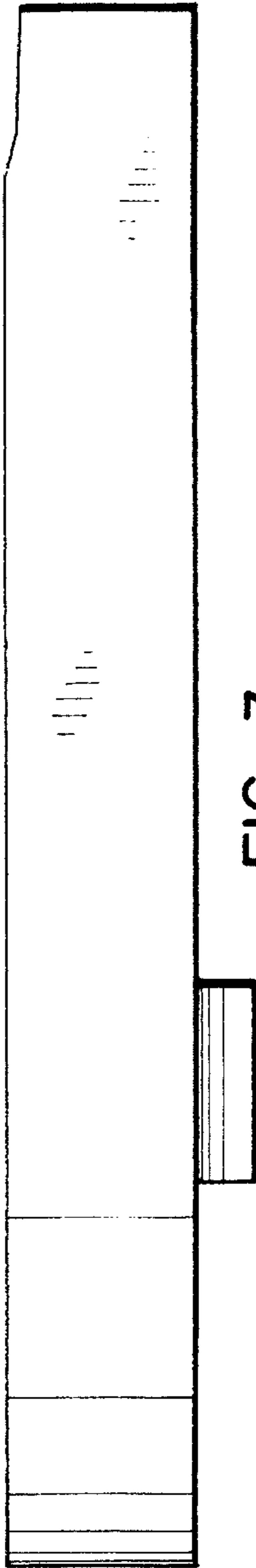

FIG. 3

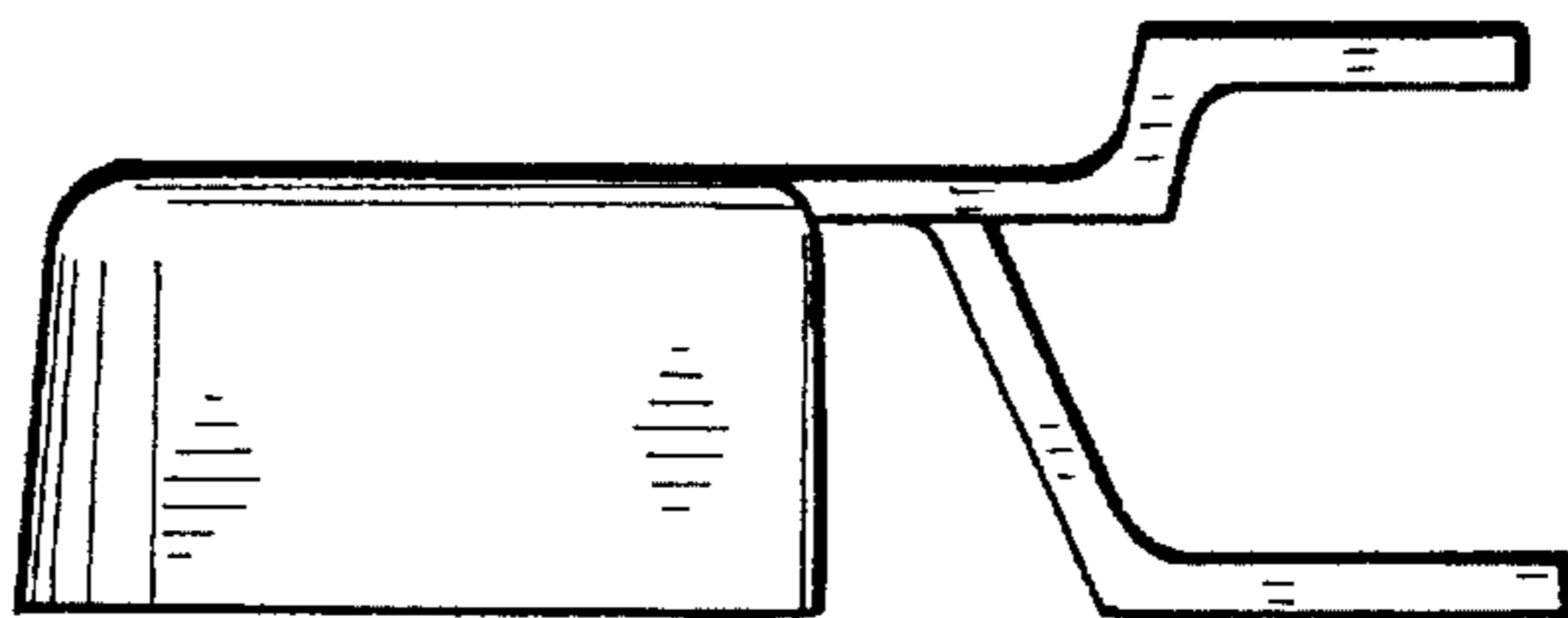

FIG. 2

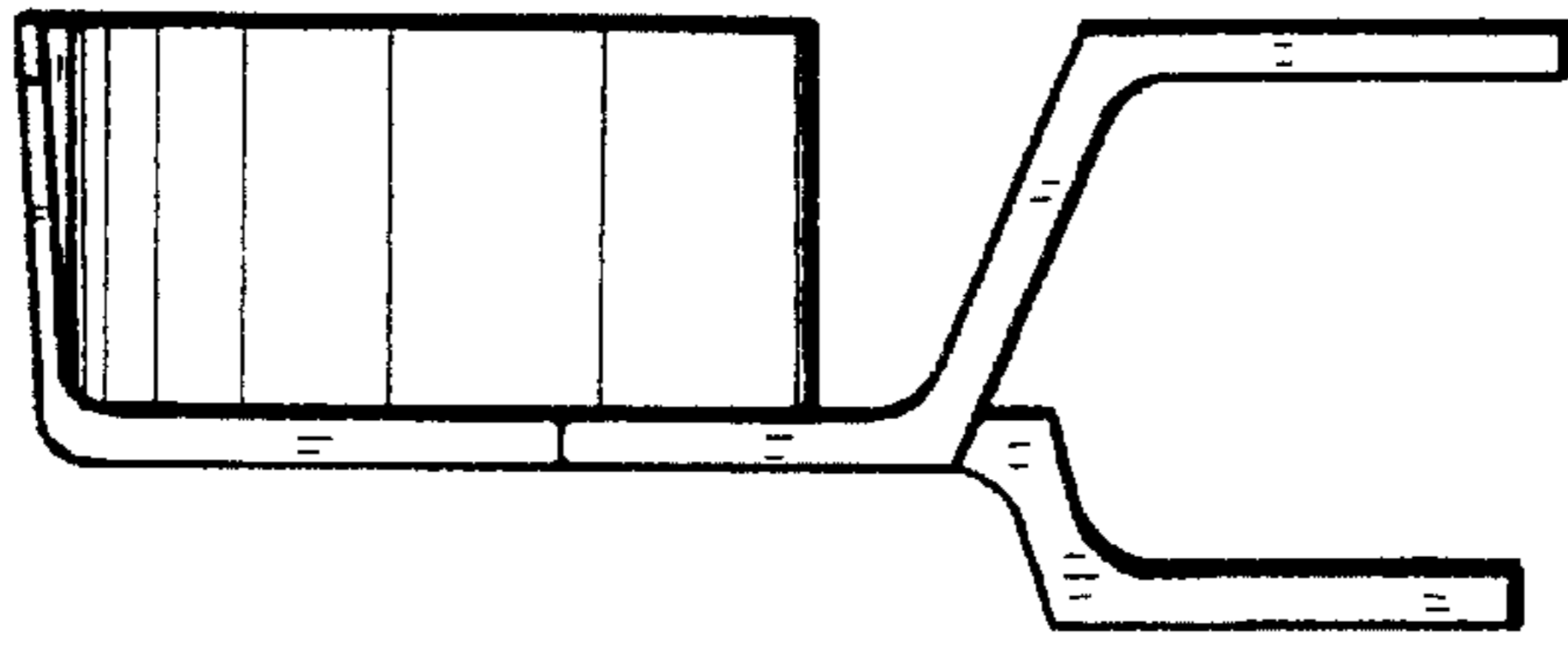

FIG. 4

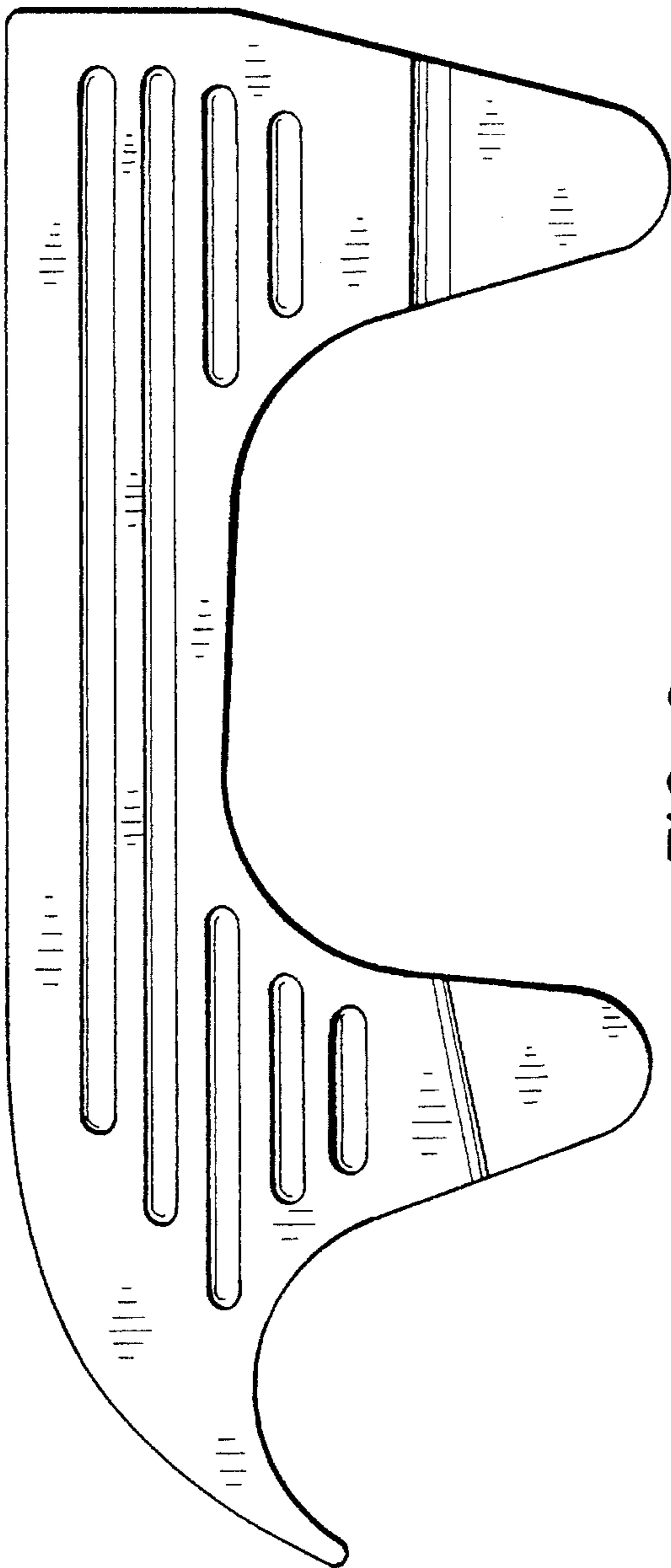

FIG. 6

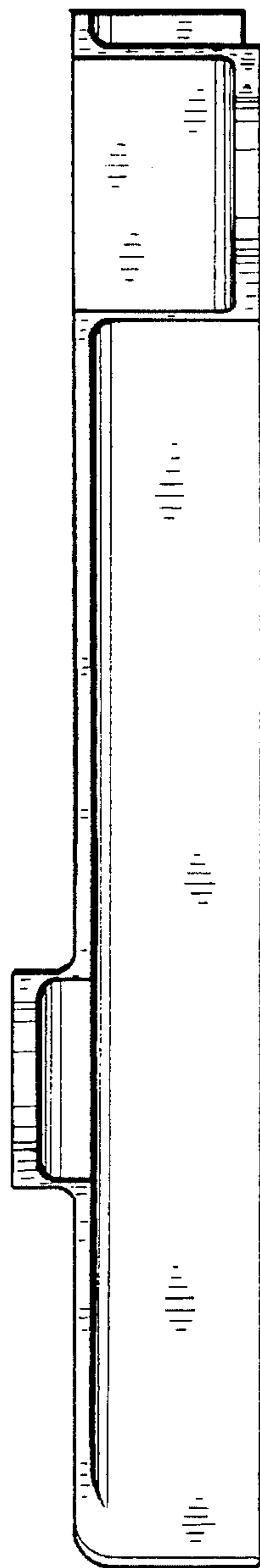

FIG. 5

UNITED STATES PATENT AND TRADEMARK OFFICE
CERTIFICATE OF CORRECTION

PATENT NO. : Des. 367,250
DATED : February 29, 1996
INVENTOR(S) : Kartchner

Page 1 of 4

It is certified that error appears in the above-identified patent and that said Letters Patent is hereby corrected as shown below:

On the title page, showing the illustrative figure, should be deleted to appear as per the attached title page.

The Drawing Sheets consisting of Figs. 1-7, should be deleted to be replaced with the Drawing Sheets, consisting of Fig. 1-7, as shown on the attached pages.

Signed and Sealed this
Seventeenth Day of September, 1996



Attest:

BRUCE LEHMAN

Attesting Officer

Commissioner of Patents and Trademarks

United States Patent [19]
Kartchner

[11] **Patent Number:** **Des. 367,250**
 [45] **Date of Patent:** ****Feb. 20, 1996**

[54] **CHAIN GUARD**

[76] **Inventor:** **Niles R. Kartchner**, 2622 SW. Temple,
 Salt Lake City, Utah 84115

[**] **Term:** **14 Years**

[21] **Appl. No.:** **35,270**

[22] **Filed:** **Feb. 23, 1995**

[52] **U.S. Cl.** **D12/127**

[58] **Field of Search** **D12/127; 74/558.5,**
 74/608, 611; 174/146, 147; 301/37 P, 37 SS;
 280/304.3

[56] **References Cited**

U.S. PATENT DOCUMENTS

D. 107,442	12/1937	Morgan	D12/127
D. 214,979	8/1969	Schreckengost	D12/127
D. 248,034	5/1978	Williams et al.	D12/127
D. 251,188	2/1979	Patterson et al.	D12/127
D. 355,872	2/1995	Haney et al.	D12/127

2,492,879	12/1949	Mueller	D12/127
4,908,008	3/1990	Gorski	474/146

Primary Examiner—Melody N. Brown
Attorney, Agent, or Firm—Foster & Foster; Lynn G. Foster

[57] **CLAIM**

The ornamental design for a chain guard, as shown.

DESCRIPTION

FIG. 1 is a perspective of a chain guard embodying my new design;

FIG. 2 is a front elevational view thereof;

FIG. 3 is a top plan view thereof;

FIG. 4 is a rear elevational view thereof;

FIG. 5 is a bottom plan view thereof;

FIG. 6 is a side elevational view as seen from the right side; and

FIG. 7 is a side elevation view as seen from the left side.

1 Claim, 2 Drawing Sheets

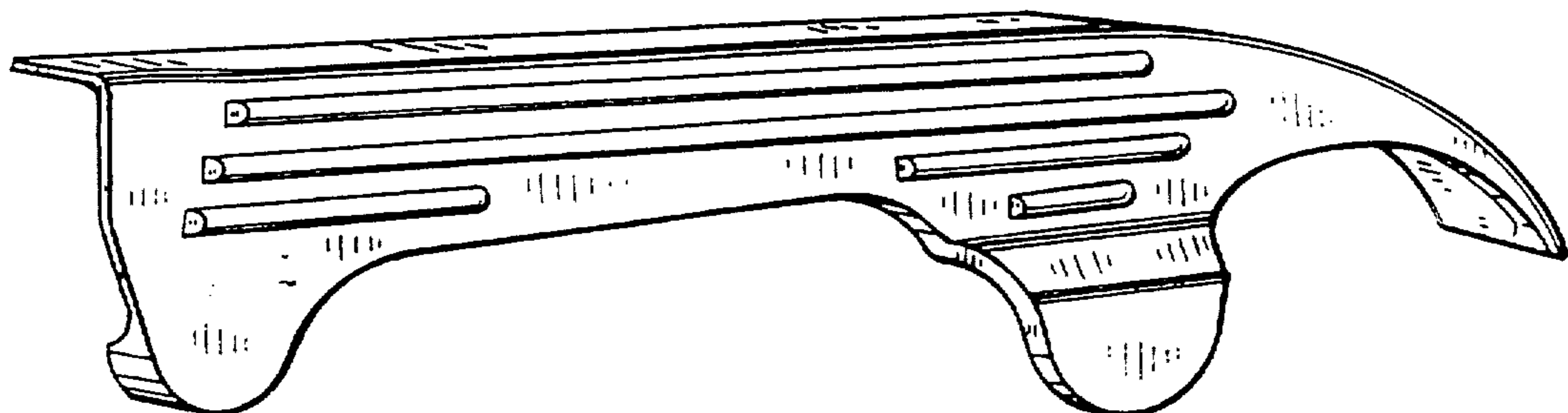

FIG. 1

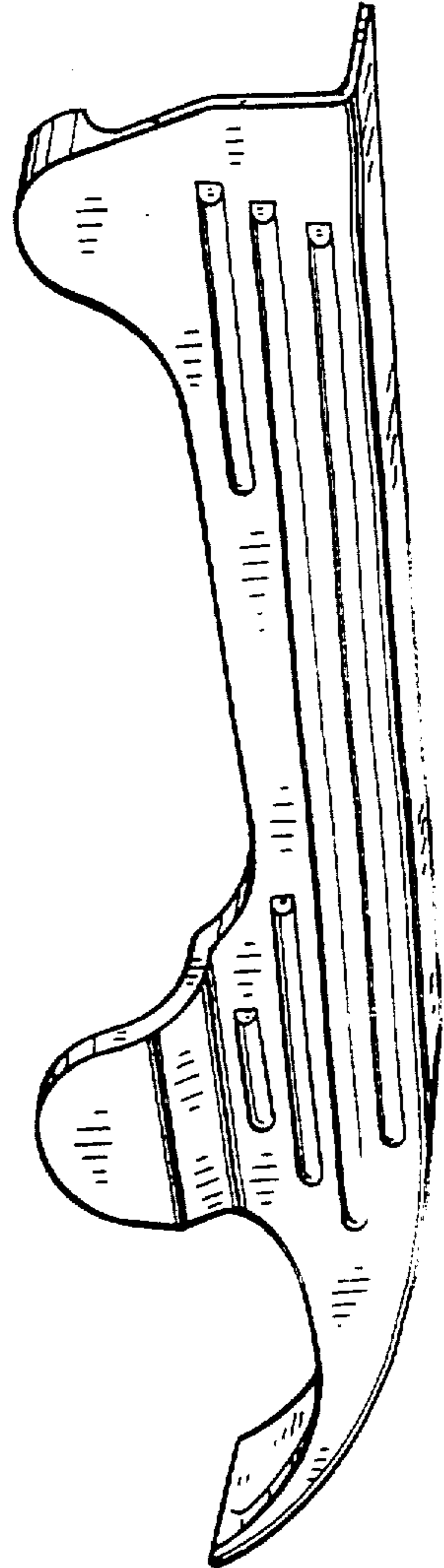

FIG. 1

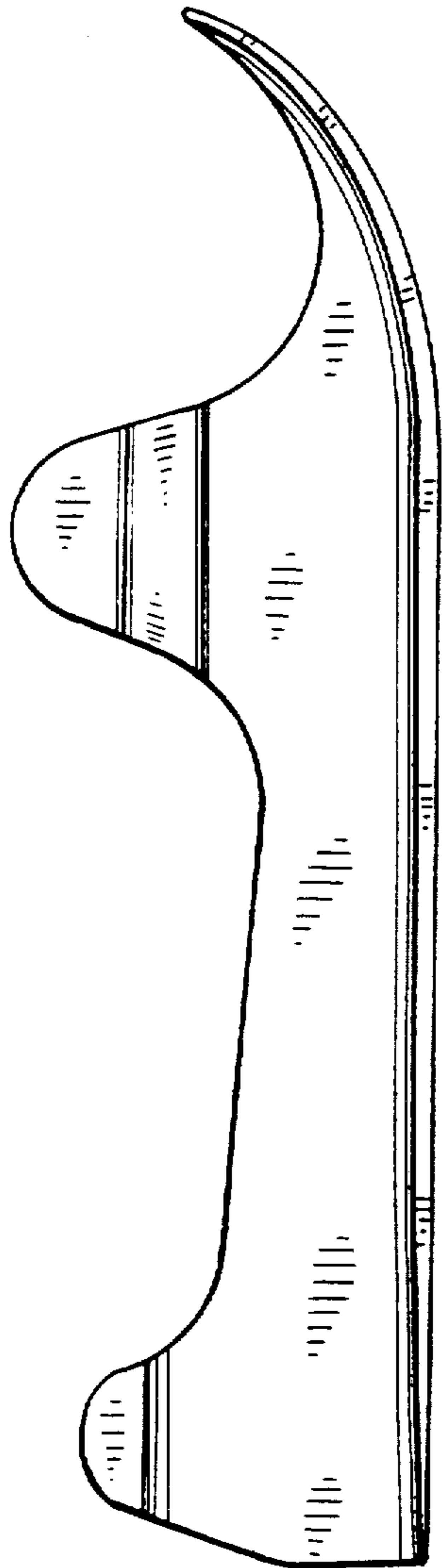

FIG. 7

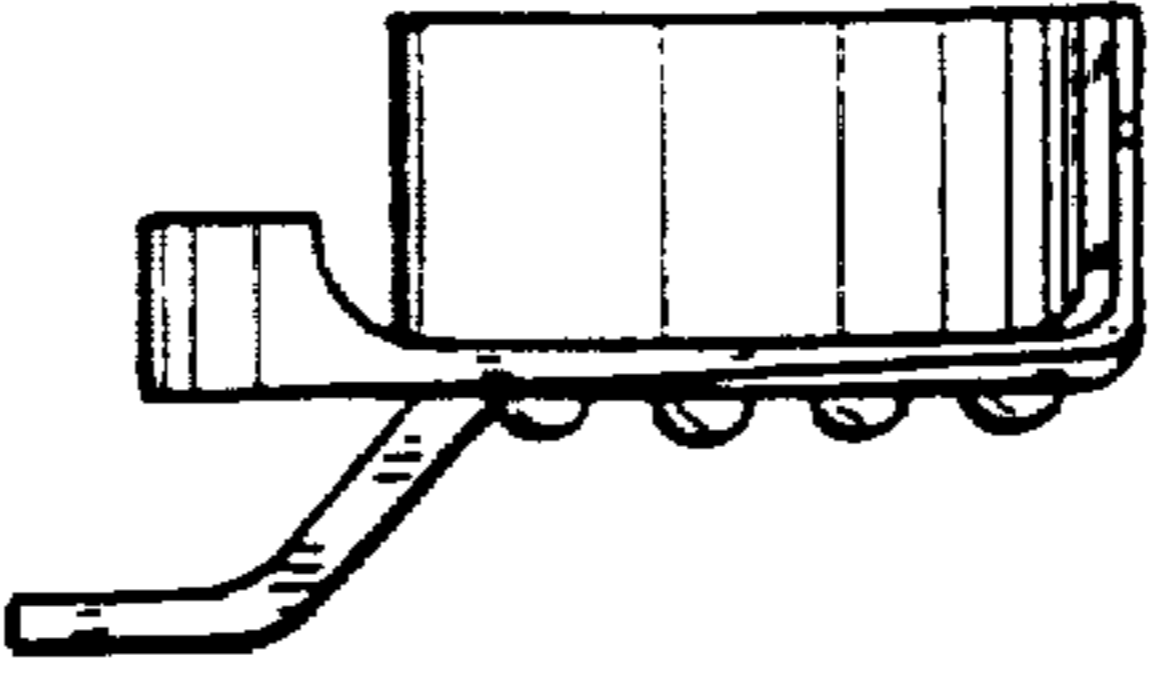

FIG. 4

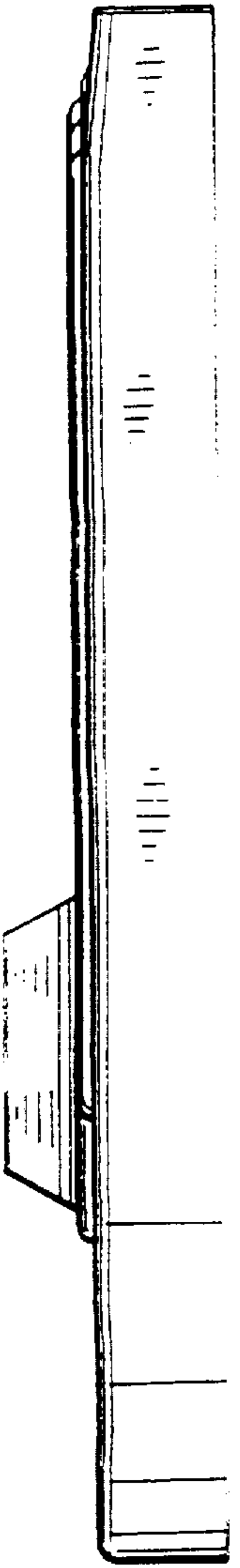

FIG. 3

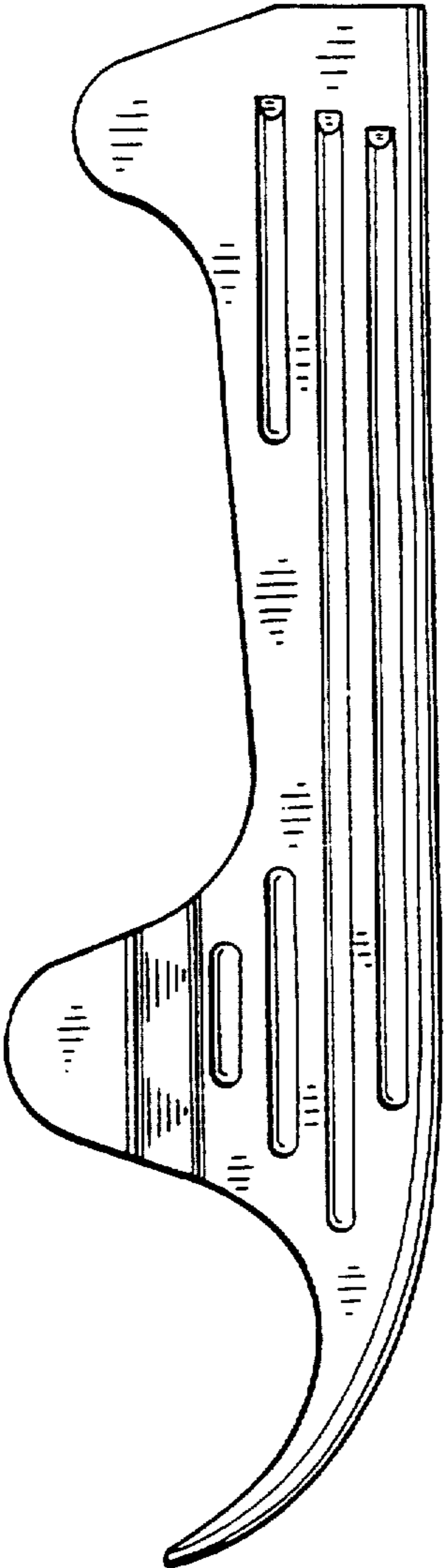

FIG. 6

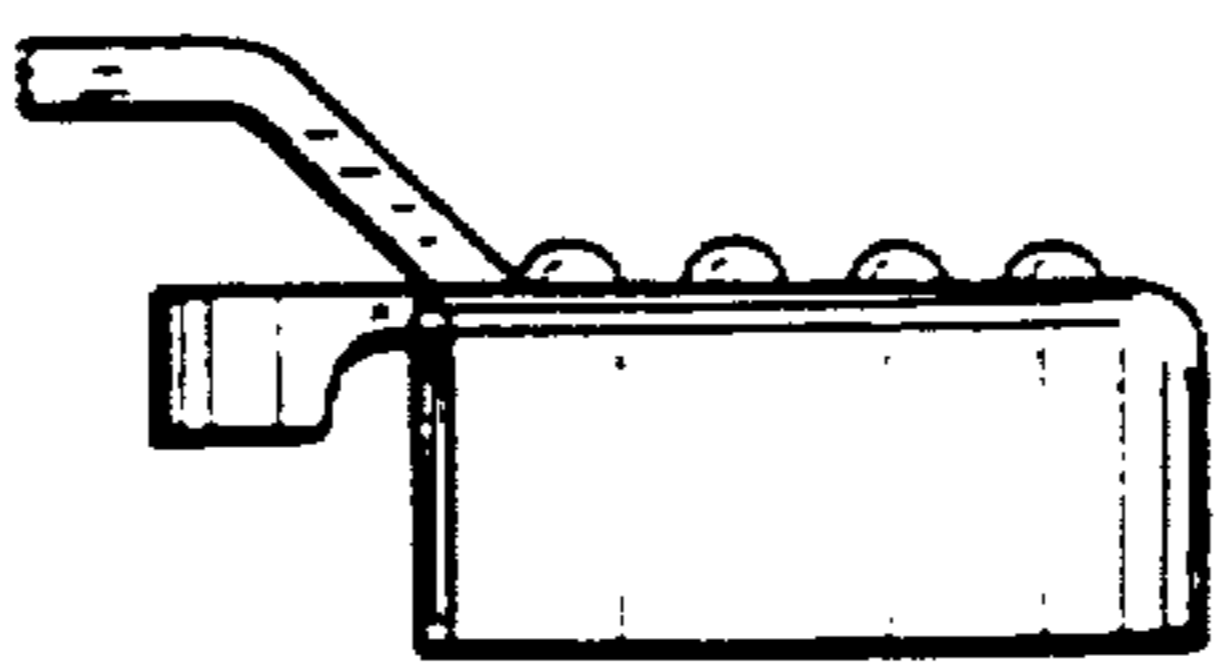

FIG. 2

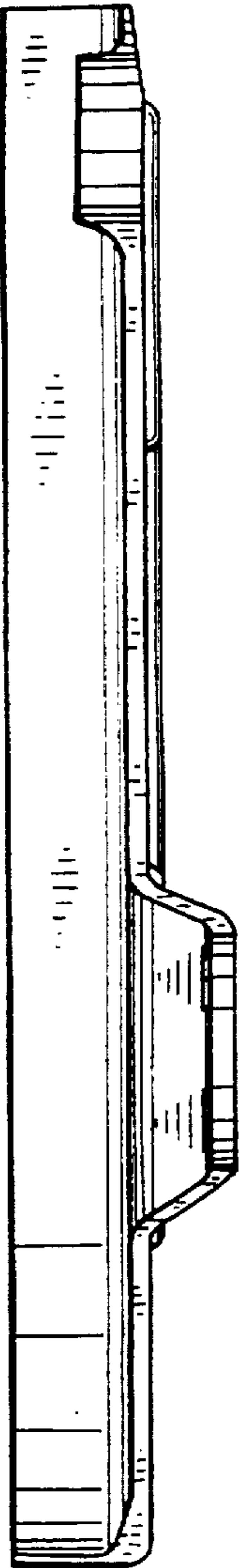

FIG. 5