



US00D367194S

United States Patent [19] Hannum

[11] Patent Number: Des. 367,194

[45] Date of Patent: **Feb. 20, 1996

[54] SUPPORT FOR FURNITURE

[75] Inventor: Richard C. Hannum, Ross, Calif.

[73] Assignee: The McGuire Furniture Company,
San Francisco, Calif.

[**] Term: 14 Years

[21] Appl. No.: 35,846

[22] Filed: Mar. 7, 1995

[52] U.S. Cl. D6/495

[58] Field of Search D6/480-495, 497,
D6/499, 495, 451; 108/151, 153, 156, 157,
161; 248/188, 188.1

[56] References Cited

U.S. PATENT DOCUMENTS

D. 216,715 3/1970 Dottinger D6/495
D. 339,002 9/1993 Wong D6/349

OTHER PUBLICATIONS

Superior Reed and Rattan, 1973, p. 23, table at top center #60.

Progressive, c1993, table legs.

Brown Jordan, p. 13, #1545-3636 table at top.

Calif-Asia Hermosa Rattan, c1974, p. 57, table in center.

Page from McGuire catalog showing table supported by bamboo legs, 1992.

P. 49 from McGuire catalog showing table supported by bamboo legs, 1992.

Page from McGuire catalog showing table supported by bamboo legs, 1985.

Page from McGuire catalog showing ZA-83 table, 1985.

P. 25 from Baker catalog showing secretary-bookcase, 1991.

P. 13 from Baker catalog showing nightstand and chest-on-chest, 1990.

P. 8 from Baker catalog showing sideboards, 1990.

P. 117 from Baker catalog showing chest, 1988.

P. 14 from Baker catalog showing server, 1994.

Primary Examiner—Janice E. Seeger

Attorney, Agent, or Firm—Quarles & Brady

[57] CLAIM

The ornamental design for a support for furniture, as shown and described.

DESCRIPTION

FIG. 1 is a perspective view taken from the top, front and left side of a support for furniture embodying my new design, in the form of a leg support for furniture such as a table, cabinet, or bookcase;

FIG. 2 is a front elevational view thereof, the rear elevational view being the mirror image thereof;

FIG. 3 is a right side elevational view thereof, the left side elevational view being the mirror image thereof;

FIG. 4 is a top plan view thereof;

FIG. 5 is a front and rear elevational view of a second embodiment having legs identical to the first, side views identical to the first, and with a top view similar to FIG. 4 but with the cross bar and central marking proportional to the front view;

FIG. 6 is a front elevational view of a third embodiment, the rear elevational view being the mirror image thereof;

FIG. 7 is a right side elevational view of the FIG. 6 embodiment, the left side elevational view being the mirror image thereof;

FIG. 8 is a top plan view of the FIG. 6 embodiment;

FIG. 9 is a front and rear elevational view of a fourth embodiment having legs identical to the third, side views identical to the third, and with a top view similar to FIG. 8 but with the cross bar and central marking proportional to the front view;

FIG. 10 is a front elevational view of a fifth embodiment, the rear elevational view being the mirror image thereof;

FIG. 11 is a front elevational view of a sixth embodiment, the rear elevational view being the mirror image thereof;

FIG. 12 is a right side elevational view of the FIG. 11 embodiment, the left side elevational view being the mirror image thereof;

FIG. 13 is a top plan view of the FIG. 11 embodiment;

FIG. 14 is a front and rear elevational view of a seventh embodiment having legs identical to the sixth, side views identical to the sixth, and with a top view similar to FIG. 13 but with the cross bar and central marking proportional to the front view;

(Description continued on next page.)

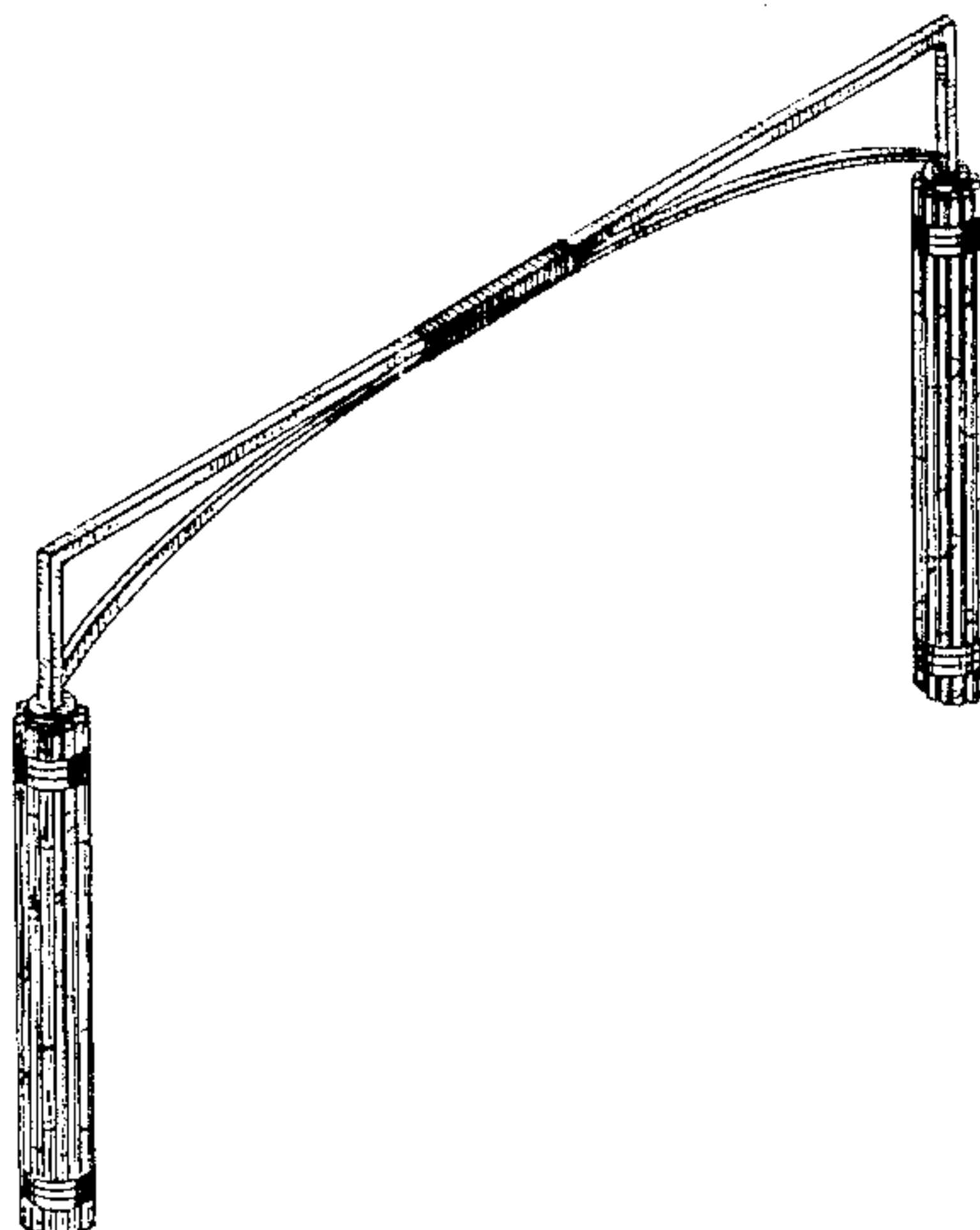

FIG. 15 is a front and rear elevational view of an eighth embodiment;

FIG. 16 is a right side elevational view of the FIG. 15 embodiment, the left side elevational view being the mirror image thereof;

FIG. 17 is a top plan view of the FIG. 15 embodiment;

FIG. 18 is a front and rear elevational view of a ninth embodiment;

FIG. 19 is a right side elevational view of the FIG. 18 embodiment, the left side elevational view being the mirror image thereof;

FIG. 20 is a top plan view of the FIG. 18 embodiment; and,

FIG. 21 is a front and rear elevational view of a tenth embodiment, having legs identical to the ninth, side views identical to the ninth, and with a top view similar to FIG. 20 but with the cross bar and central marking proportional to the front view.

The fragmentary broken line representations of additional linked support elements in FIGS. 3, 7, 12, 16 and 19 are for the purpose of illustration only and form no part of the claimed design.

1 Claim, 7 Drawing Sheets

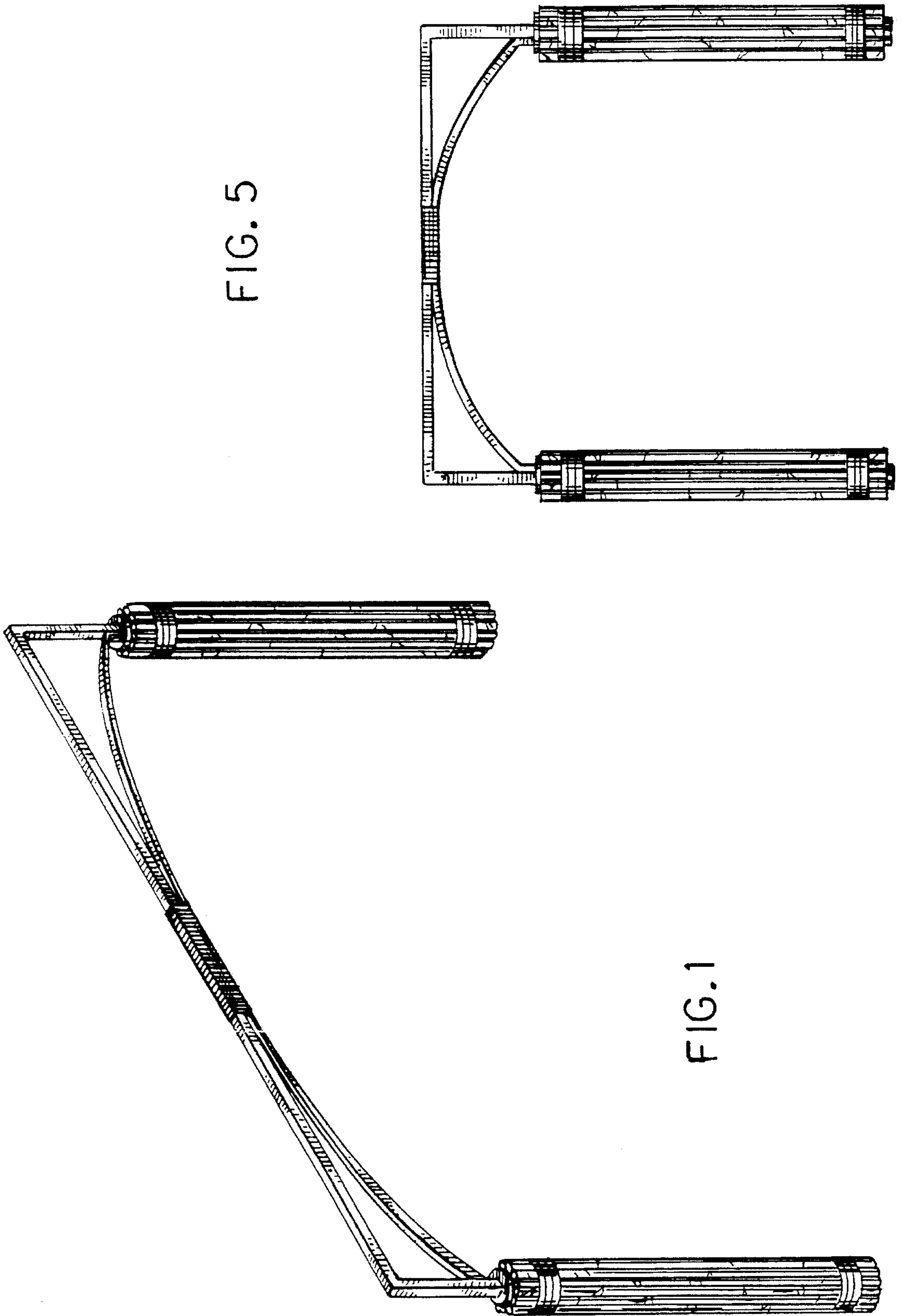

FIG. 5

FIG. 1

FIG. 4

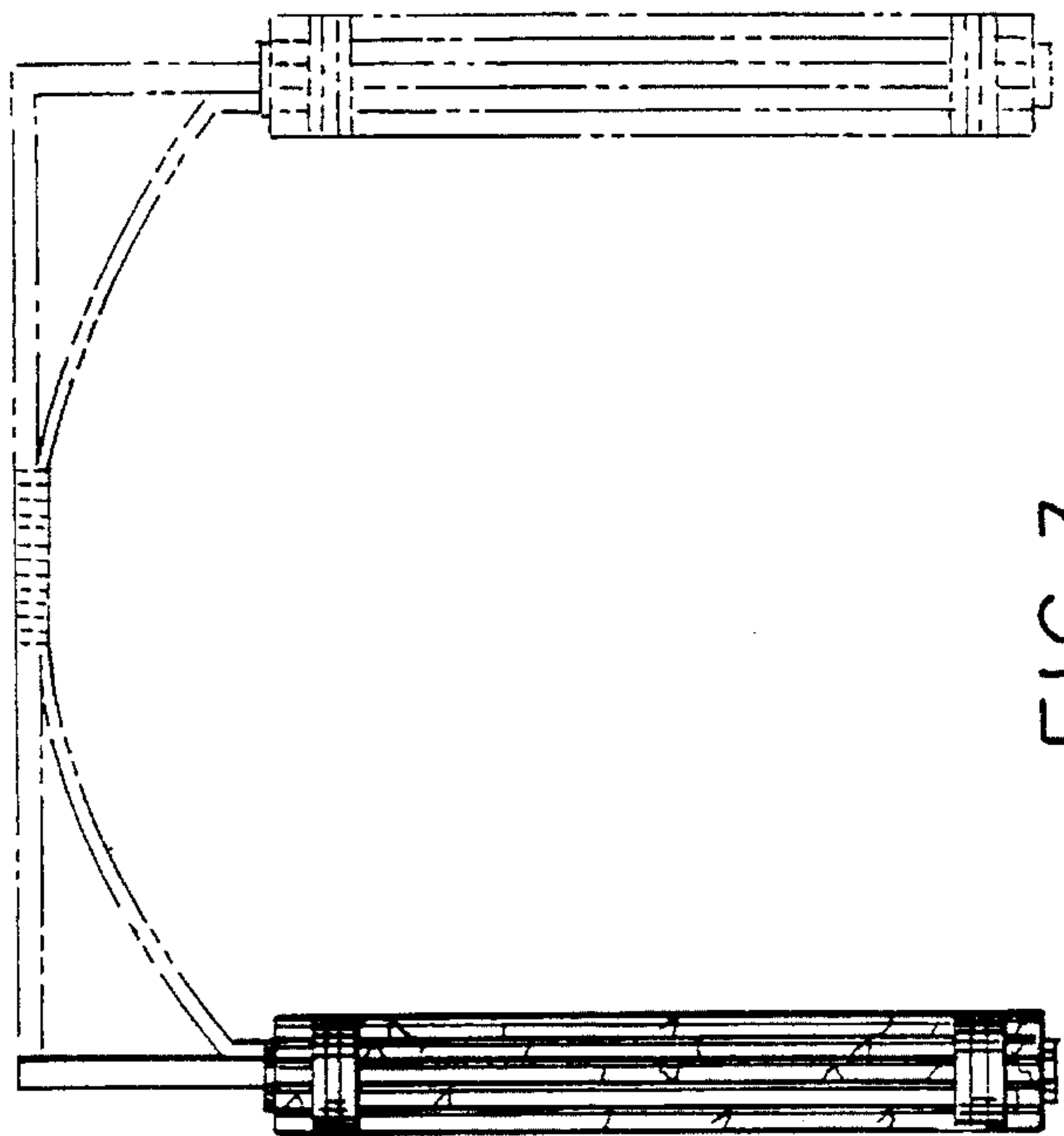
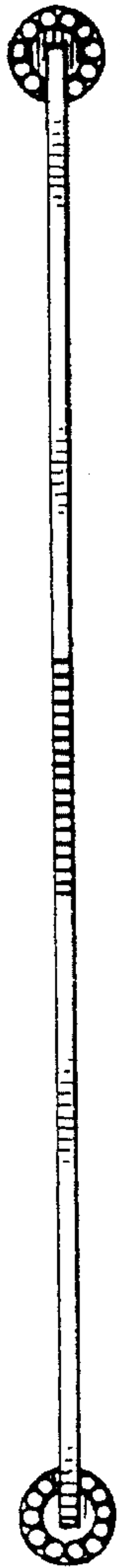

FIG. 3

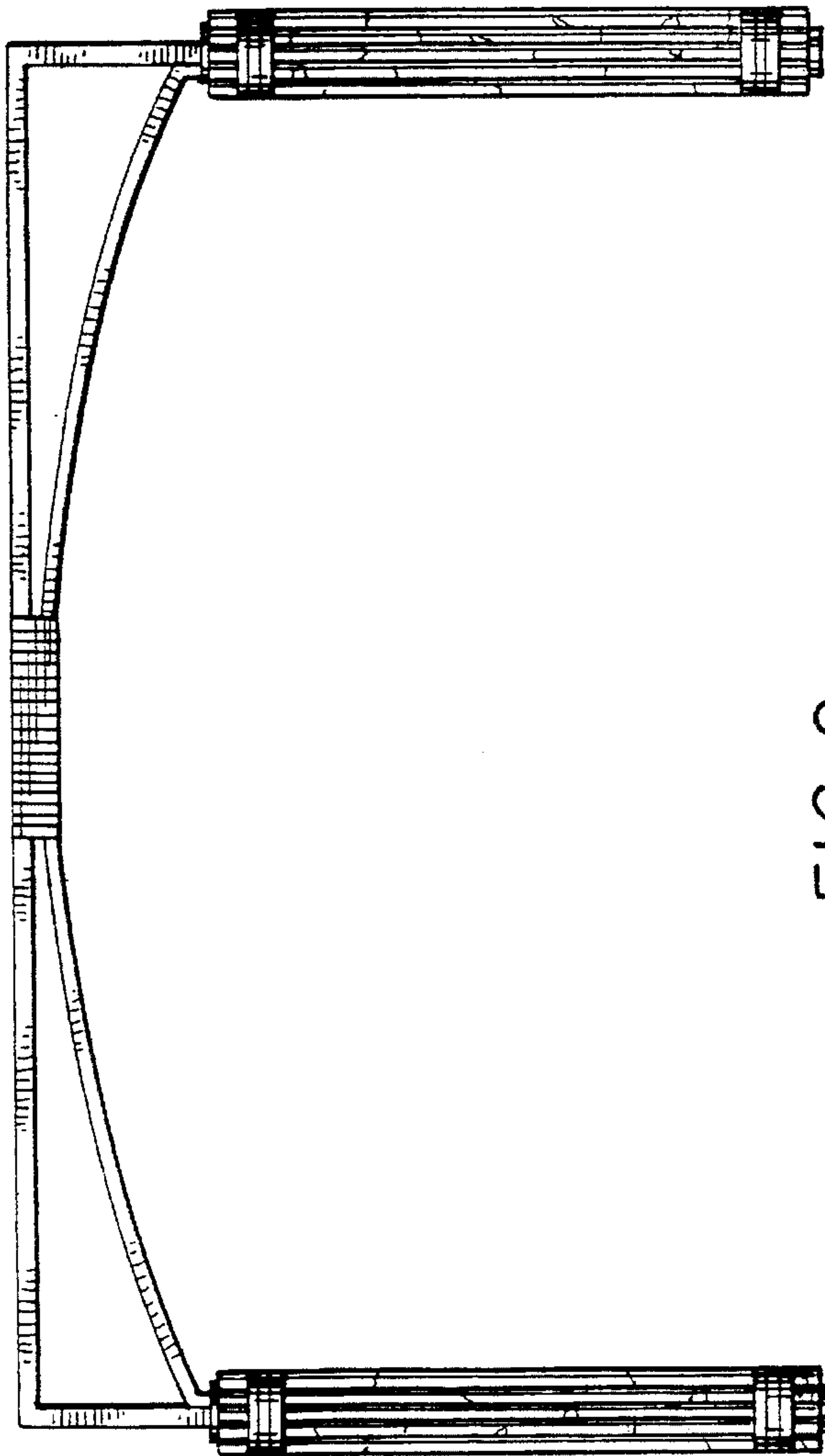

FIG. 2

FIG. 8

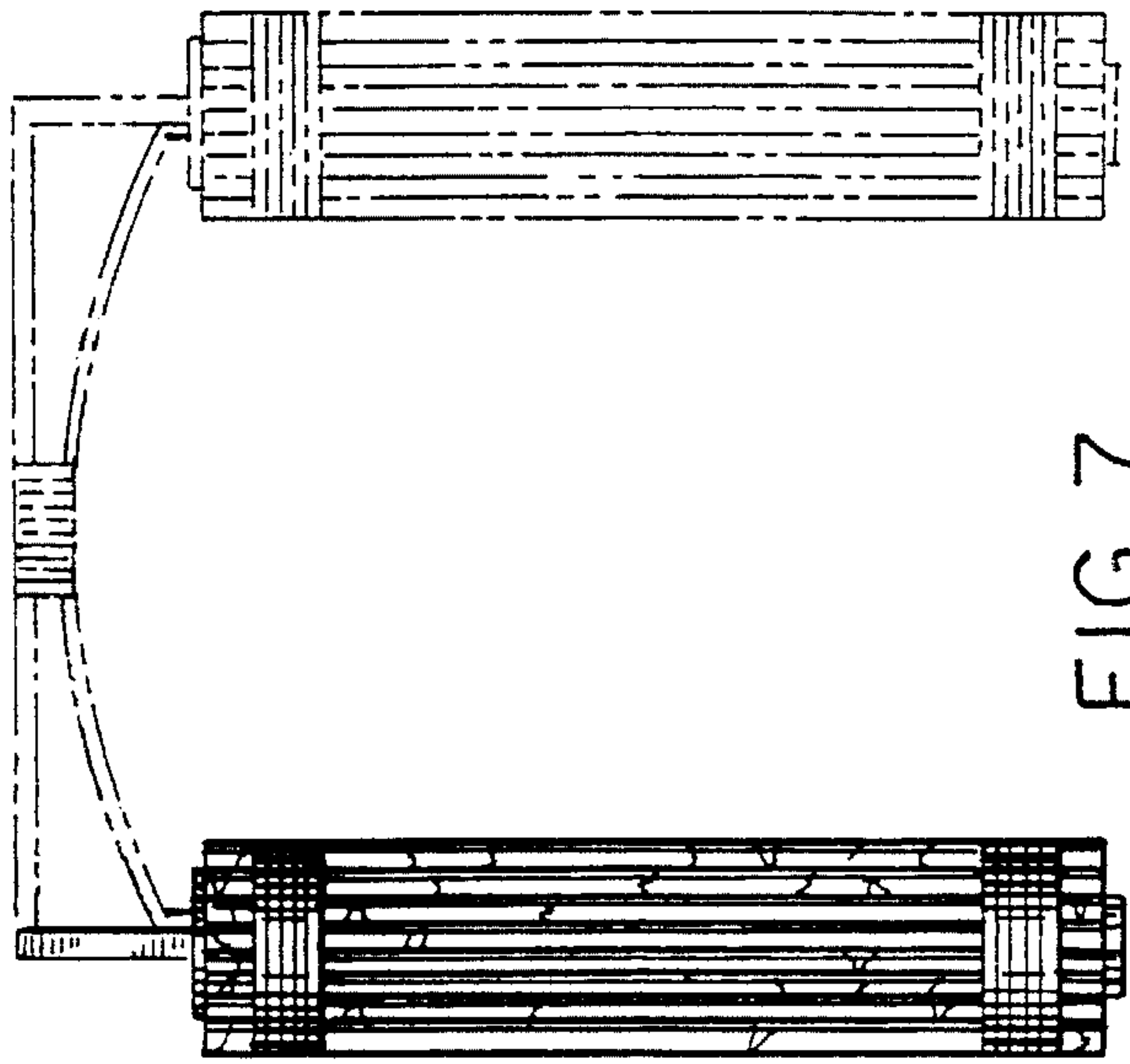
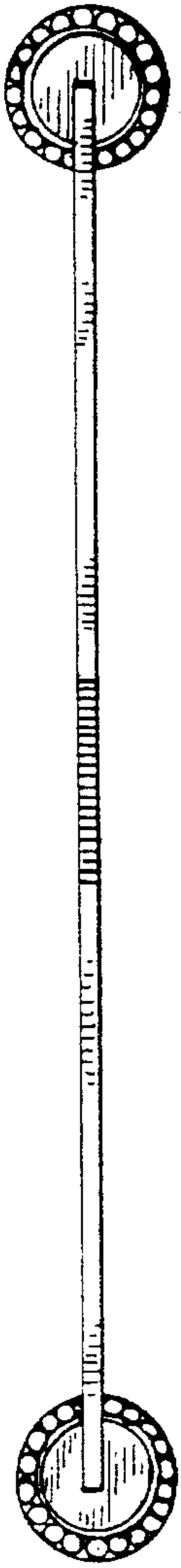

FIG. 7

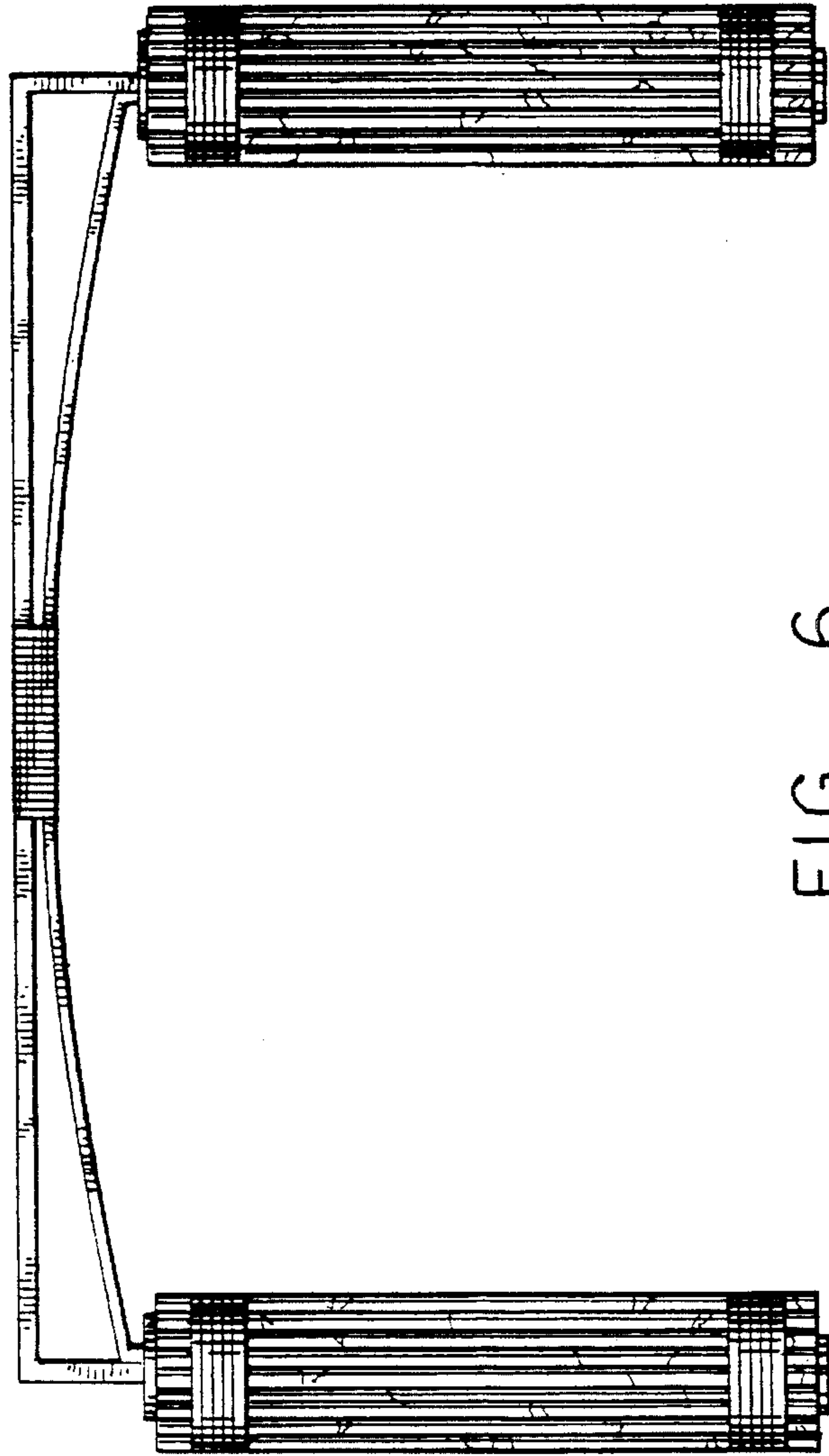

FIG. 6

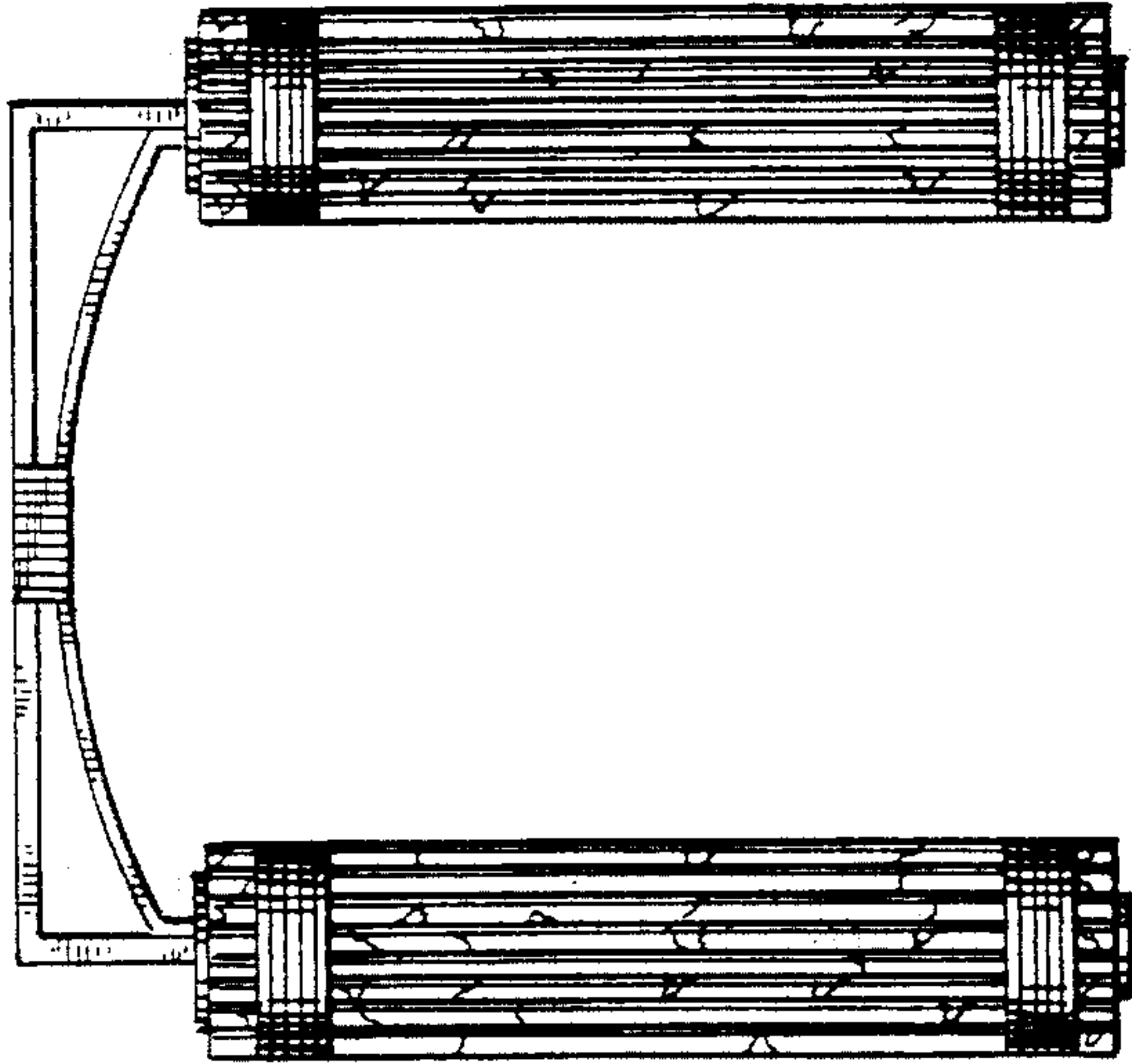

FIG. 9

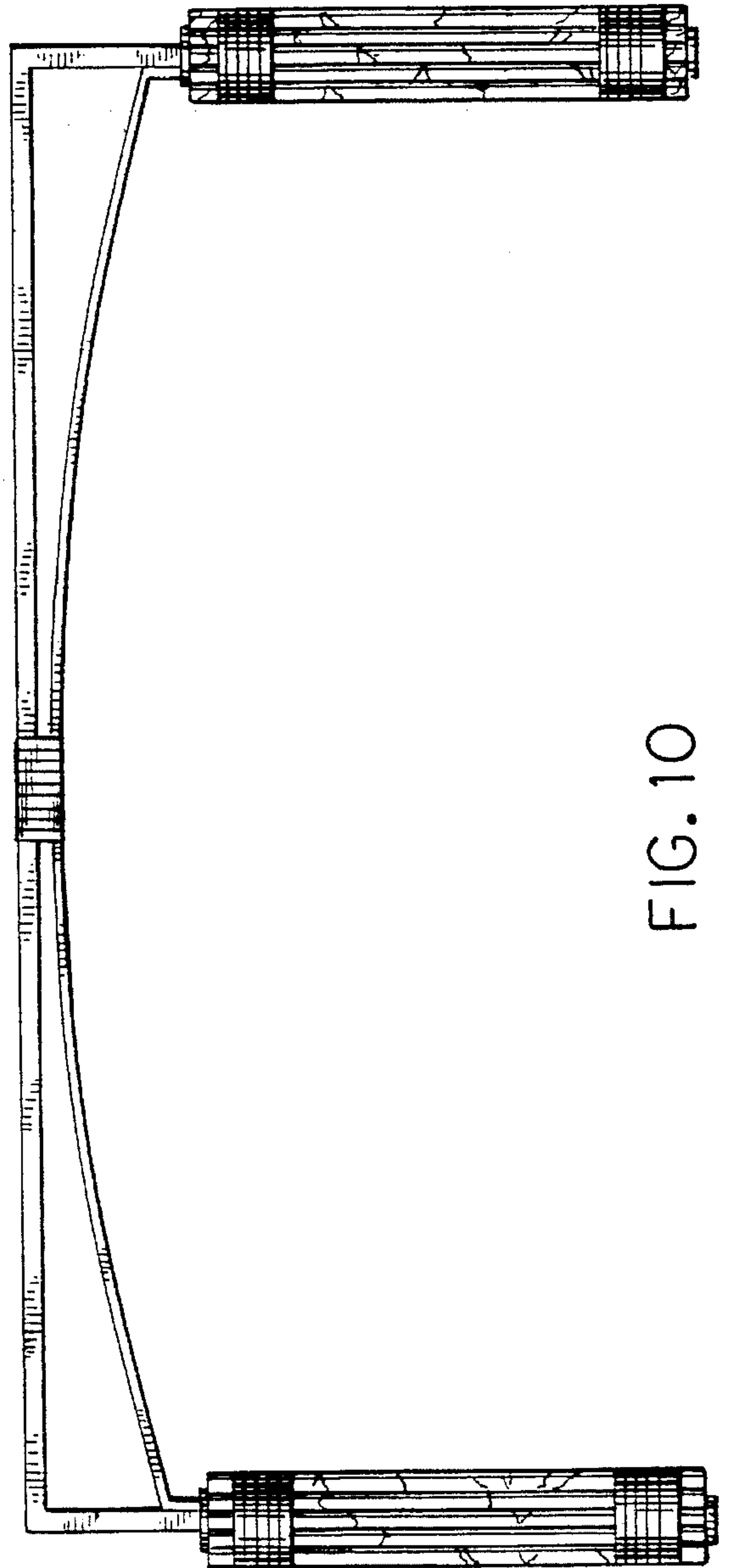

FIG. 10

FIG. 13

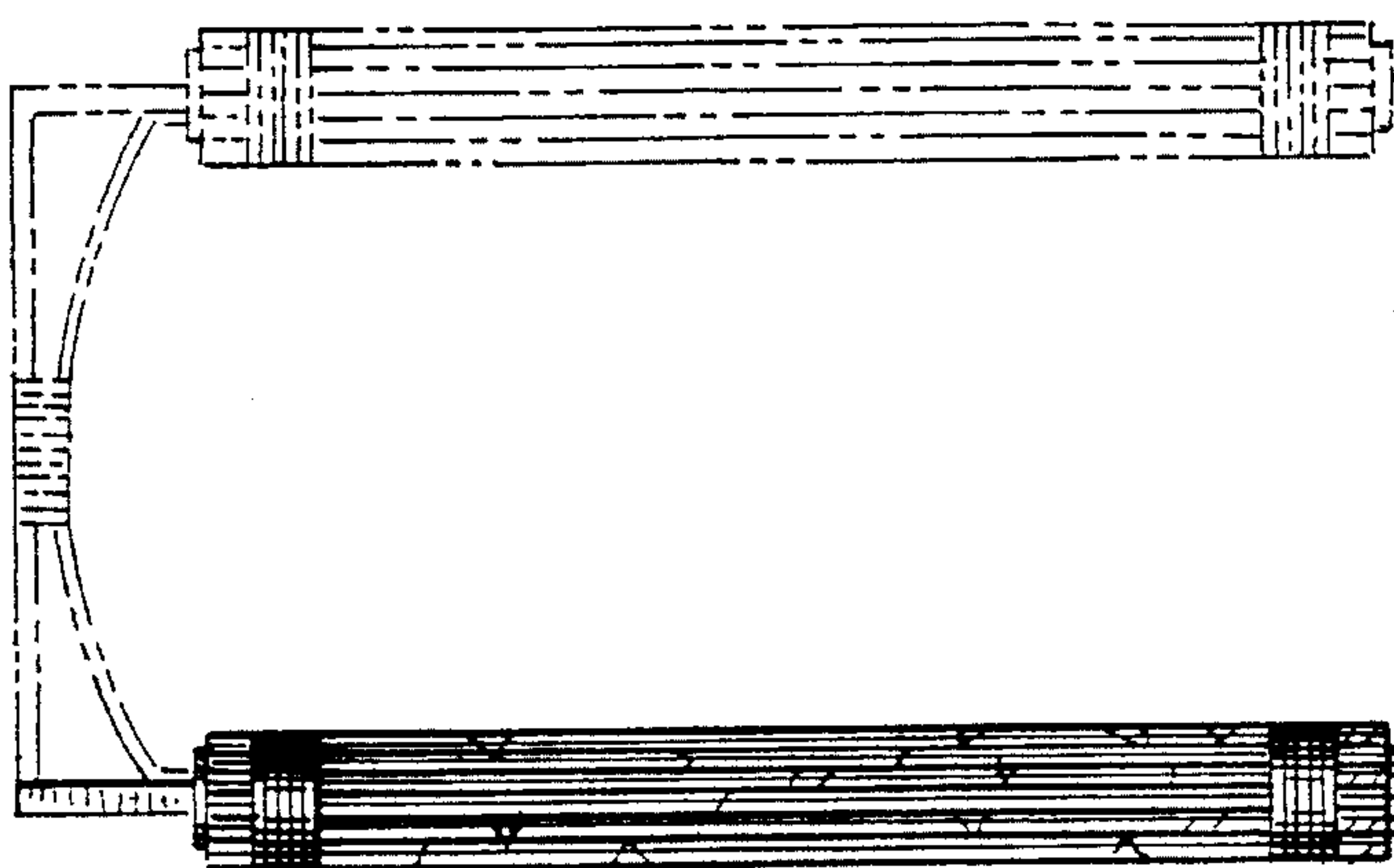
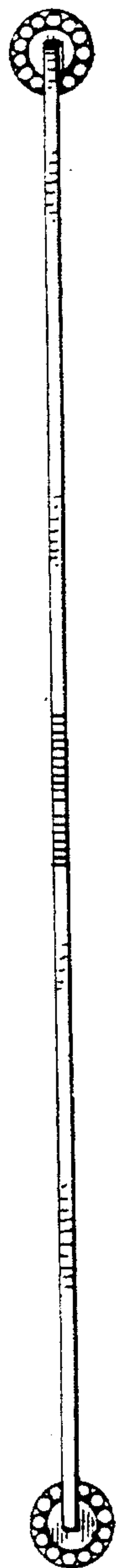

FIG. 12

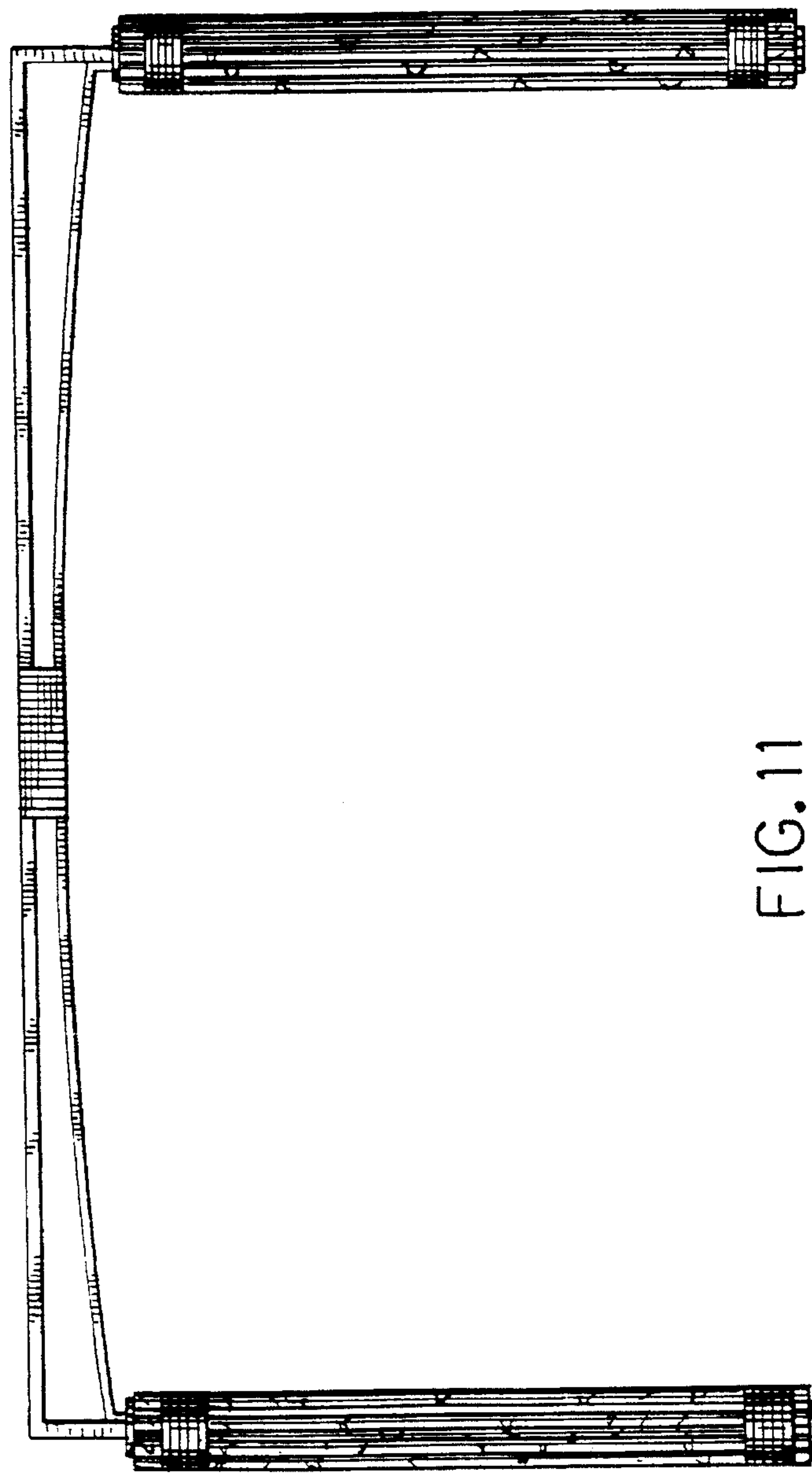

FIG. 11

FIG. 17

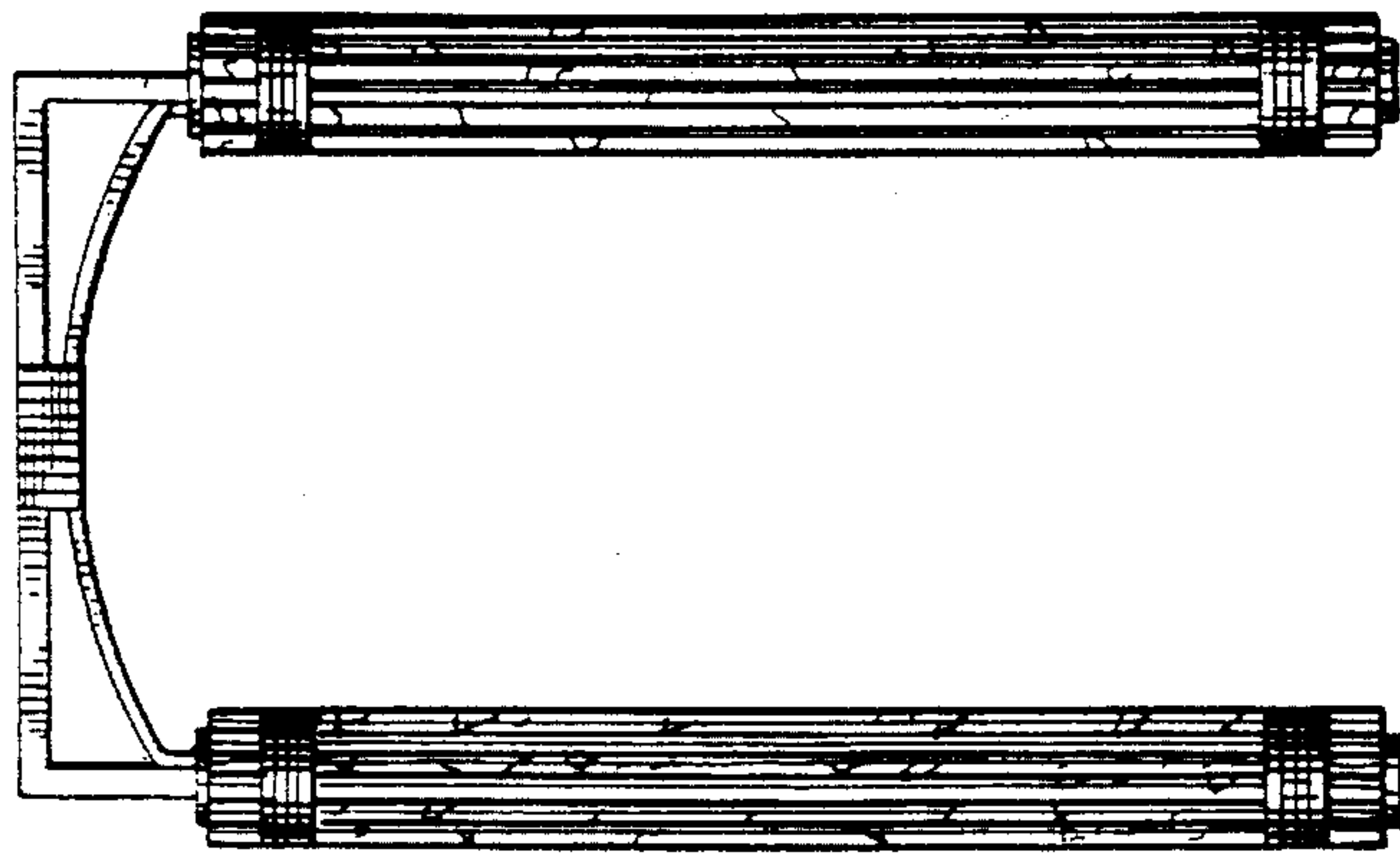
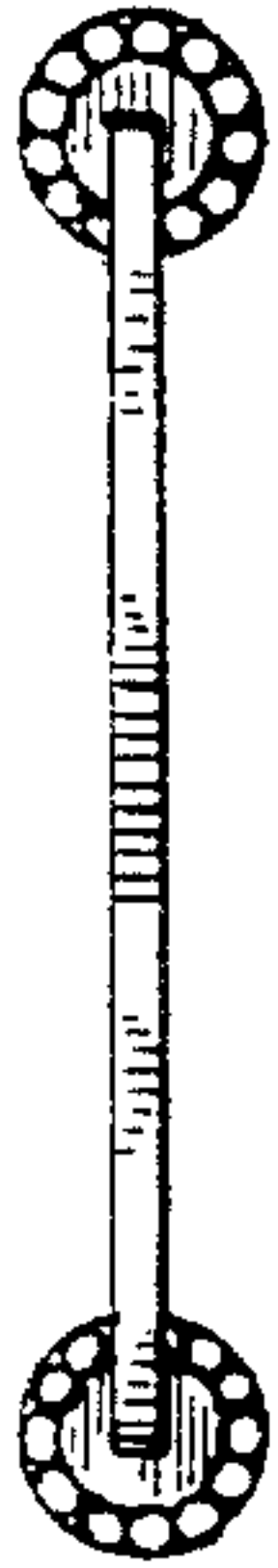

FIG. 14

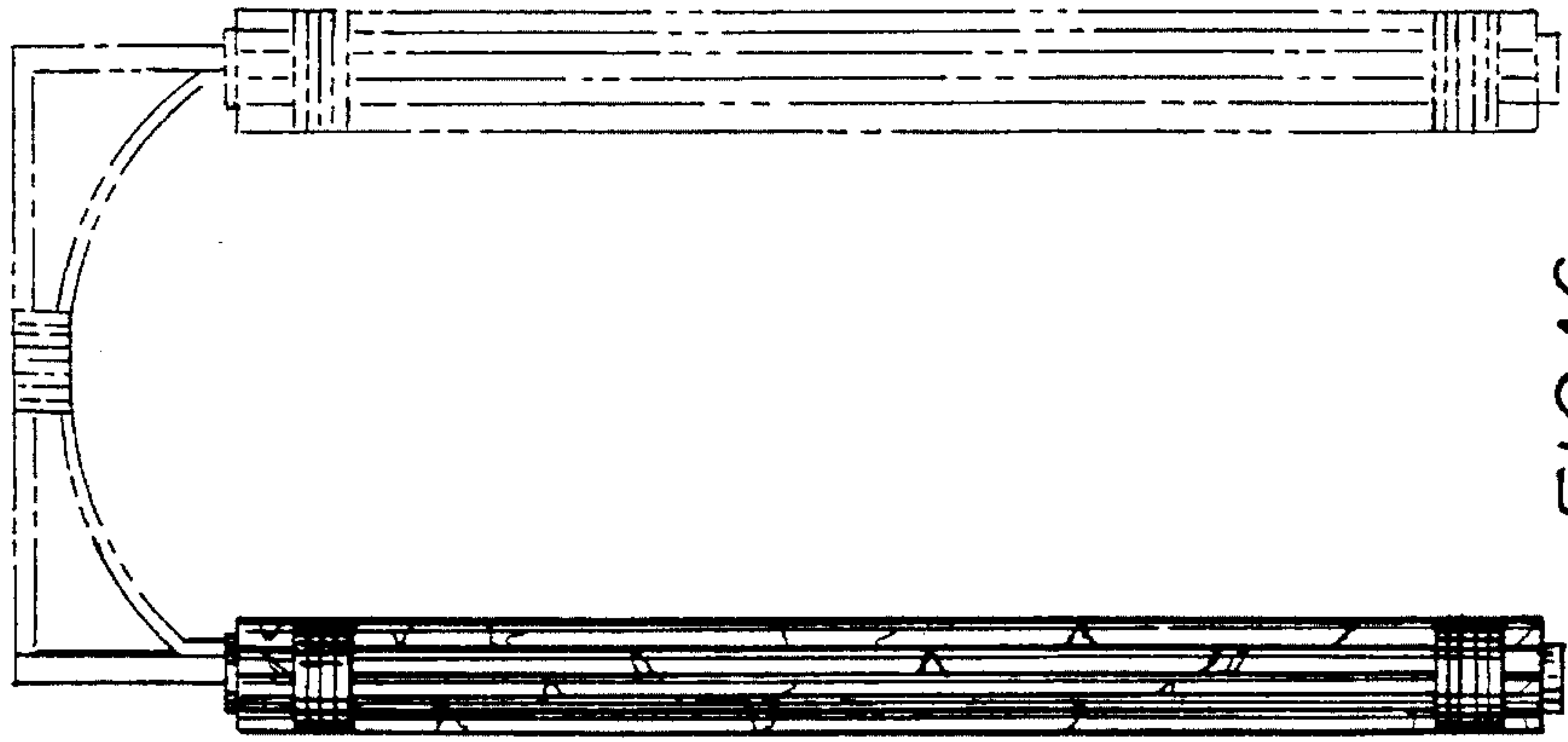

FIG. 16

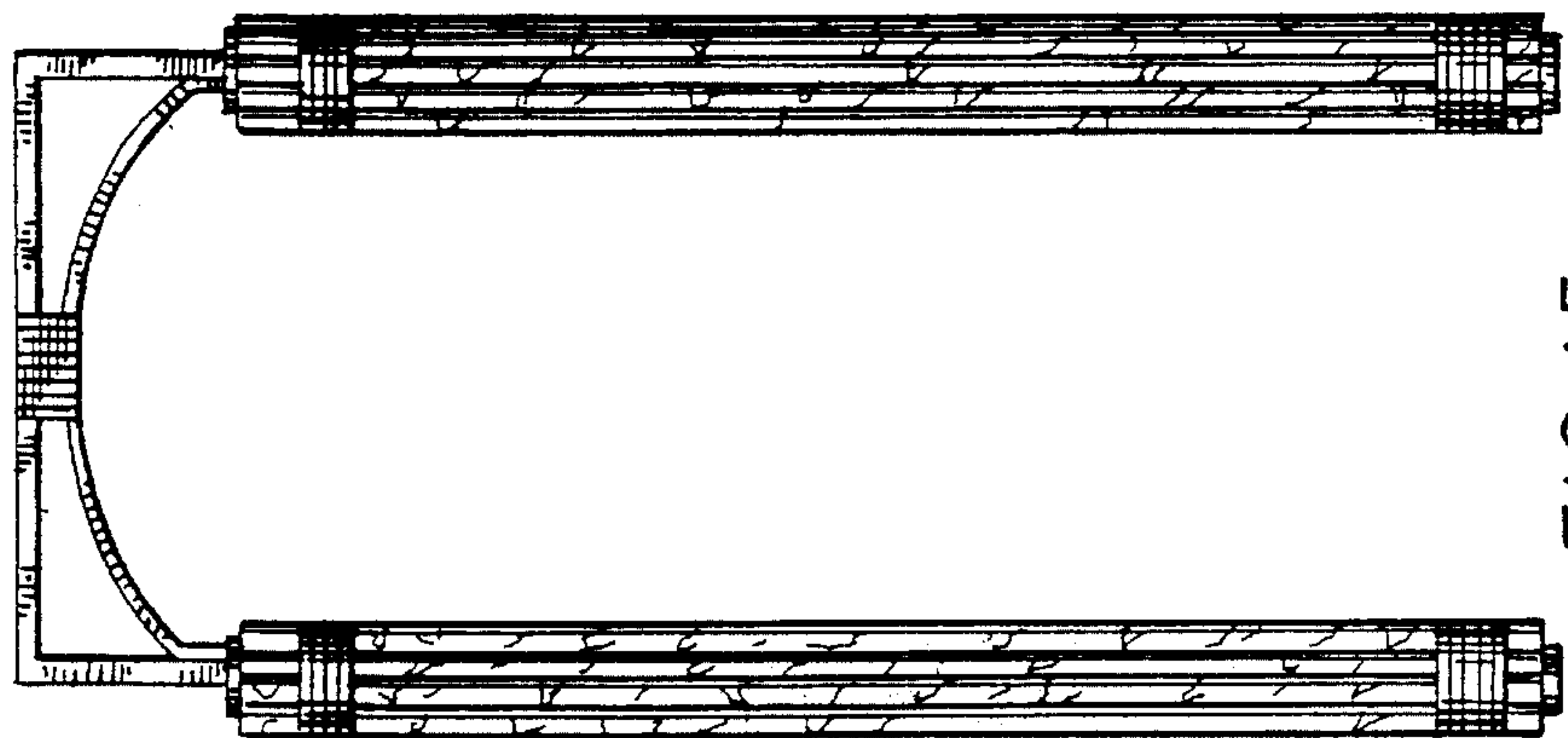

FIG. 15

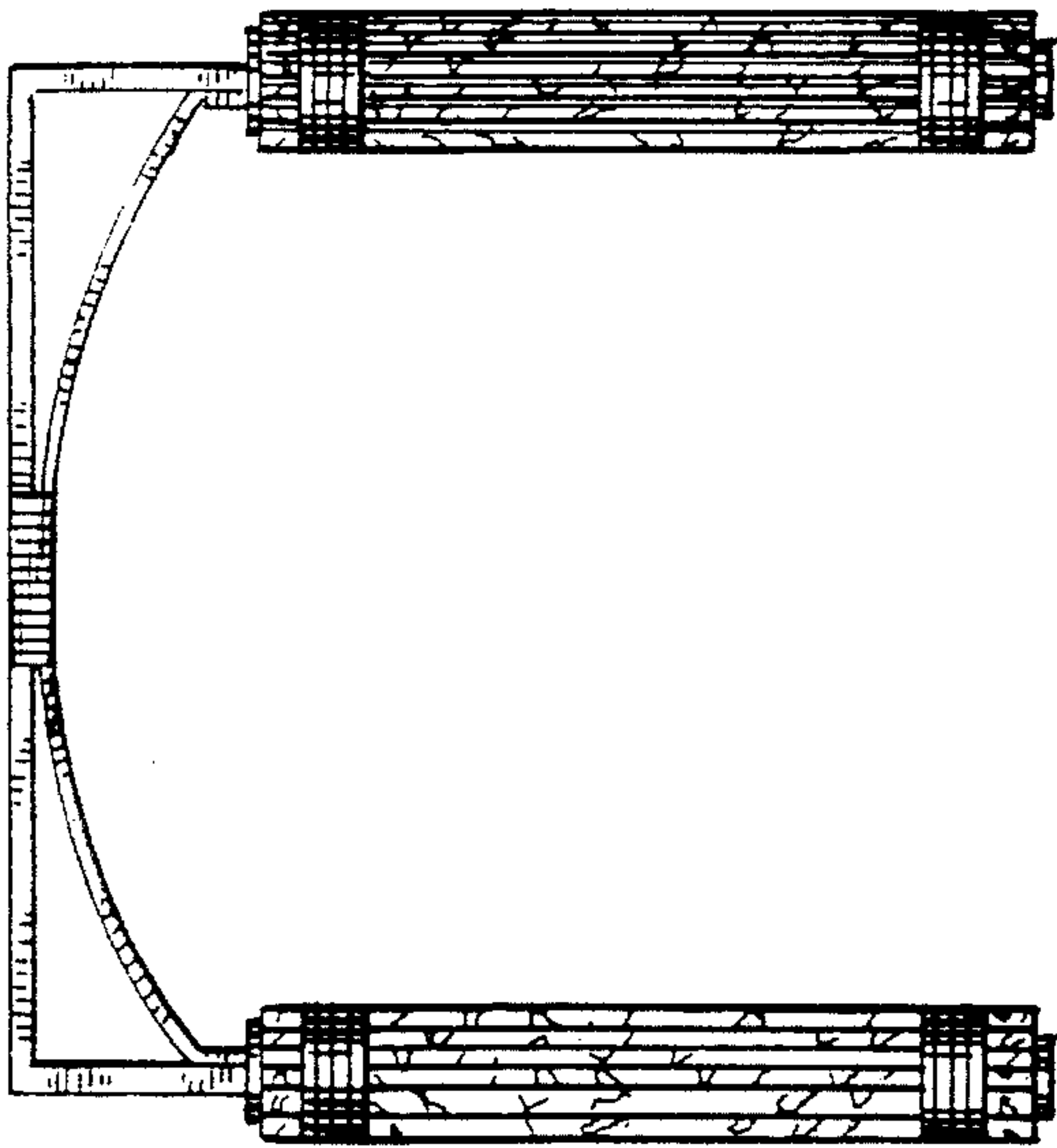

FIG. 21

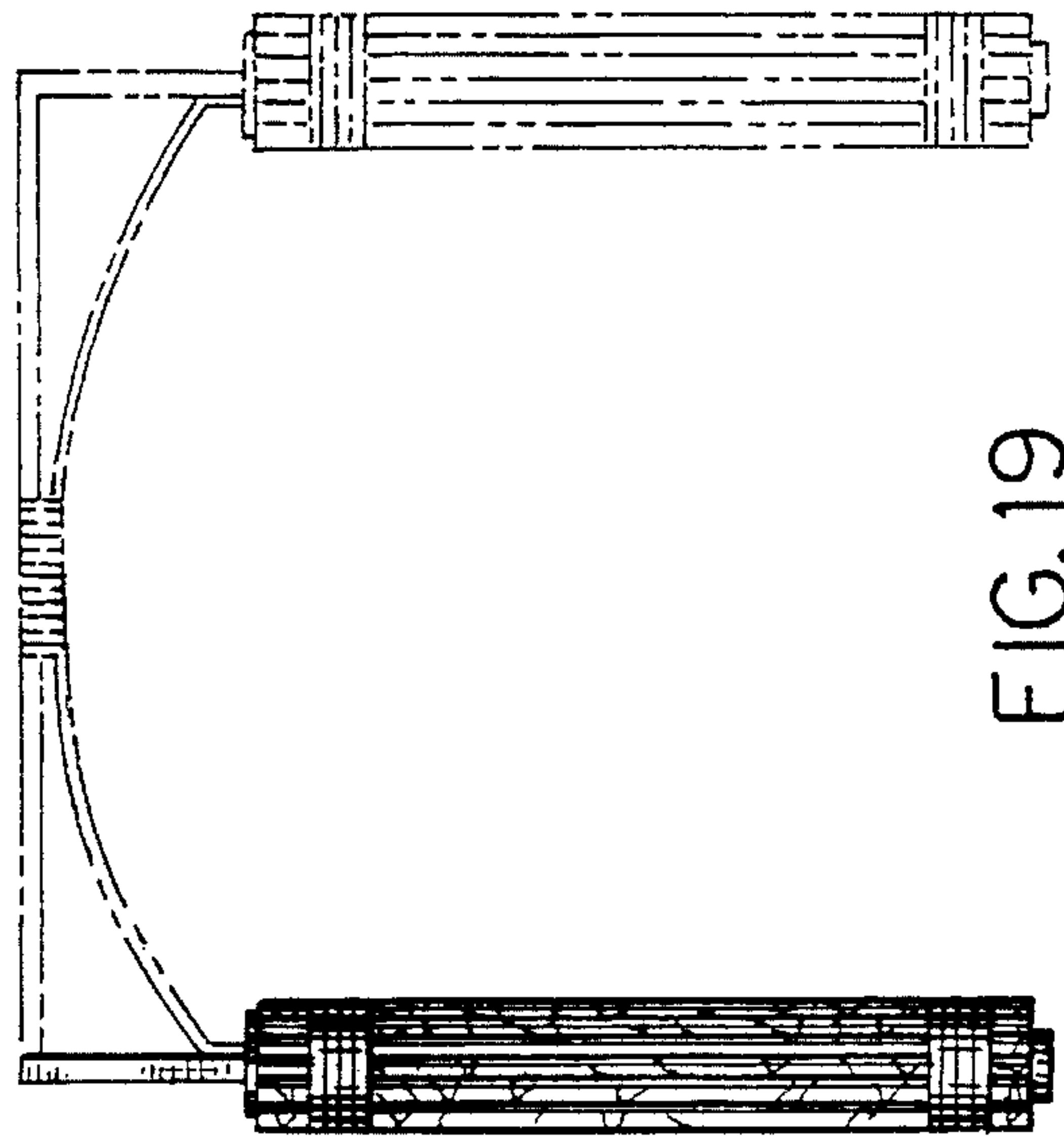

FIG. 19

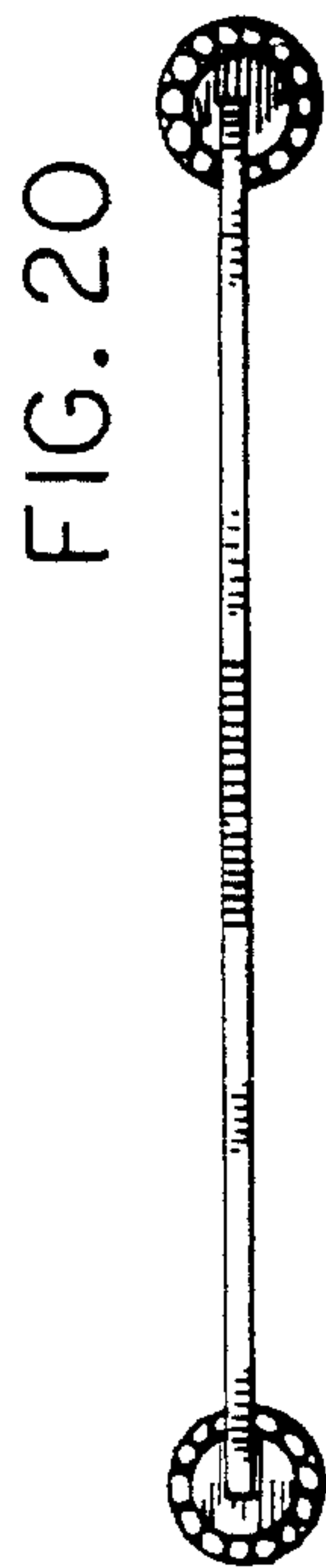

FIG. 20

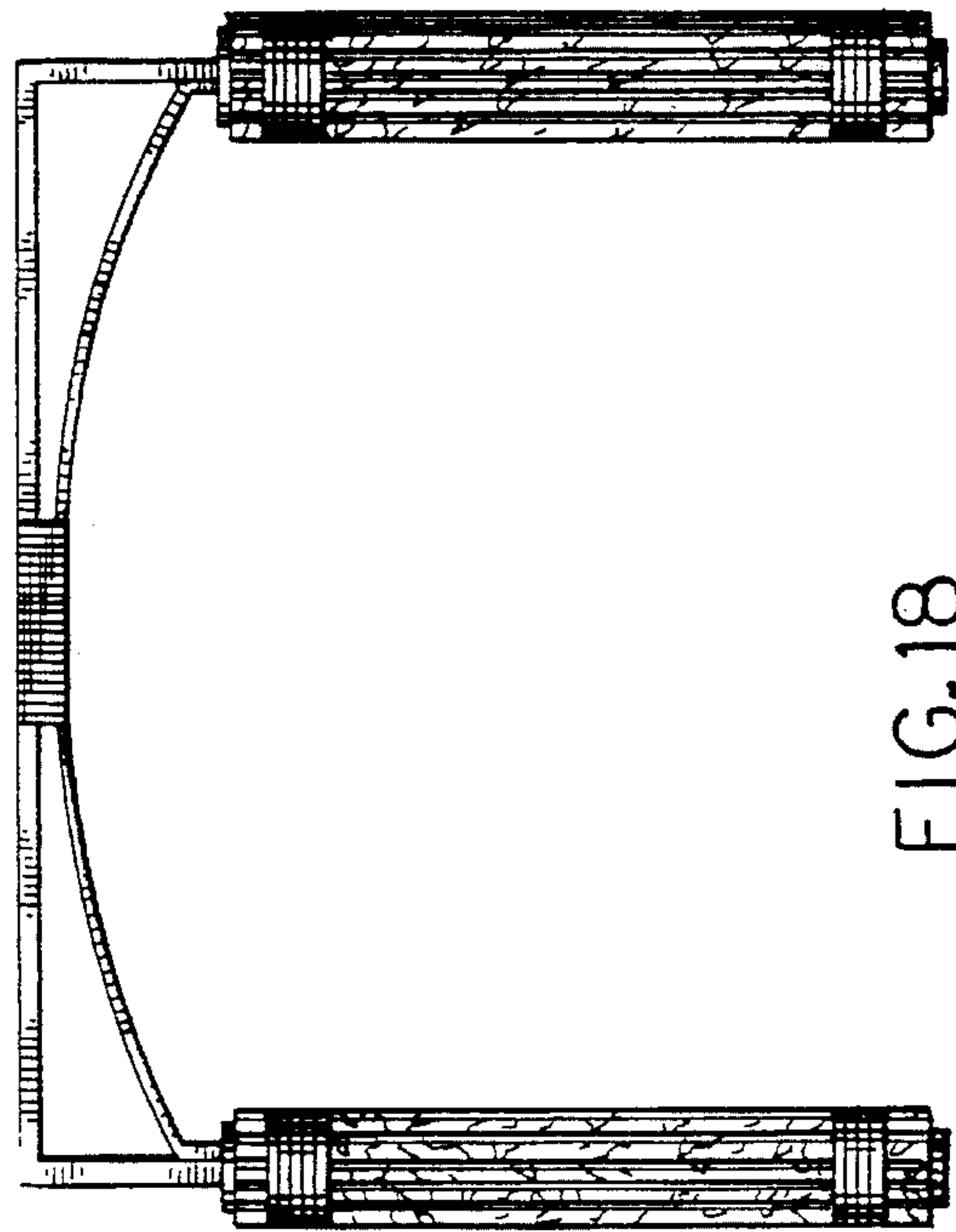

FIG. 18