



US00D367189S

United States Patent [19]

[11] Patent Number: **Des. 367,189**

Tisbo et al.

[45] Date of Patent: ****Feb. 20, 1996**

[54] MID-SIZE BASKETBALL LOCKER

OTHER PUBLICATIONS

[75] Inventors: **Thomas A. Tisbo**, Barrington Hills;
Stephen P. Whitehead, Elgin; **Lyle A. Rosine**, Aurora, all of Ill.

"Lyon Steel Equipment" Catalog, Oct. 1958, p. 2, Item No. 1030, Desk-High Cabinet.

[73] Assignee: **Suncast Corporation**, Batavia, Ill.

Primary Examiner—Alan P. Douglas
Assistant Examiner—Cathron B. Matta
Attorney, Agent, or Firm—McHale & Slavin

[**] Term: **14 Years**

[57] CLAIM

[21] Appl. No.: **22,467**

The ornamental design for a mid-size basketball locker, as shown and described.

[22] Filed: **May 5, 1994**

[52] U.S. Cl. **D6/434**

DESCRIPTION

[58] Field of Search D6/396, 432-448;
D3/254

FIG. 1 is a front view of the mid-size basketball locker showing the new design;

[56] References Cited

U.S. PATENT DOCUMENTS

D. 199,069	9/1964	Sundberg	D6/446
D. 277,148	1/1985	Palka	D6/446 X
D. 286,122	10/1986	Golias	D6/432 X
D. 327,793	7/1992	McGrory	D6/432 X
D. 352,660	11/1994	Stribiak	D6/432 X
4,045,103	8/1977	Paolino	312/198

FIG. 2 is a right side view thereof;

FIG. 3 is a left side view thereof;

FIG. 4 is a rear view thereof;

FIG. 5 is a top view thereof;

FIG. 6 is a bottom view thereof; and,

FIG. 7 is a perspective view thereof.

1 Claim, 2 Drawing Sheets

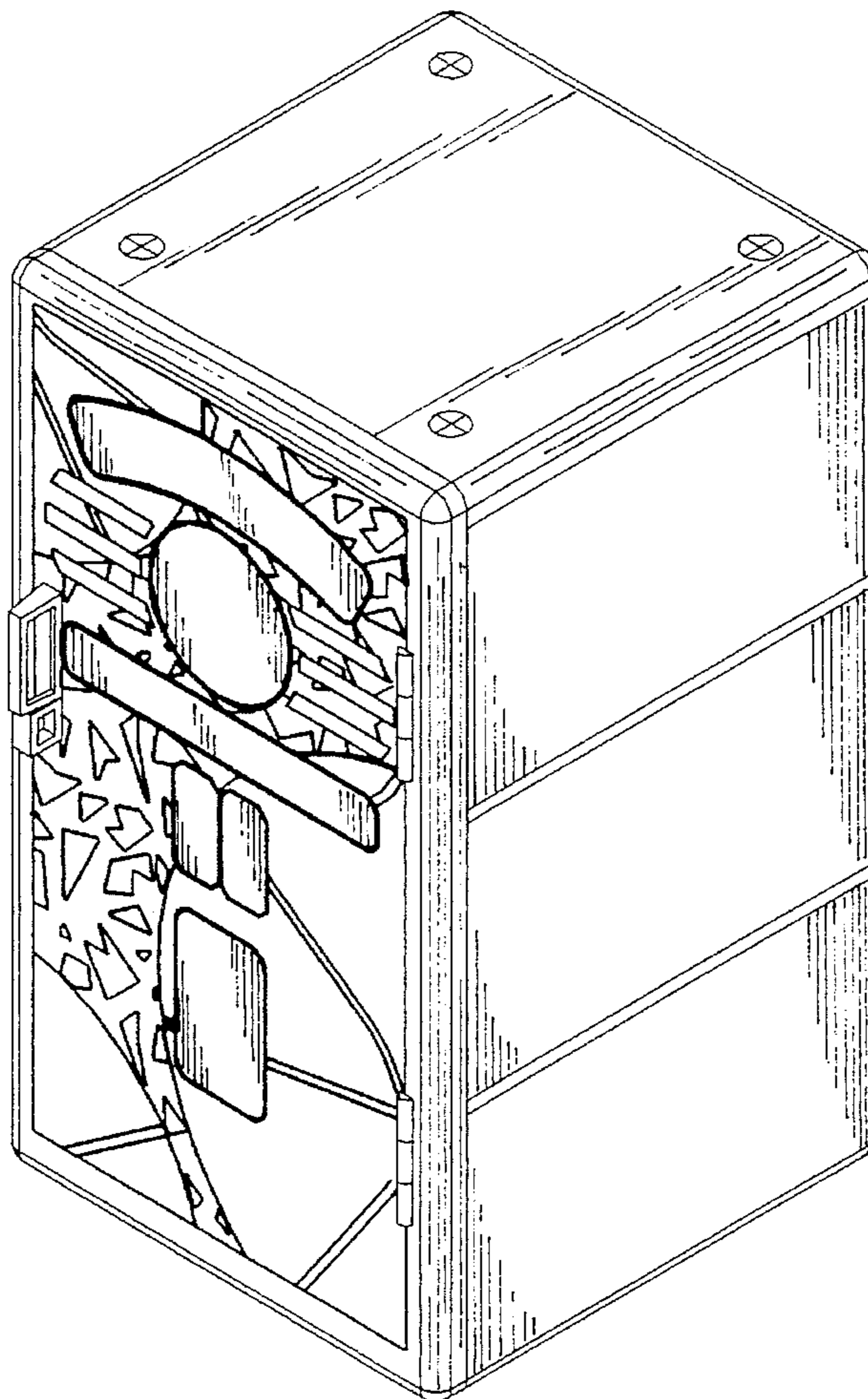

FIG. 4

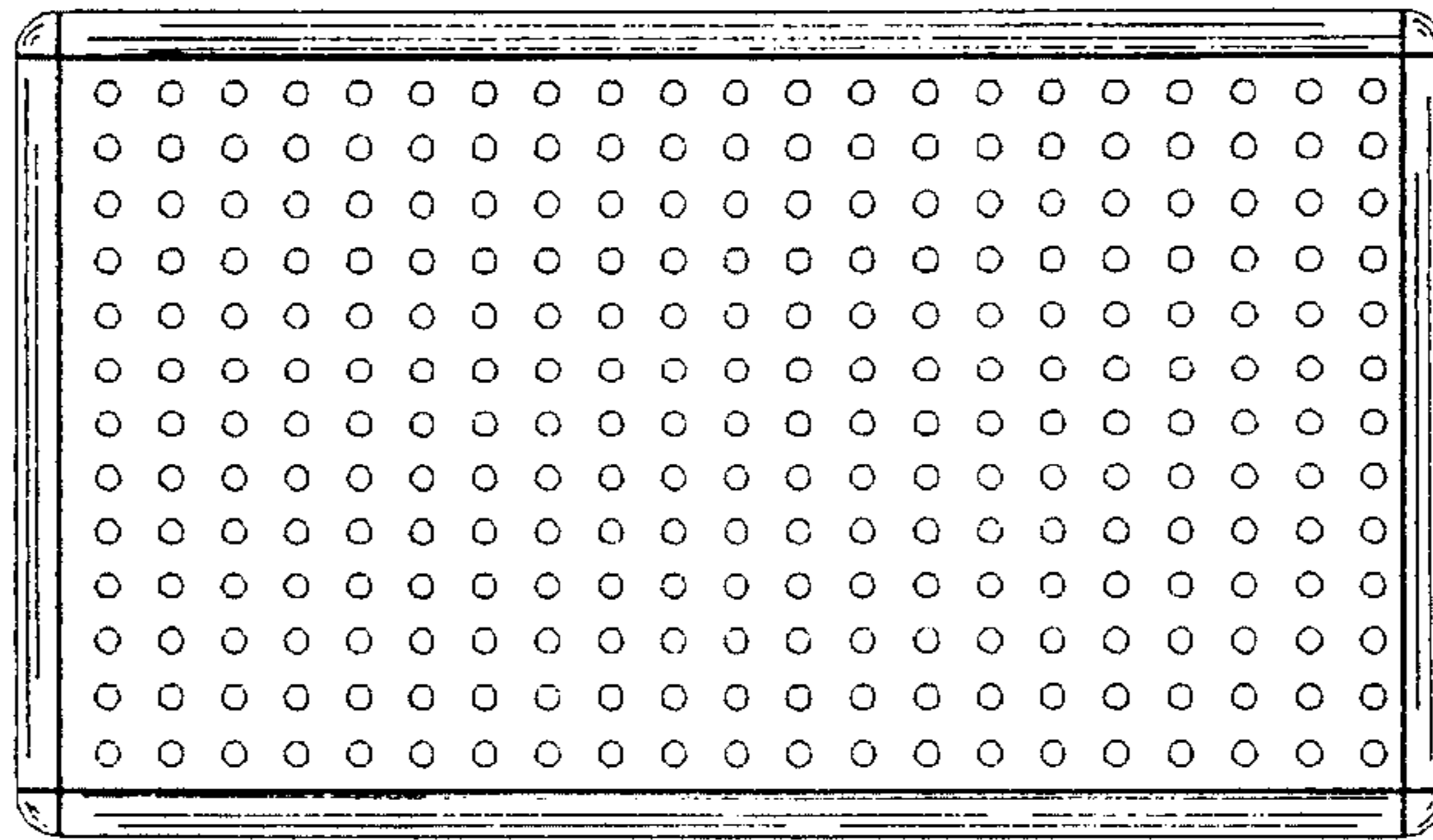

FIG. 3

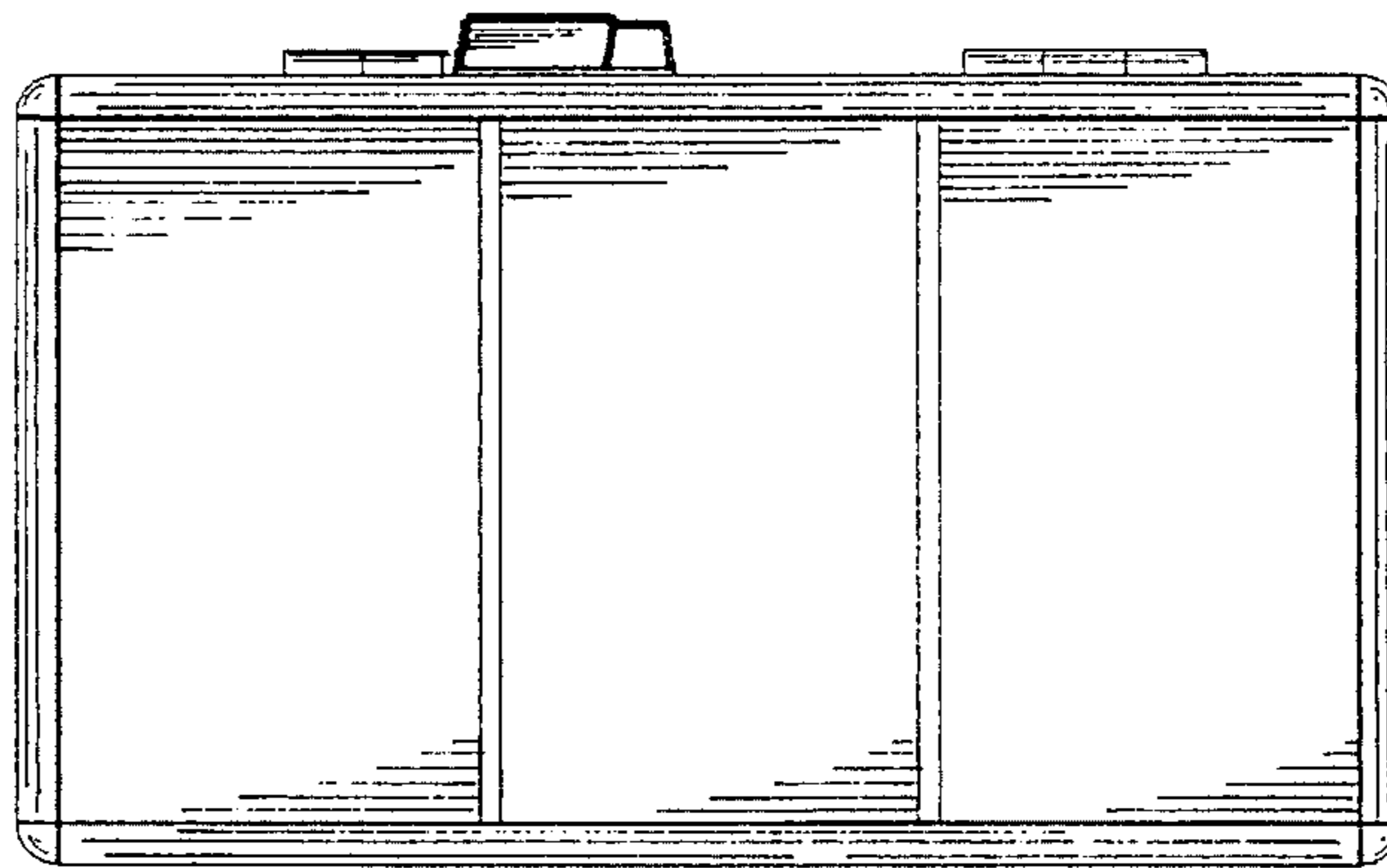

FIG. 2

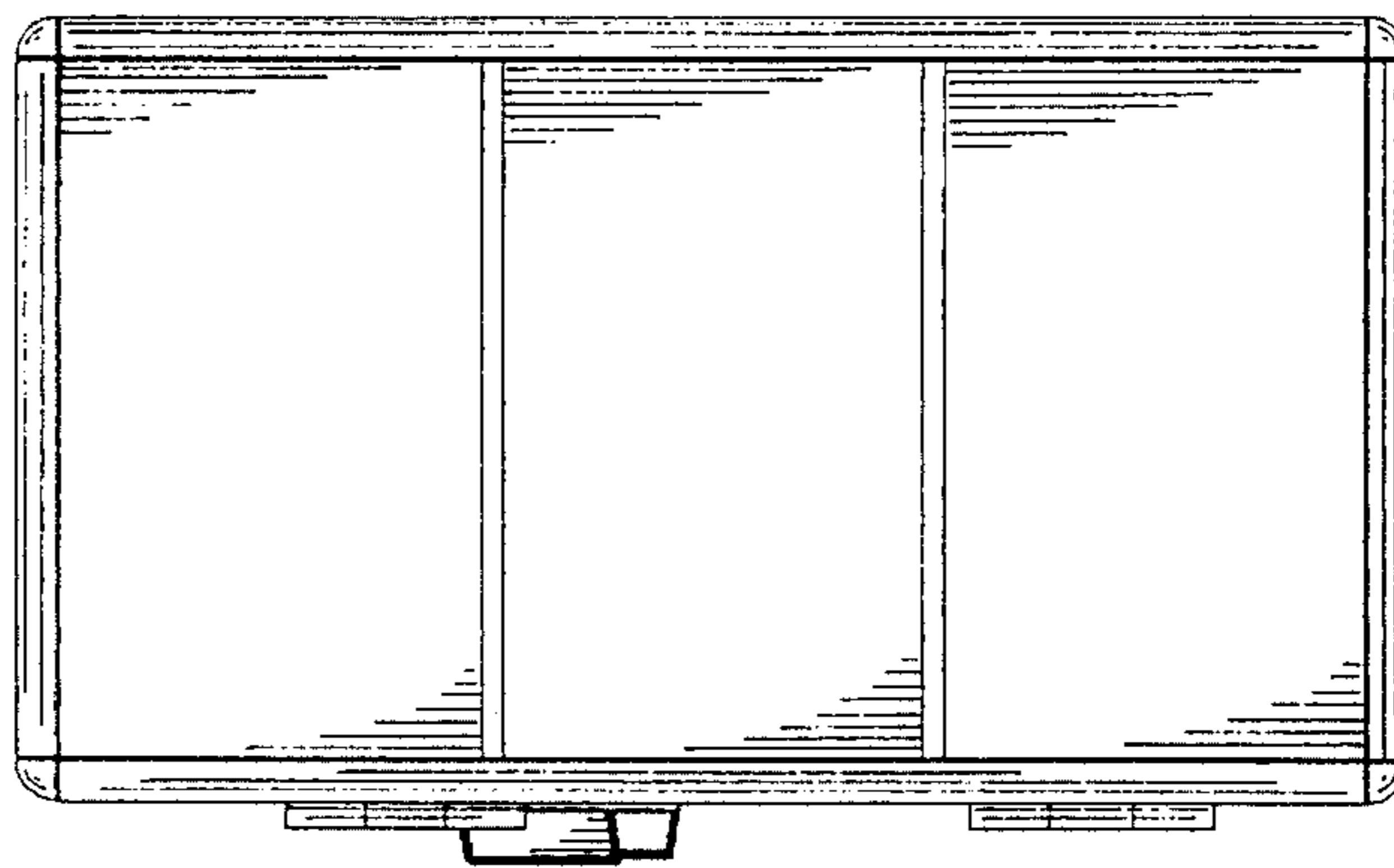

FIG. 1

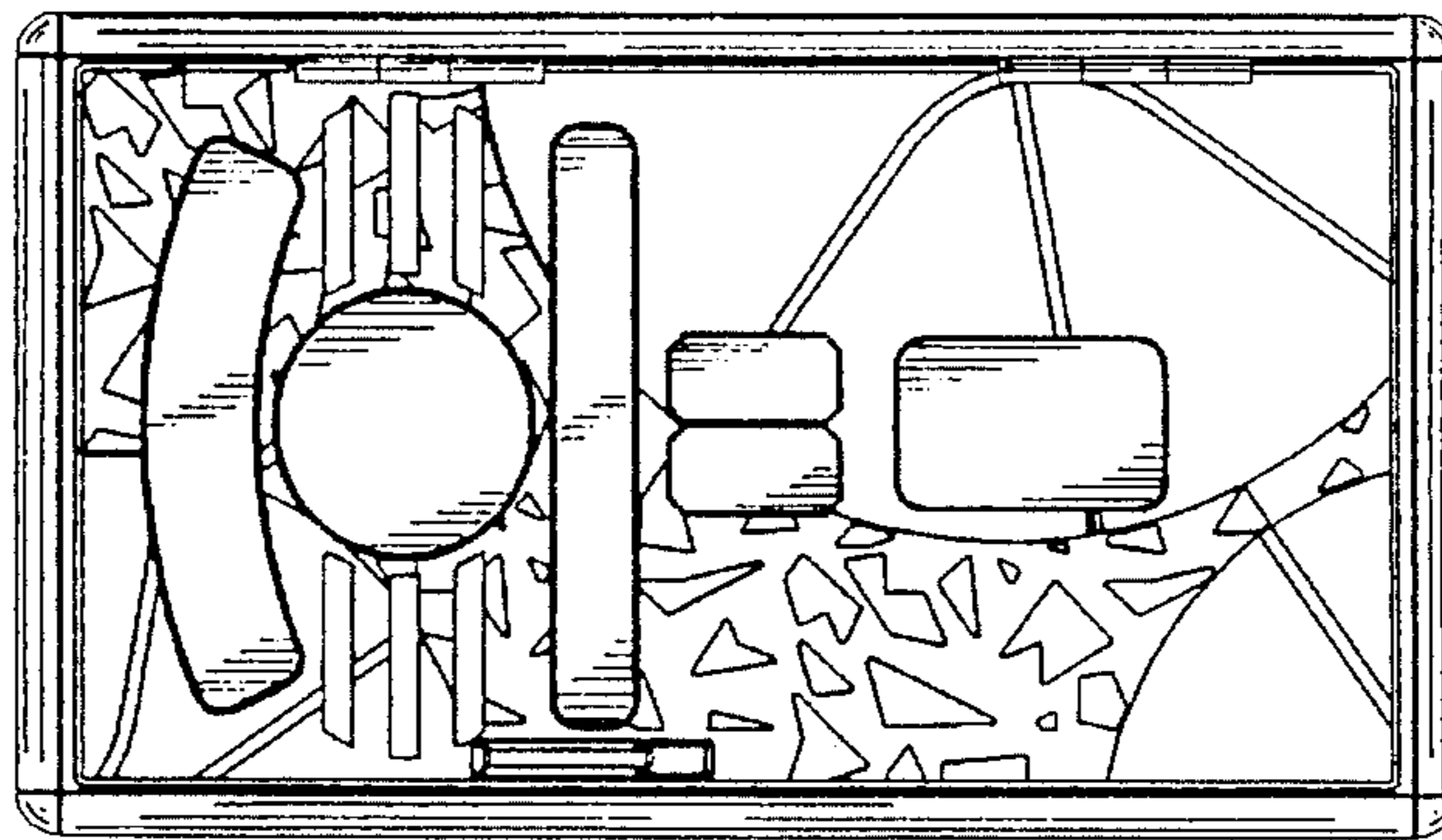

FIG. 5

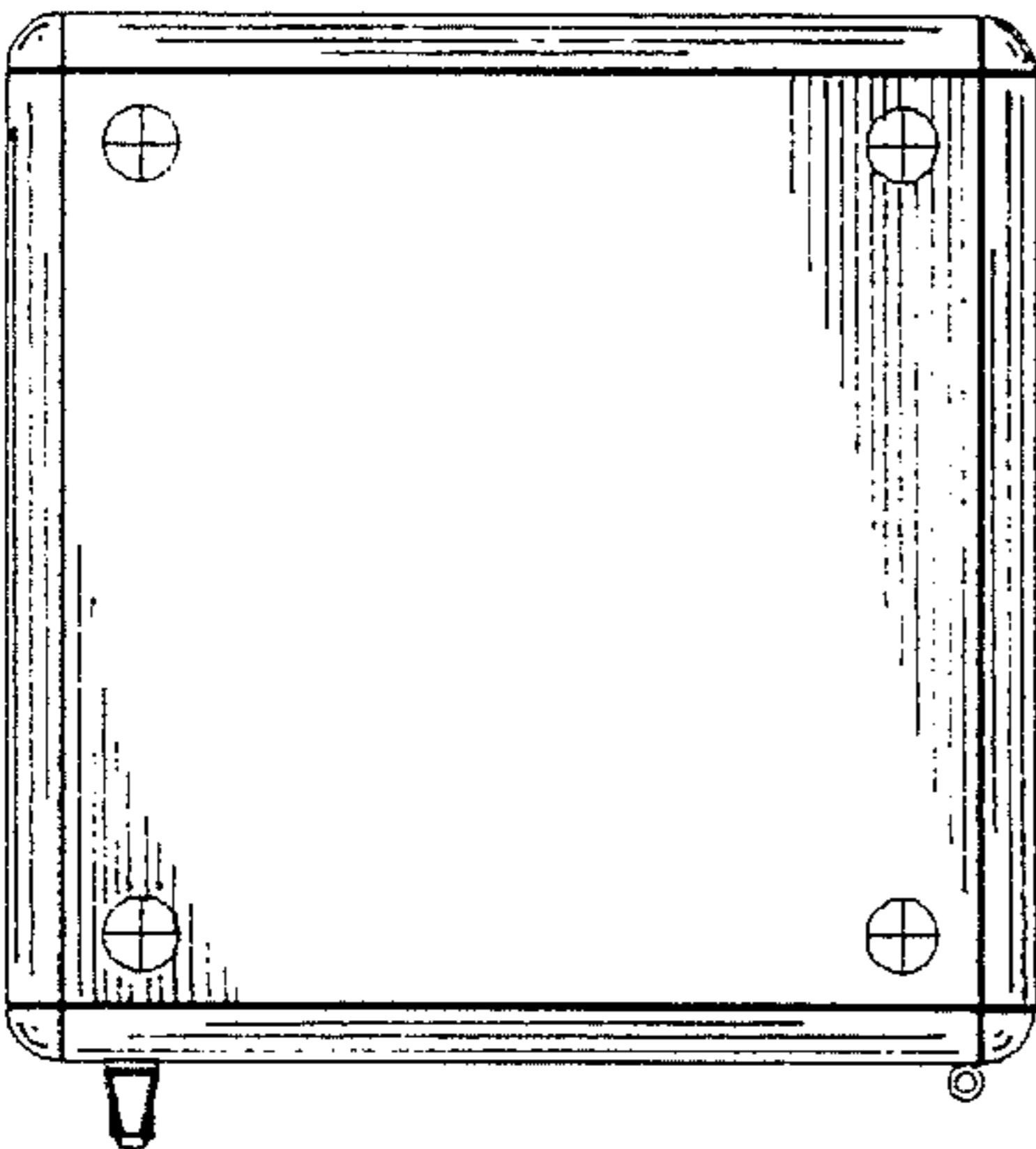

FIG. 6

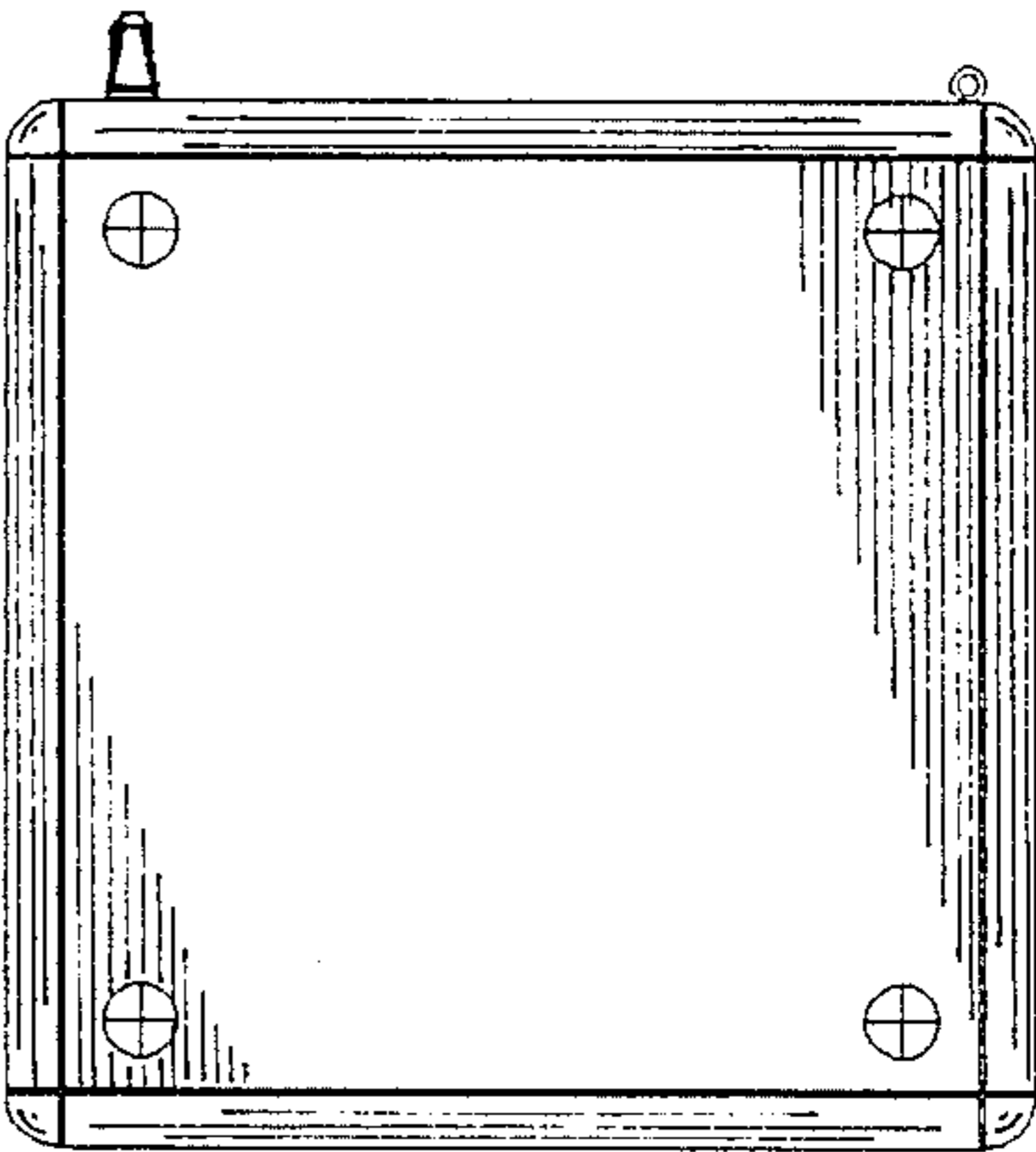

FIG. 7

