



US00D366923S

United States Patent [19]
Boifava

[11] **Patent Number: Des. 366,923**

[45] **Date of Patent: *** Feb. 6, 1996**

[54] **AIRPLANE AMUSEMENT RIDE**

[75] Inventor: **Mario Boifava**, Vicenza, Italy

[73] Assignee: **Zamperla, Inc.**, Parsippany, N.J.

[*] Notice: The portion of the term of this patent subsequent to Aug. 29, 2009, has been disclaimed.

[**] Term: **14 Years**

[21] Appl. No.: **20,317**

[22] Filed: **Mar. 23, 1994**

[52] U.S. Cl. **D21/242**

[58] **Field of Search** D21/240, 242,
D21/250; 446/7, 230, 231; 472/44, 45,
47

[56] **References Cited**

U.S. PATENT DOCUMENTS

D. 165,593	1/1952	Low	D21/246
1,987,004	1/1935	Eyerly	472/44
2,423,283	7/1947	Austin	472/44 X
4,842,267	6/1989	Kastner	272/36

Primary Examiner—Ted Shooman
Assistant Examiner—Mitchell I. Siegel
Attorney, Agent, or Firm—Kenyon & Kenyon

[57] **CLAIM**

The ornamental design for an airplane amusement ride, as shown and described.

DESCRIPTION

FIG. 1 is a perspective view of an airplane amusement ride showing my new design;

FIG. 2 is a bottom perspective view thereof, the arms shown in an alternate position for clarity of illustration;

FIG. 3 is a left side elevational view of FIG. 2;

FIG. 4 is a right side elevational view of FIG. 2;

FIG. 5 is a front elevational view of FIG. 2;

FIG. 6 is a rear elevational view of FIG. 2;

FIG. 7 is a top plan view of FIG. 2; and,

FIG. 8 is a bottom plan view of FIG. 2.

The broken line showing of background display board and posts is for illustrative purposes only and forms no part of the claimed design.

1 Claim, 6 Drawing Sheets

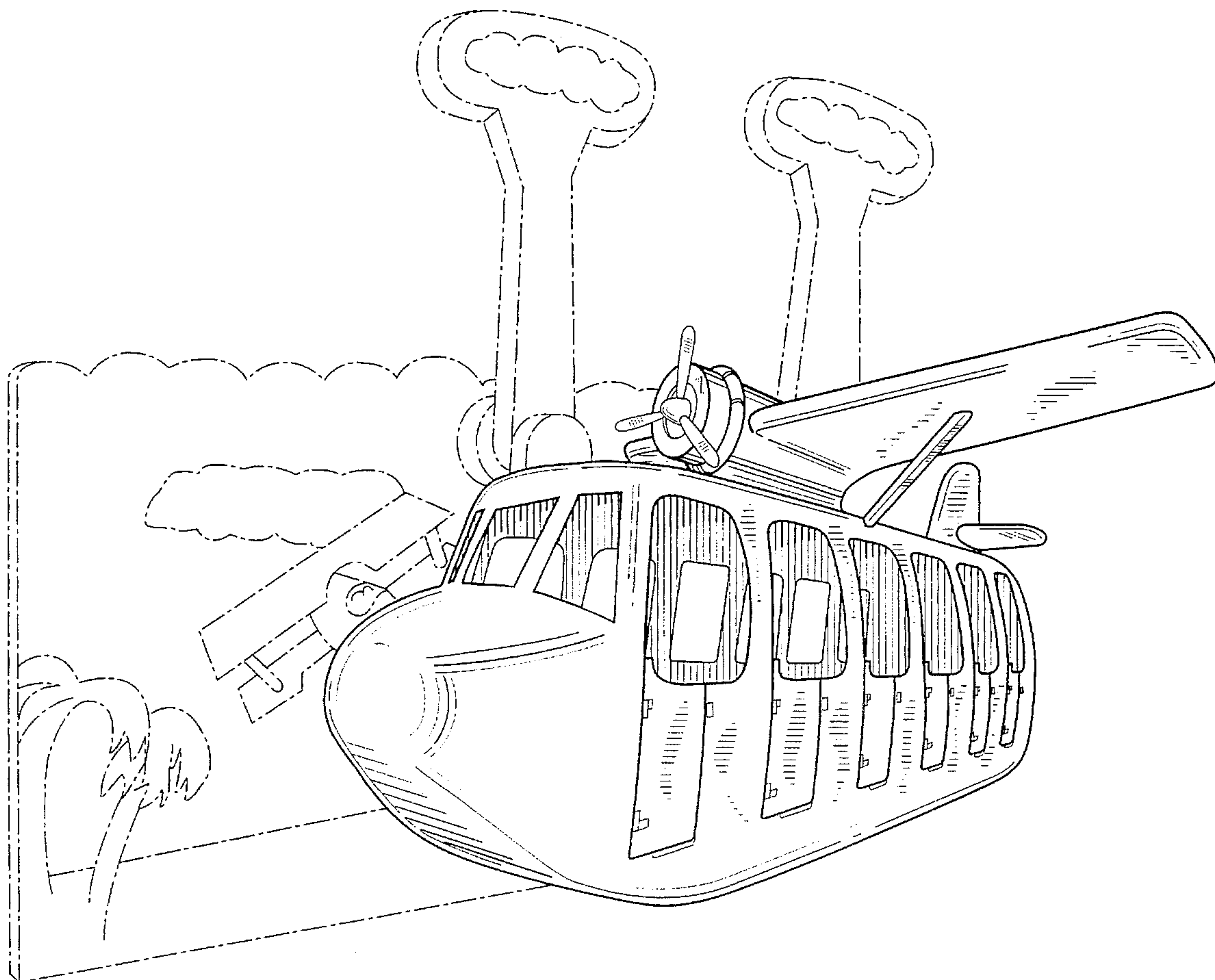

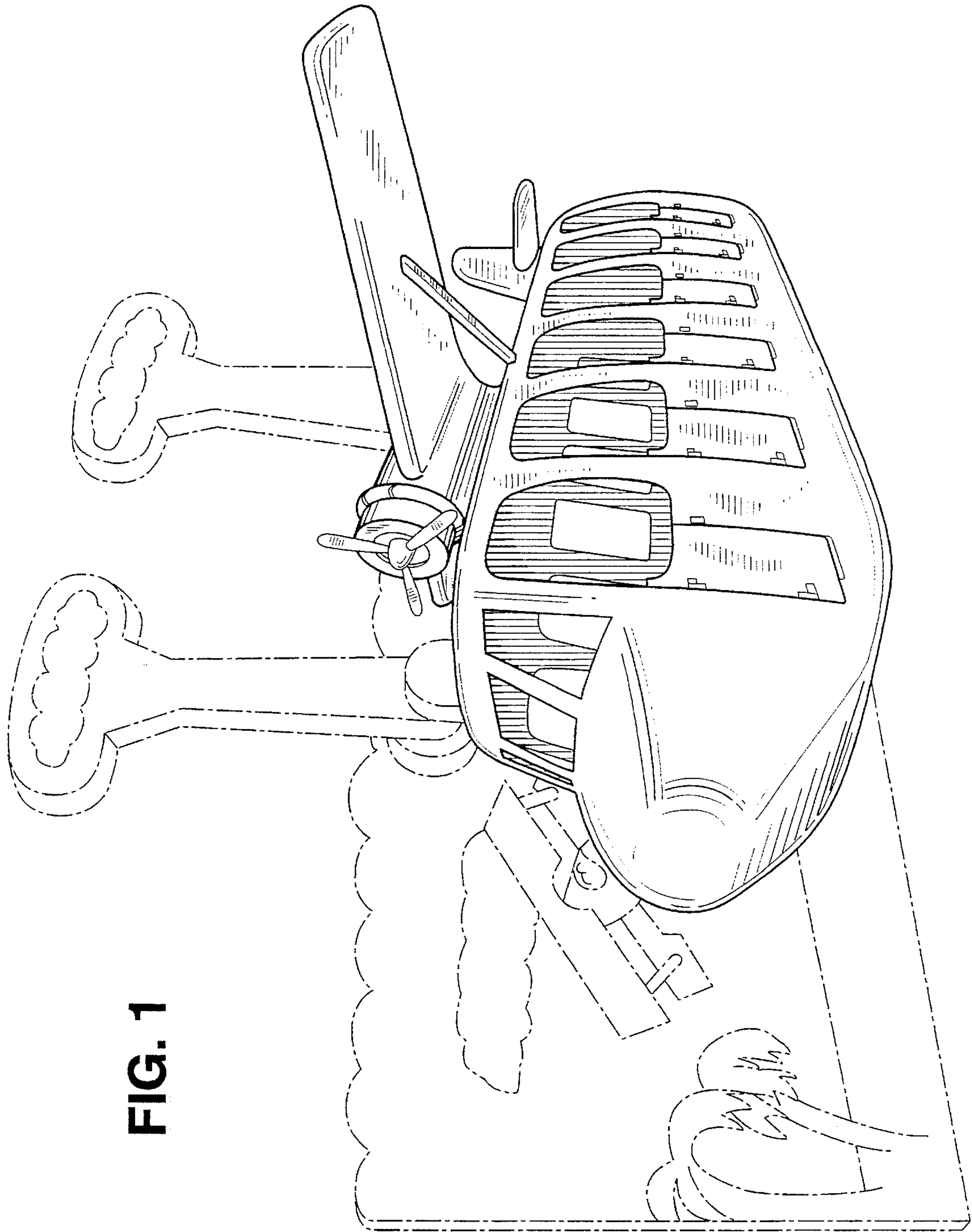

FIG. 1

FIG. 2

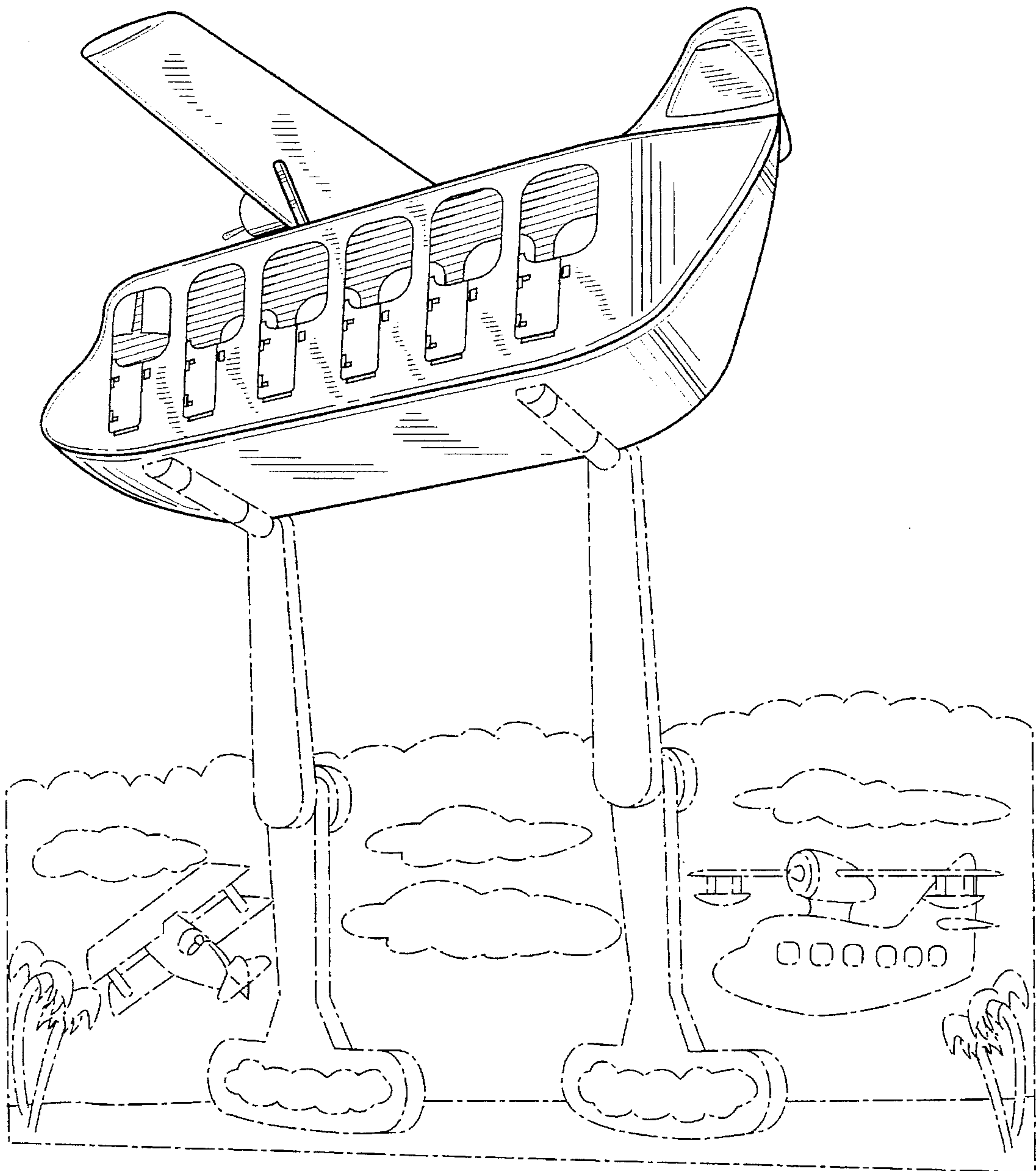

FIG. 3

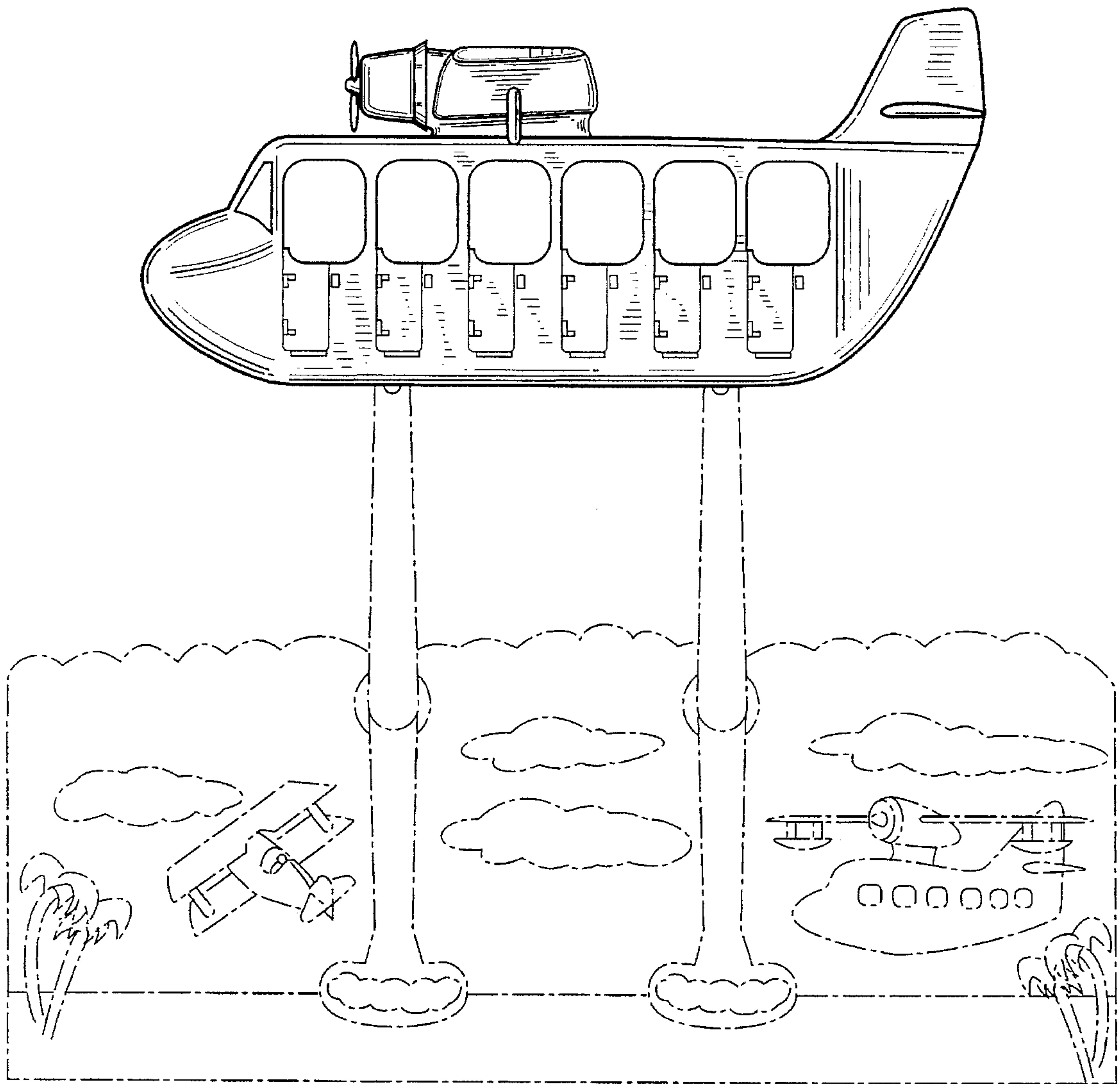
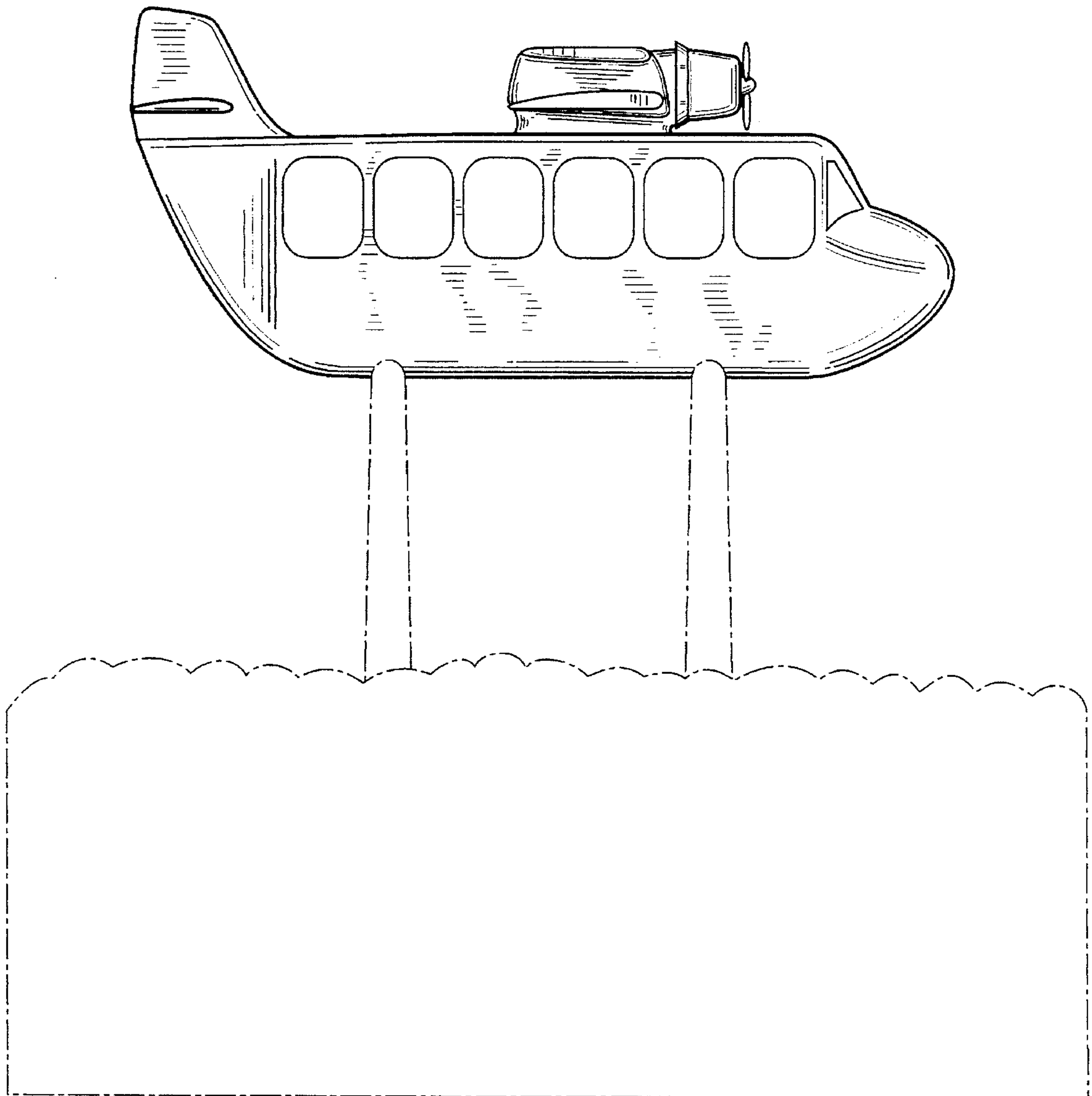

FIG. 4



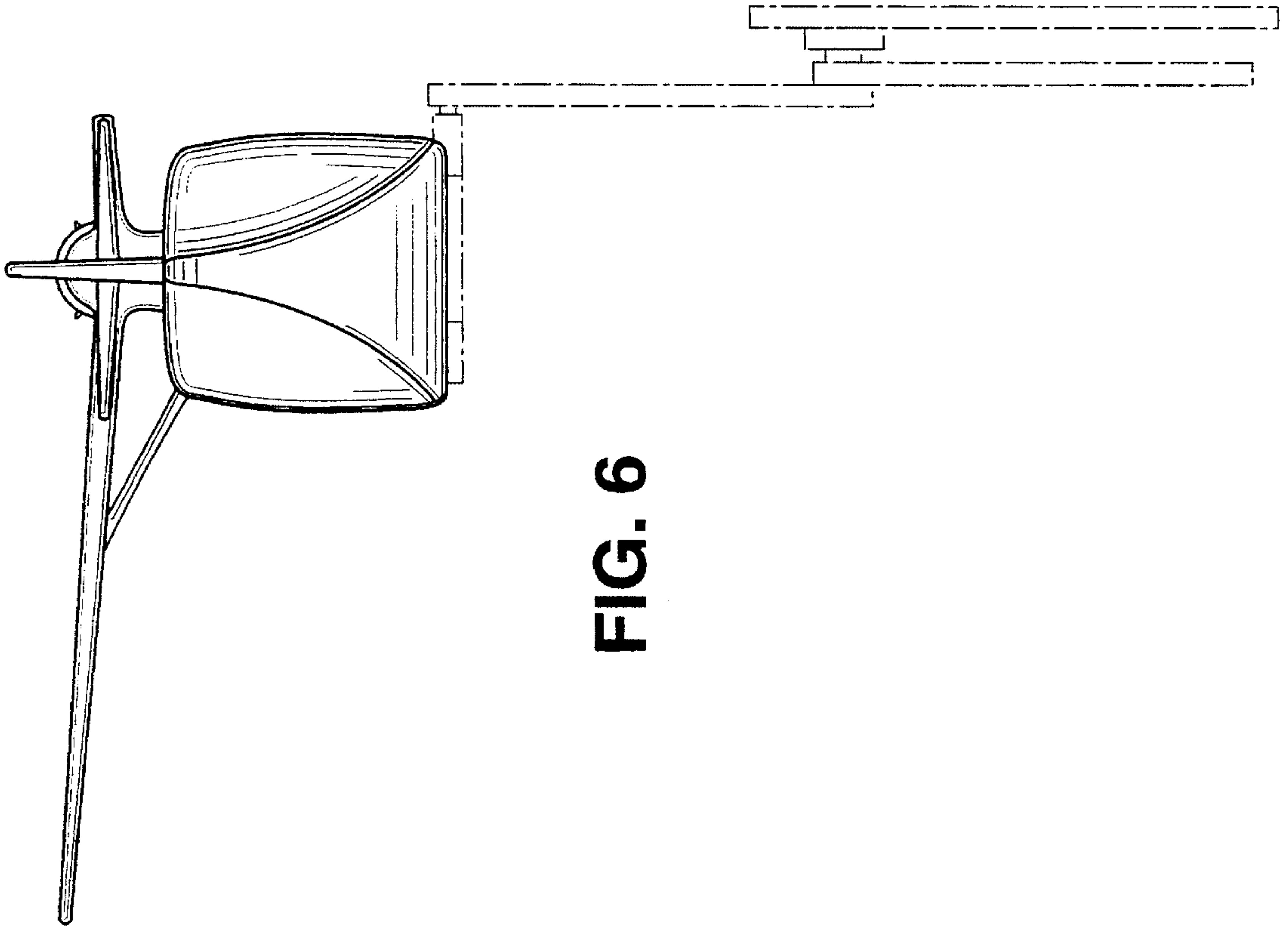

FIG. 6

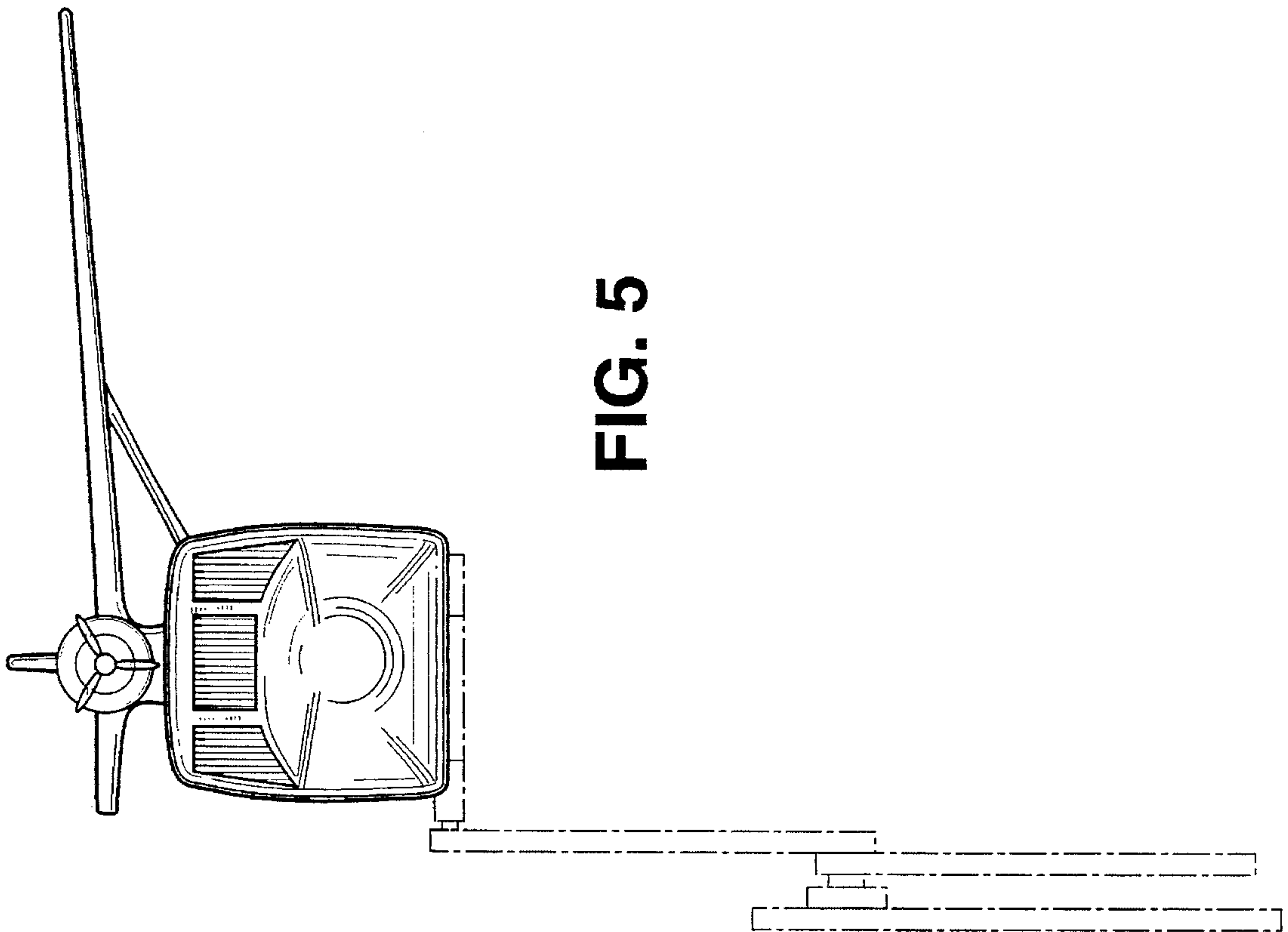

FIG. 5

FIG. 8

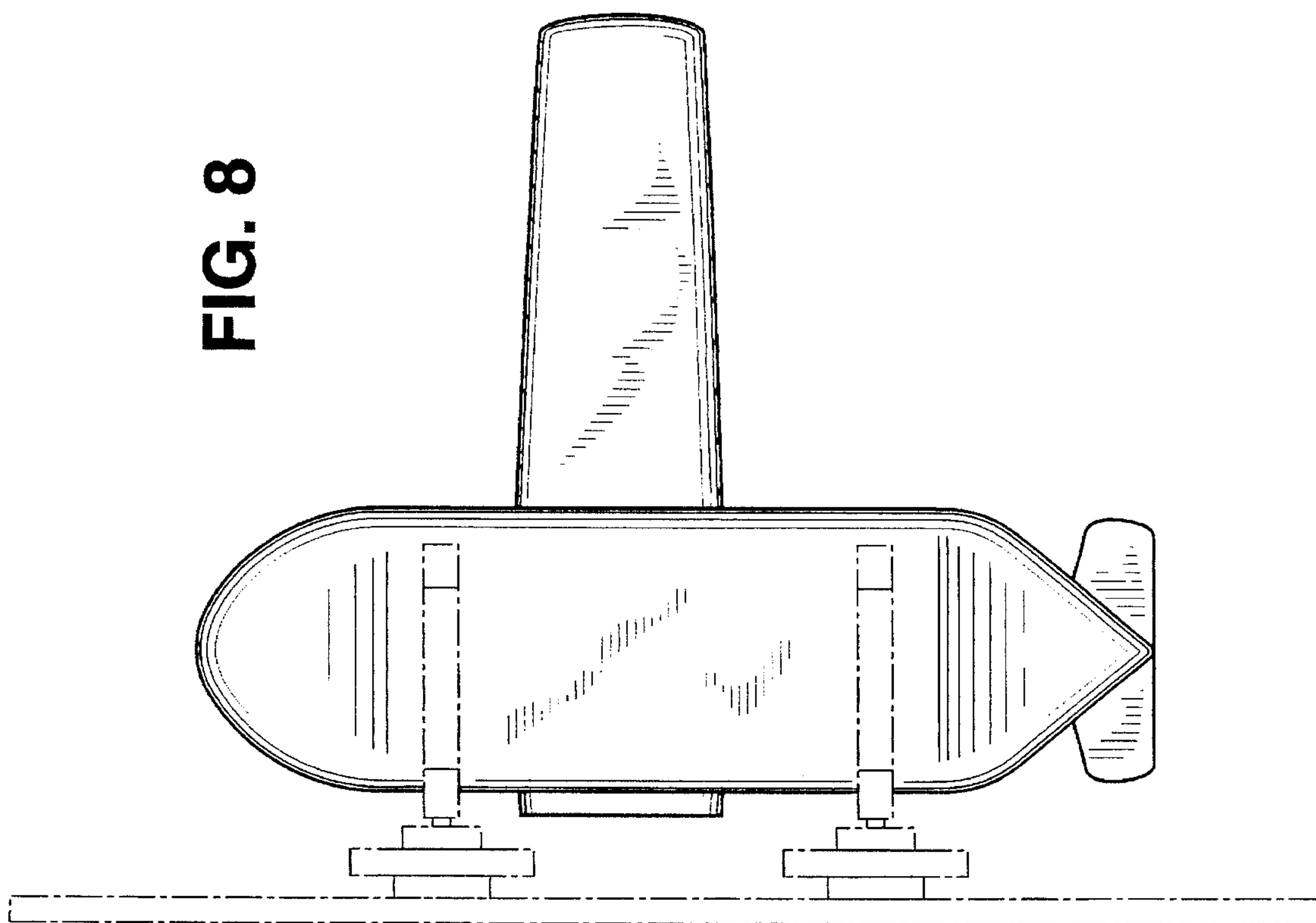

FIG. 7

