



US00D366895S

United States Patent [19] Takahashi

[11] **Patent Number: Des. 366,895**
[45] **Date of Patent: **Feb. 6, 1996**

[54] **ELECTRONIC COPYING MACHINE**

D. 339,801 9/1993 Urushihara et al. D18/36 X
D. 354,509 1/1995 Komada et al. D18/36
D. 354,510 1/1995 Ishibashi et al. D18/36

[75] Inventor: **Masaki Takahashi**, Kawasaki, Japan

[73] Assignee: **Canon Kabushiki Kaisha**, Tokyo, Japan

Primary Examiner—Alan P. Douglas
Assistant Examiner—S. Snapp
Attorney, Agent, or Firm—Fitzpatrick, Cella, Harper & Scinto

[**] Term: **14 Years**

[21] Appl. No.: **33,358**

[57] **CLAIM**

[22] Filed: **Jan. 11, 1995**

The ornamental design for an electronic copying machine, as shown and described.

[30] **Foreign Application Priority Data**

DESCRIPTION

Jul. 13, 1994 [JP] Japan 6-21093

[52] **U.S. Cl.** **D18/36**

[58] **Field of Search** D18/36-46; 355/200, 355/210, 233, 234, 235, 245, 326 R, 327

FIG. 1 is a front elevational view of an electronic copying machine showing my new design;
FIG. 2 is a rear elevational view thereof;
FIG. 3 is a top plan view thereof;
FIG. 4 is a bottom plan view thereof;
FIG. 5 is a left side elevational view thereof;
FIG. 6 is a right side elevational view thereof; and,
FIG. 7 is a perspective view thereof.

[56] **References Cited**

U.S. PATENT DOCUMENTS

D. 302,007 7/1989 Hara et al. D18/36 X
D. 305,775 1/1990 Tamada D18/36
D. 321,206 10/1991 Komada et al. D18/36

1 Claim, 3 Drawing Sheets

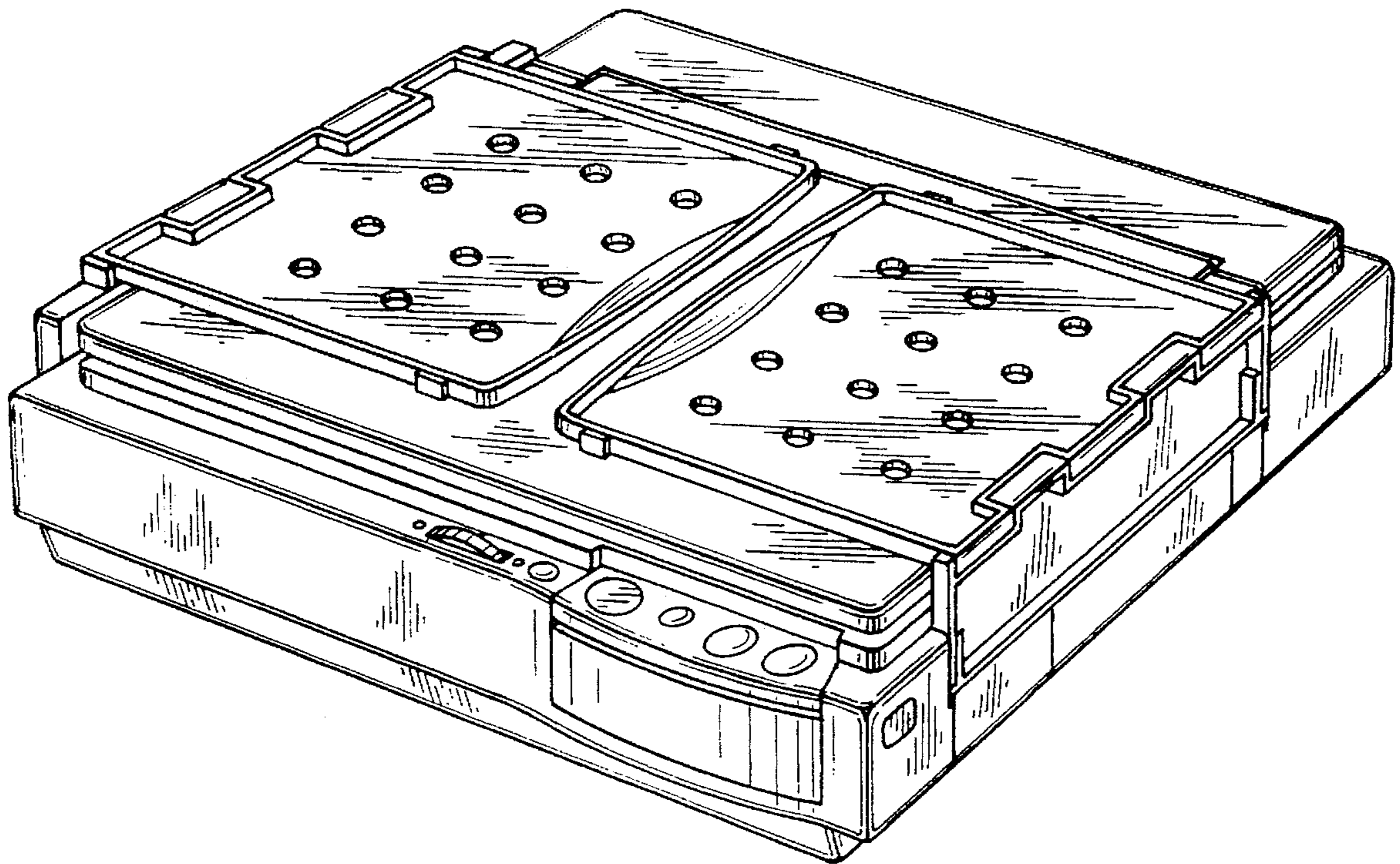

FIG. 1

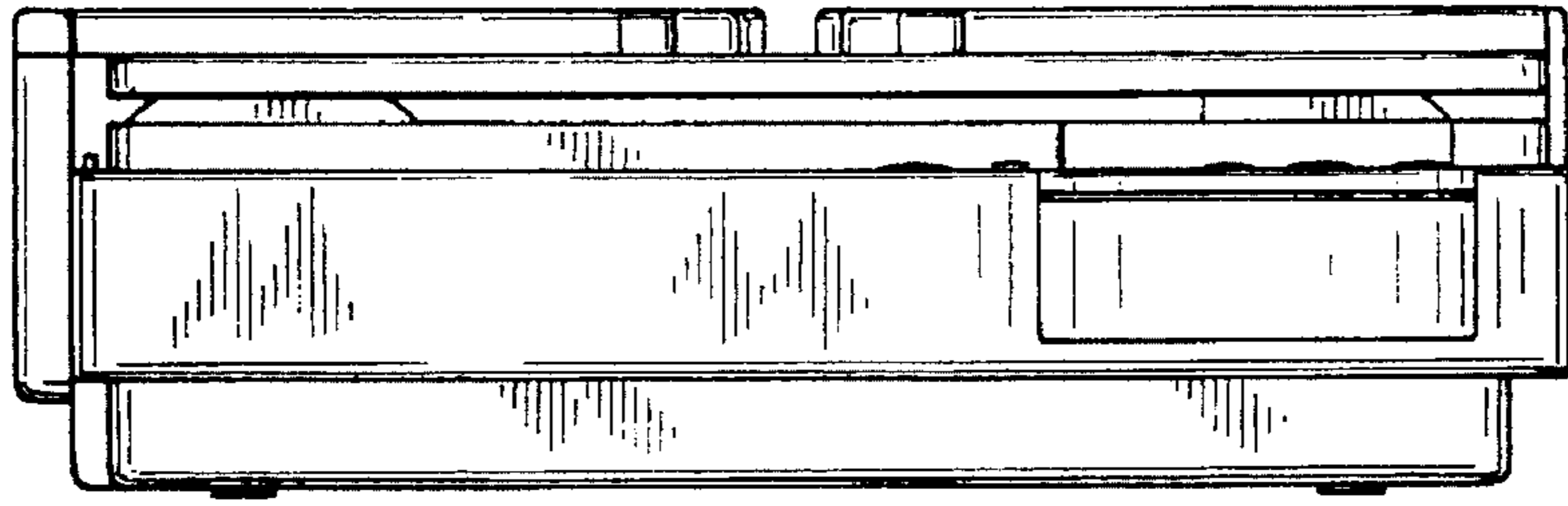

FIG. 2

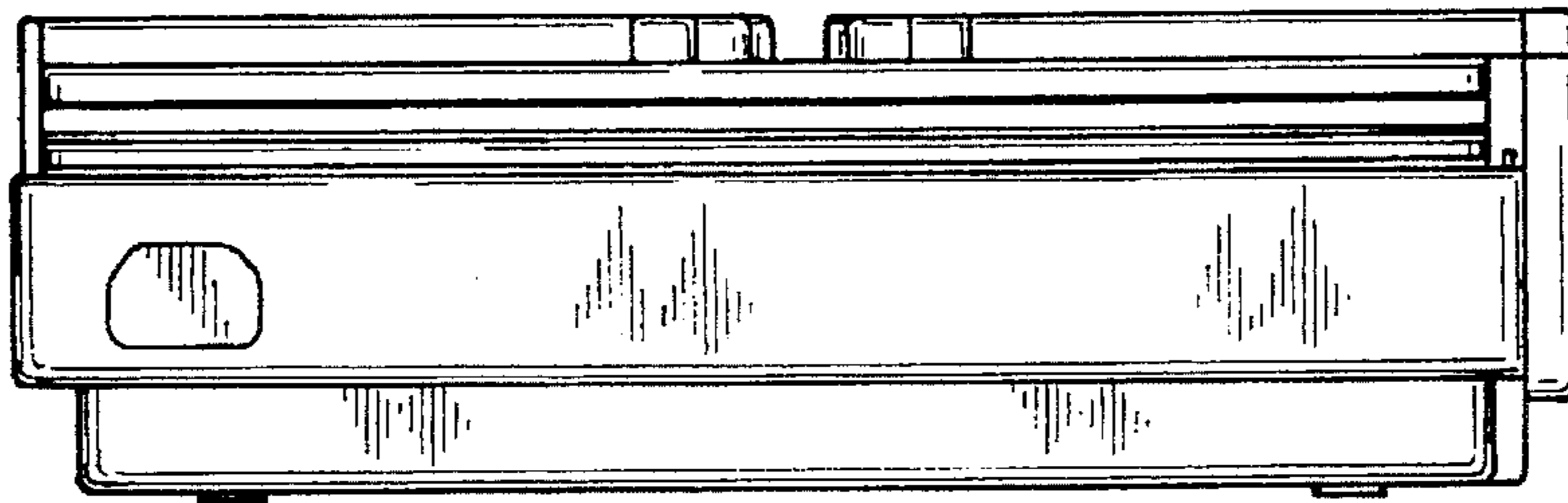

FIG. 3

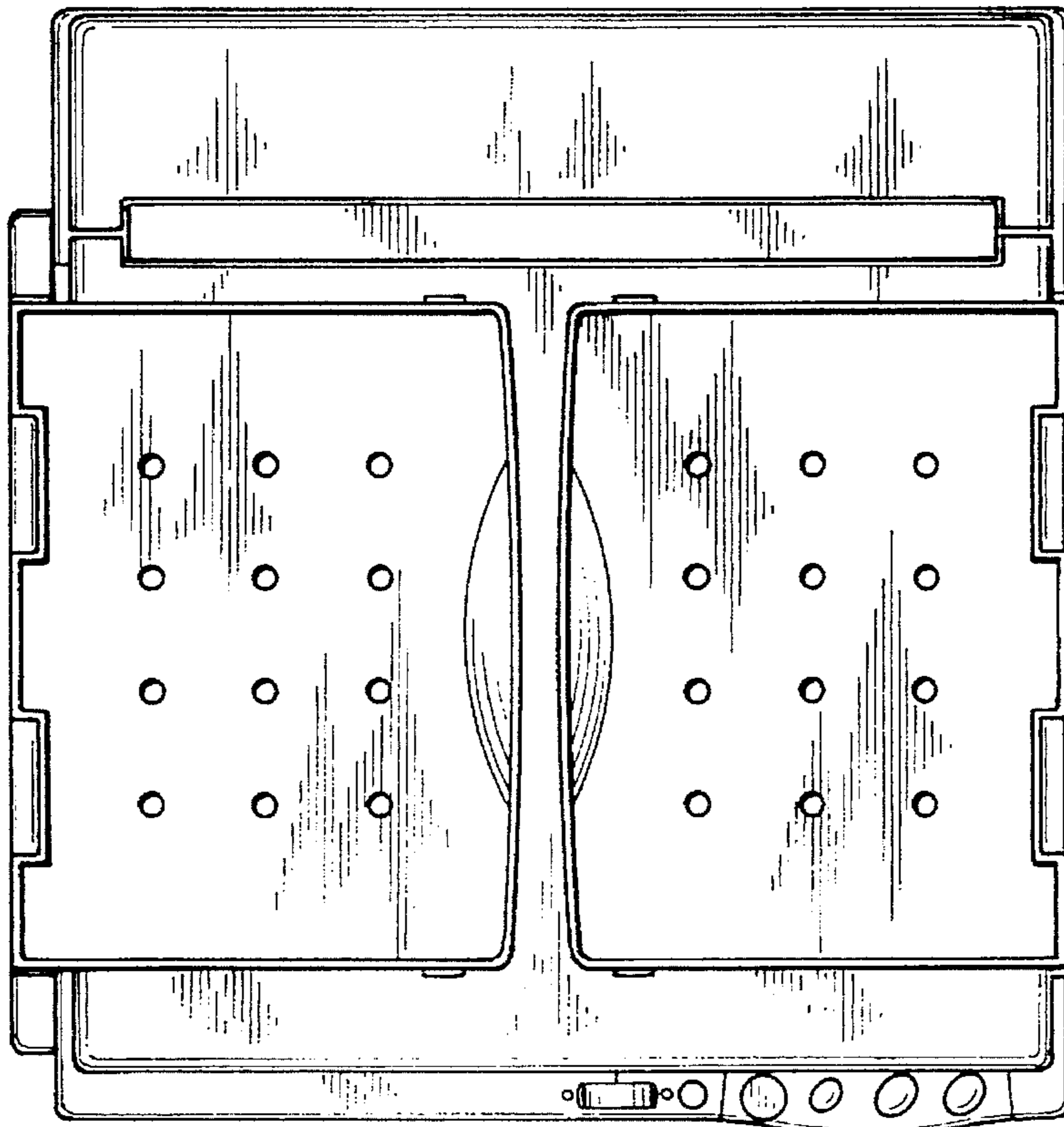

FIG. 4

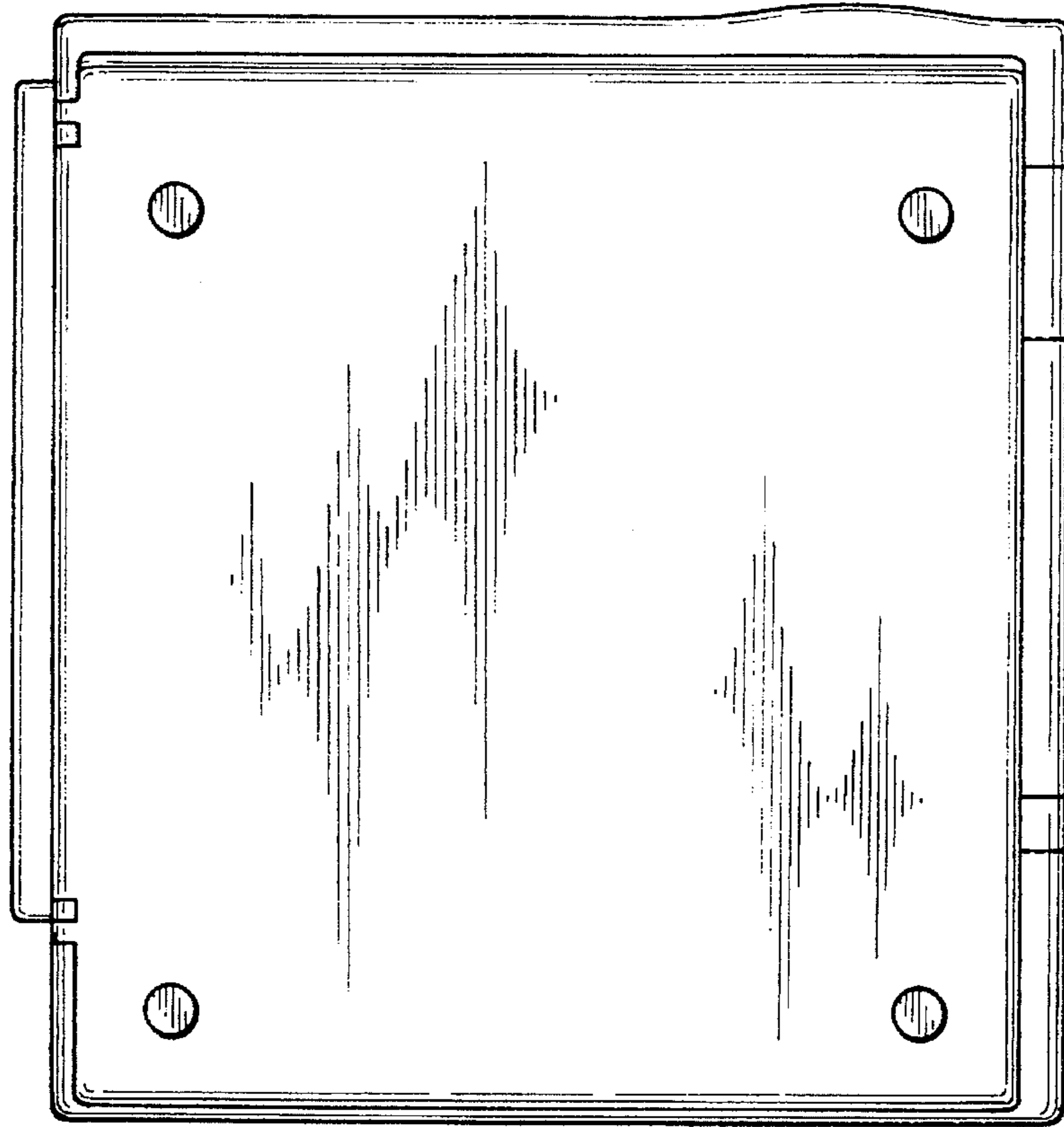

FIG. 5

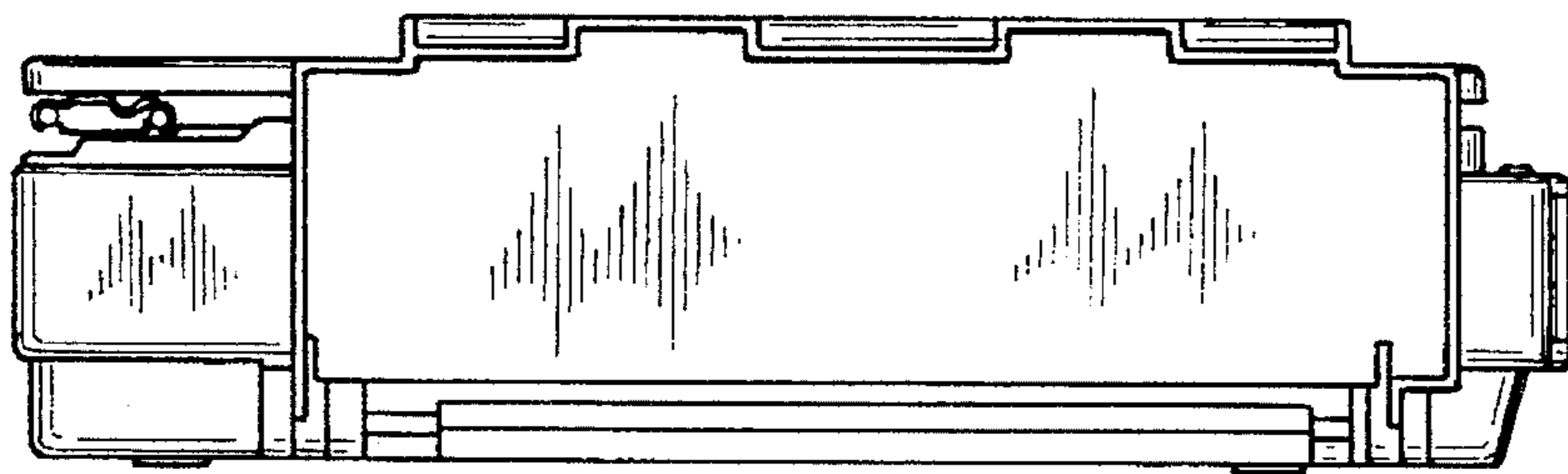

FIG. 6

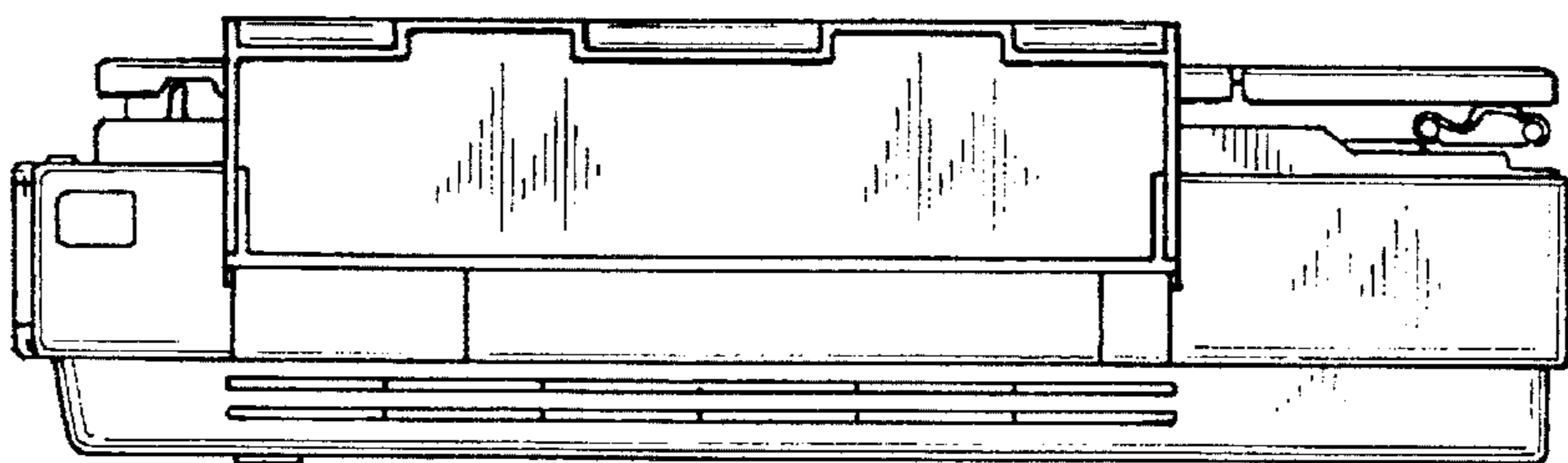

FIG. 7

