



US00D366888S

United States Patent [19]

Locquiao

[11] **Patent Number:** **Des. 366,888**

[45] **Date of Patent:** ****Feb. 6, 1996**

[54] **COMBINED SPECTACLES AND TIMEPIECE**

5,184,156 2/1993 Black et al. 351/44

[76] Inventor: **Benjamin J. Locquiao**, 41-011 Hinalea St., Waimanalo, Hi. 96795

OTHER PUBLICATIONS

Optician, Jun. 1, 1973 p. 23, Spectacles #5061 left side of page.

[**] Term: **14 Years**

Primary Examiner—Prabhakar G. Deshmukh

Assistant Examiner—R. Barkai

[21] Appl. No.: **26,505**

[22] Filed: **Jul. 29, 1994**

[57] **CLAIM**

[52] U.S. Cl. **D16/309**

The ornamental design for a combined spectacles and timepiece, as shown and described.

[58] **Field of Search** D16/304, 306, D16/307, 310, 312, 314, 309, 322-329, 332, 333, 335; D10/2, 31; 351/44, 47, 51, 158; 381/25, 68, 68.5; 368/10, 276-279

DESCRIPTION

[56] **References Cited**

U.S. PATENT DOCUMENTS

| | | | | |
|------------|---------|-----------|-------|---------|
| D. 261,662 | 11/1981 | Bedwell | | D16/306 |
| D. 309,149 | 7/1990 | Pouilloux | | D16/326 |
| D. 352,051 | 11/1994 | Rodriguez | | D16/309 |
| D. 352,513 | 11/1994 | Schwartz | | D16/309 |
| D. 354,969 | 1/1995 | Garcia | | D16/309 |
| 4,867,551 | 9/1989 | Perera | | 351/57 |
| 5,013,145 | 5/1991 | Croll | | 351/51 |

FIG. 1 is a front elevational view of the combined spectacles and timepiece showing my new design;
FIG. 2 is a rear elevational view thereof;
FIG. 3 is a left side elevational view thereof;
FIG. 4 is a right side elevational view thereof;
FIG. 5 is a top plan view thereof;
FIG. 6 is a bottom plan view thereof; and,
FIG. 7 is a sectional view thereof taken along the line 7—7 in FIG. 5.

1 Claim, 4 Drawing Sheets

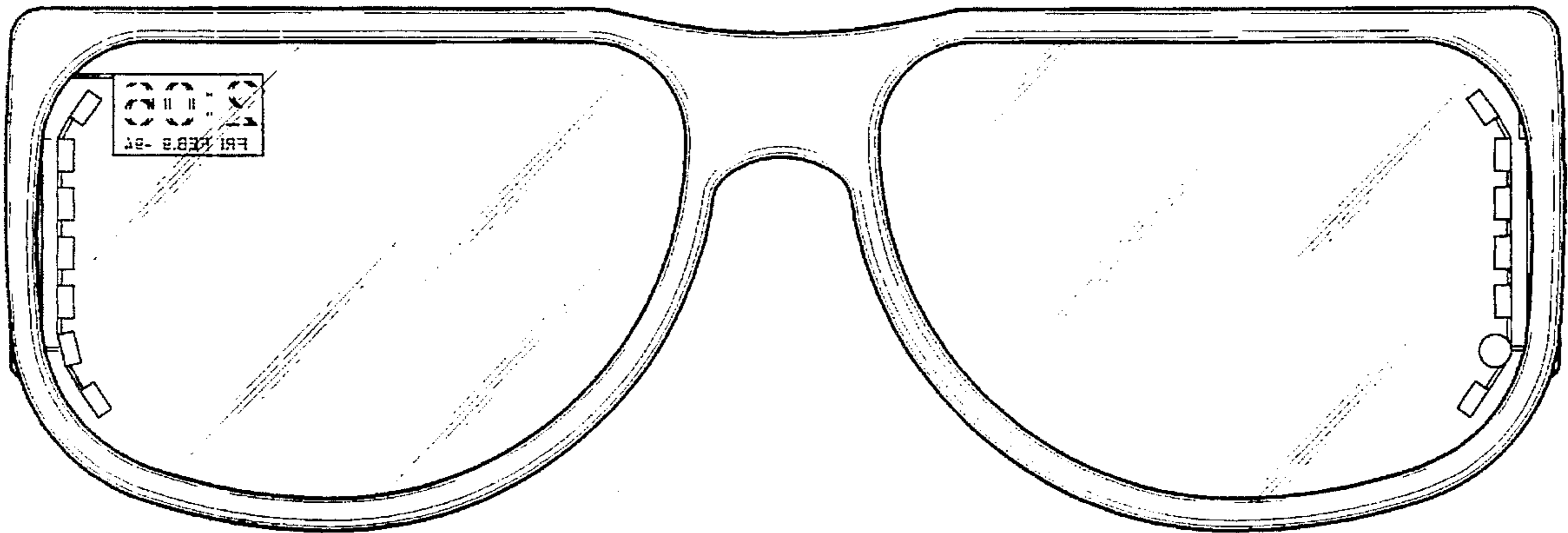

FIG. 1

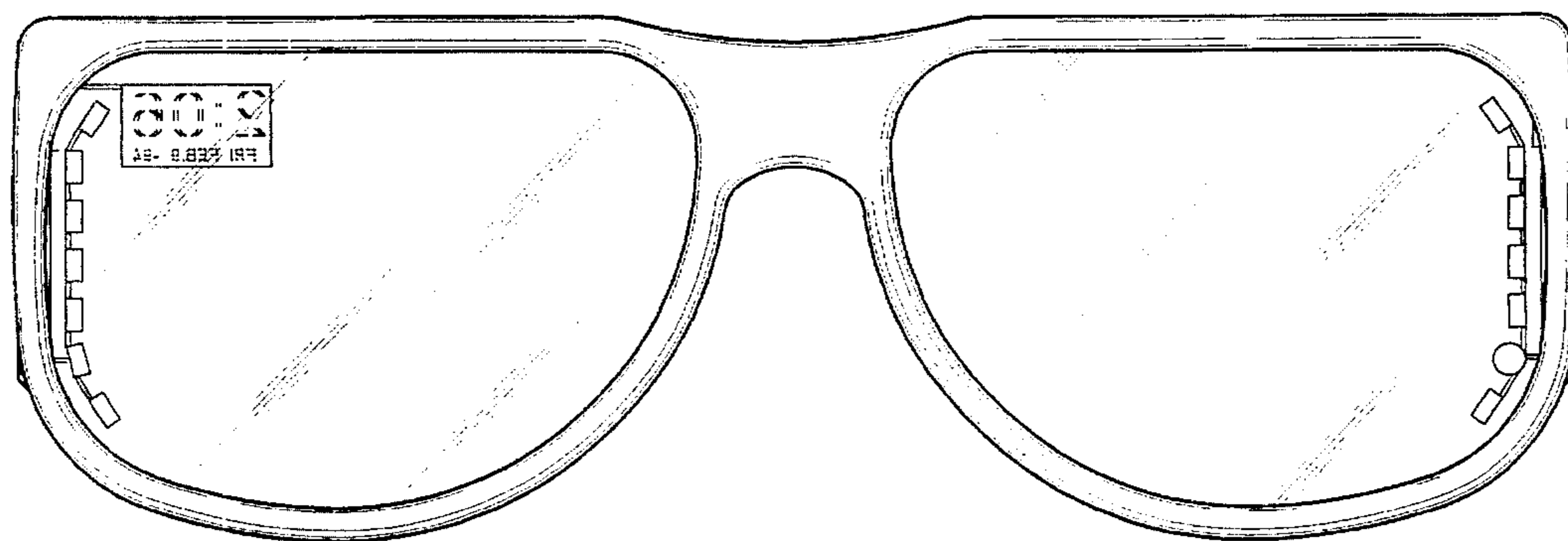

FIG. 2

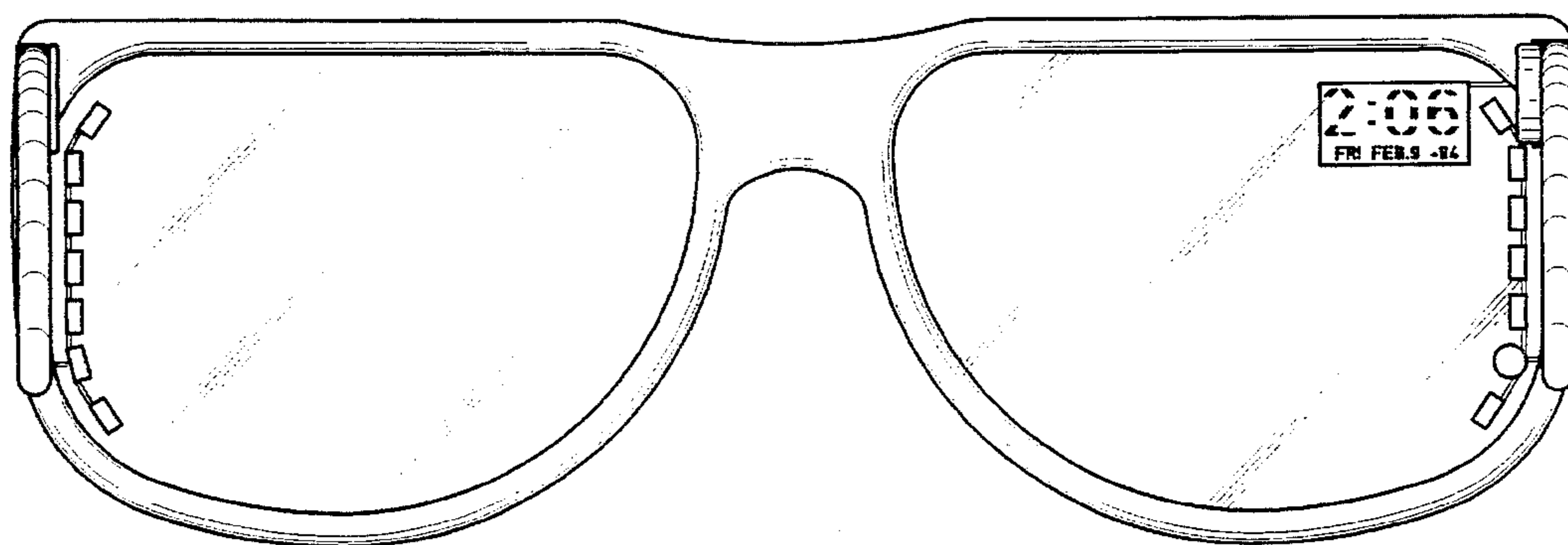

FIG. 3

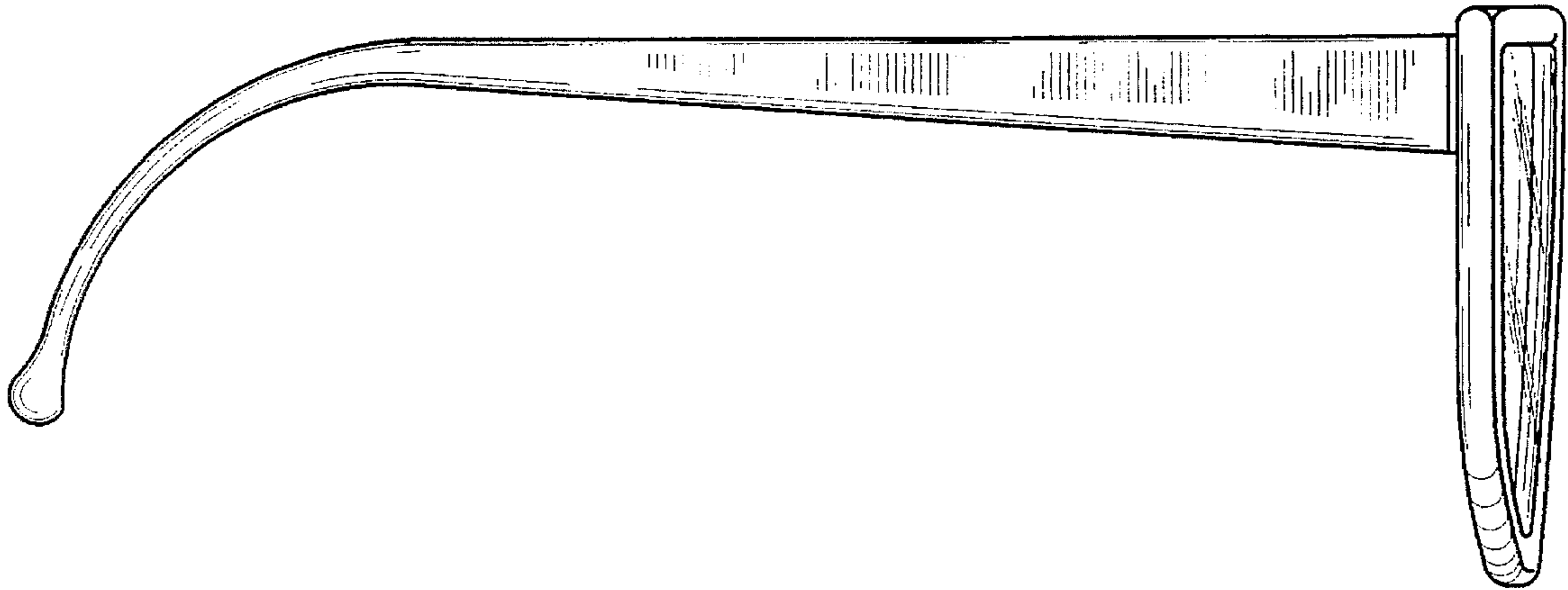

FIG. 4

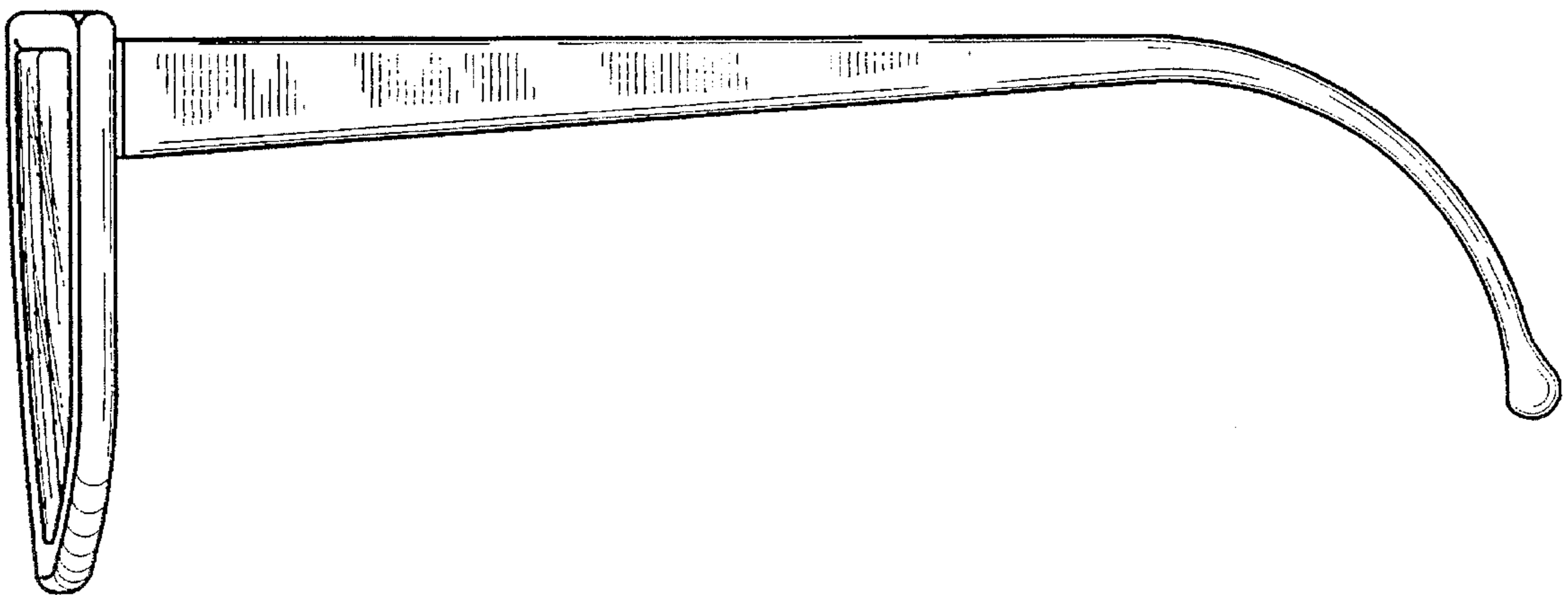

FIG. 5

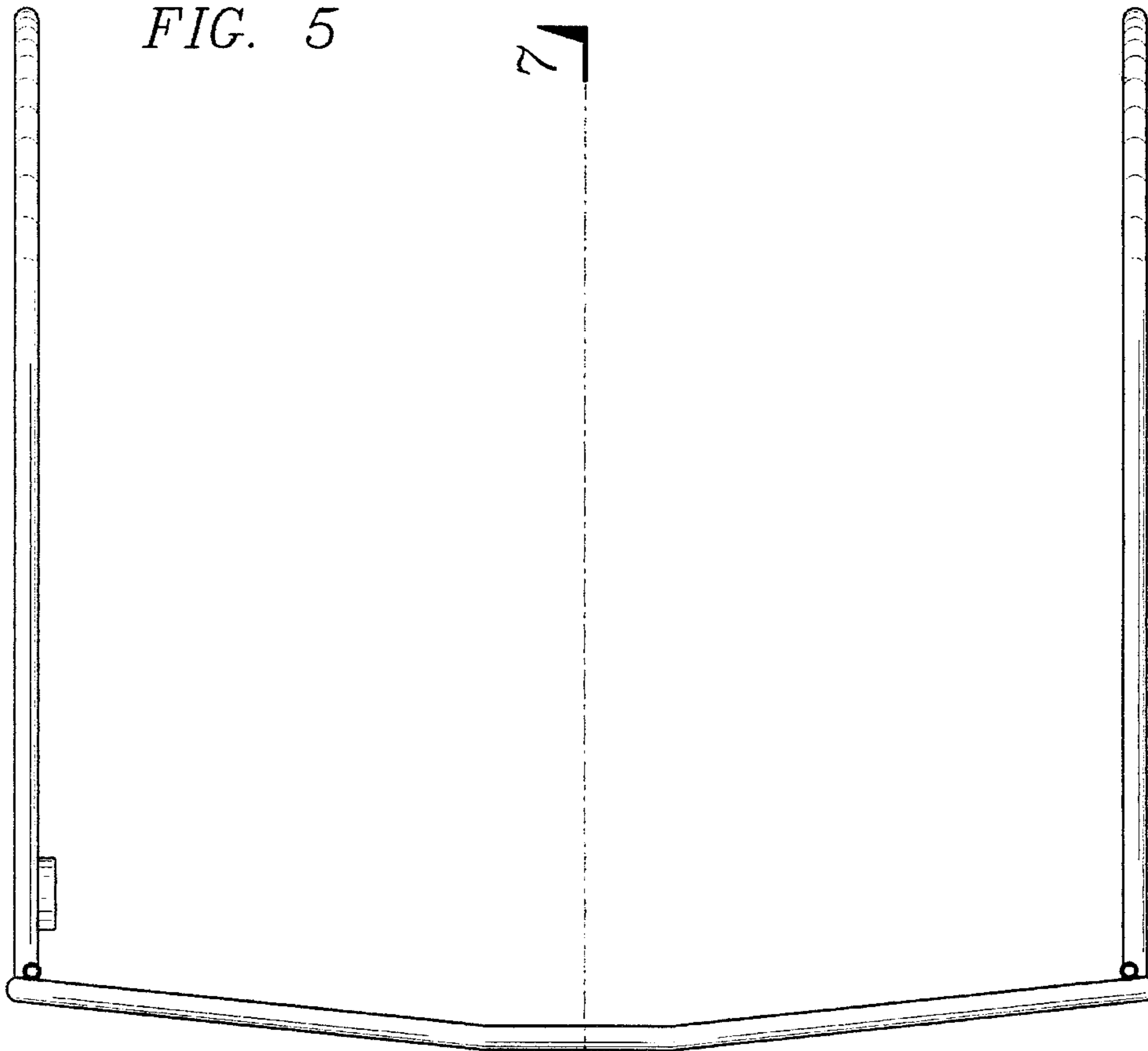

FIG. 6

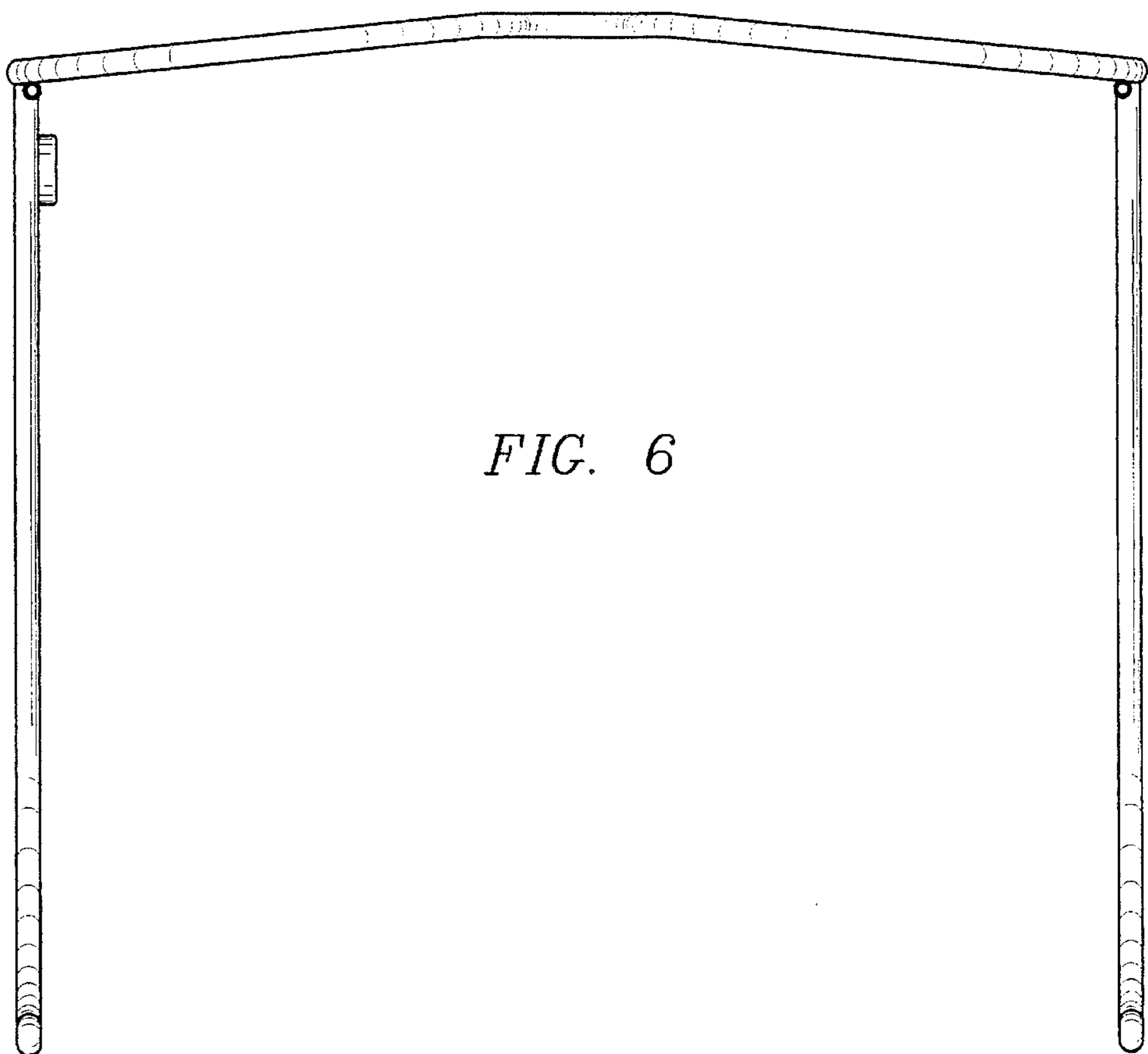

FIG. 7

