



US00D366809S

United States Patent [19] Green

[11] Patent Number: **Des. 366,809**

[45] Date of Patent: ****Feb. 6, 1996**

[54] **DRINKING CONTAINER**

[76] Inventor: **Richard D. Green**, 4086 Del Rey Ave.,
Marina Del Ray, Calif. 90292

[**] Term: **14 Years**

[21] Appl. No.: **30,055**

[22] Filed: **Oct. 21, 1994**

[52] U.S. Cl. **D7/510; D7/511; D7/532**

[58] Field of Search D7/619, 622, 507,
D7/509, 510, 511, 513, 512, 514, 515,
516, 523, 524, 531, 532, 533, 534, 535,
536; D9/500, 503, 504, 537-540; 220/713,
711; 215/387, 388, 389

4,852,762 8/1989 Chou-Sheng .
4,925,043 5/1990 Dinand .
4,982,854 1/1991 Ichimiya .
5,054,631 10/1991 Robbins, III .
5,085,330 2/1992 Paulin 215/387 X
5,188,283 2/1993 Gu .
5,203,468 4/1993 Hsu .
5,273,172 12/1993 Rossbach et al. .
5,326,006 7/1994 Giard, Jr. 215/387 X
5,356,313 10/1994 Peyton, Jr. D7/510
5,361,934 11/1994 Spence 215/388 X

Primary Examiner—Alan P. Douglas
Assistant Examiner—M. N. Pandozzi
Attorney, Agent, or Firm—Kelly, Bauersfeld & Lowry

[56] **References Cited**

U.S. PATENT DOCUMENTS

D. 195,376 6/1963 Curtis D7/536
D. 332,373 1/1993 Kahl D7/510
D. 339,068 9/1993 Bell et al. D9/538
D. 340,836 11/1993 Cautereels D7/511
D. 359,654 6/1995 Westgerdes D7/510 X
D. 360,338 7/1995 Westgerdes D7/510 X
D. 360,829 8/1995 Leeds D9/538 X
2,529,817 11/1950 Russell .
2,844,267 7/1958 Petriccione .
3,294,293 12/1966 Johns .
3,337,098 8/1967 Johns .
3,371,827 3/1968 Micallef .
4,448,316 5/1984 Hiroshige .
4,509,655 4/1985 Killmann .

[57] **CLAIM**

The ornamental design for a drinking container, as shown and described.

DESCRIPTION

FIG. 1 is a perspective view showing the front, right and top views of a drinking container embodying my new design; FIG. 2 is a left side elevational view thereof, the right side elevation being a mirror image of the left side as shown; FIG. 3 is a top plan view thereof; FIG. 4 is a bottom plan view thereof; FIG. 5 is a rear elevational view thereof; FIG. 6 is a front elevational view thereof; and, FIG. 7 is a perspective view similar to FIG. 1, illustrating a cap in an open position.

1 Claim, 3 Drawing Sheets

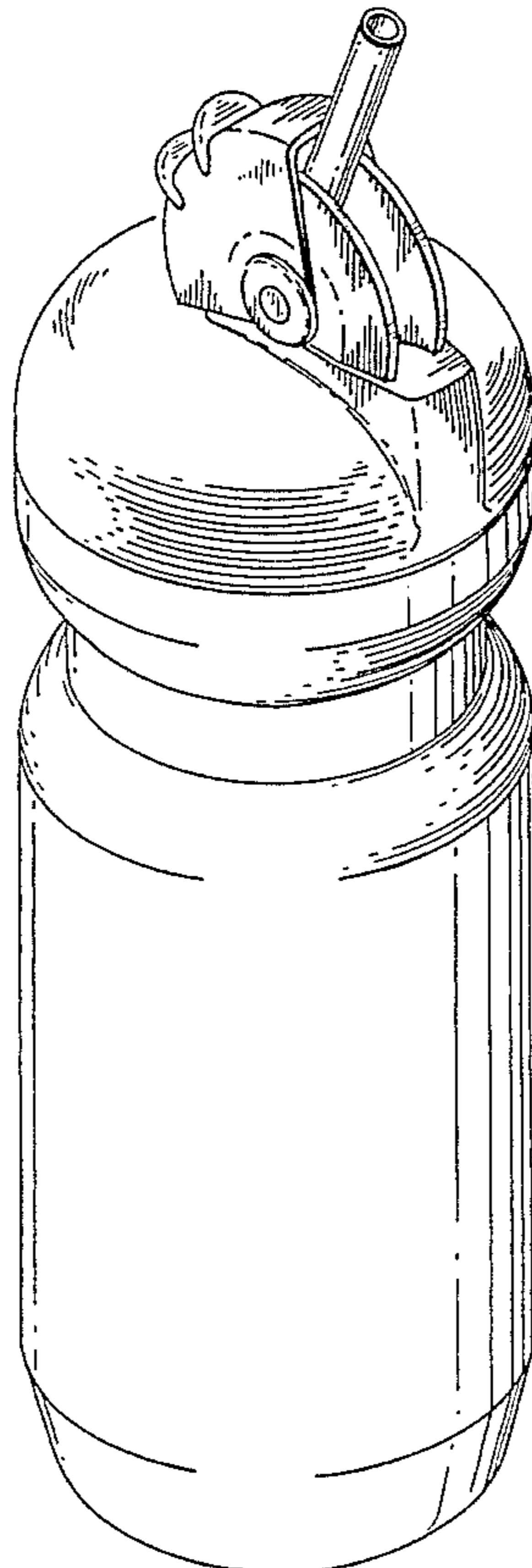

FIG. 1

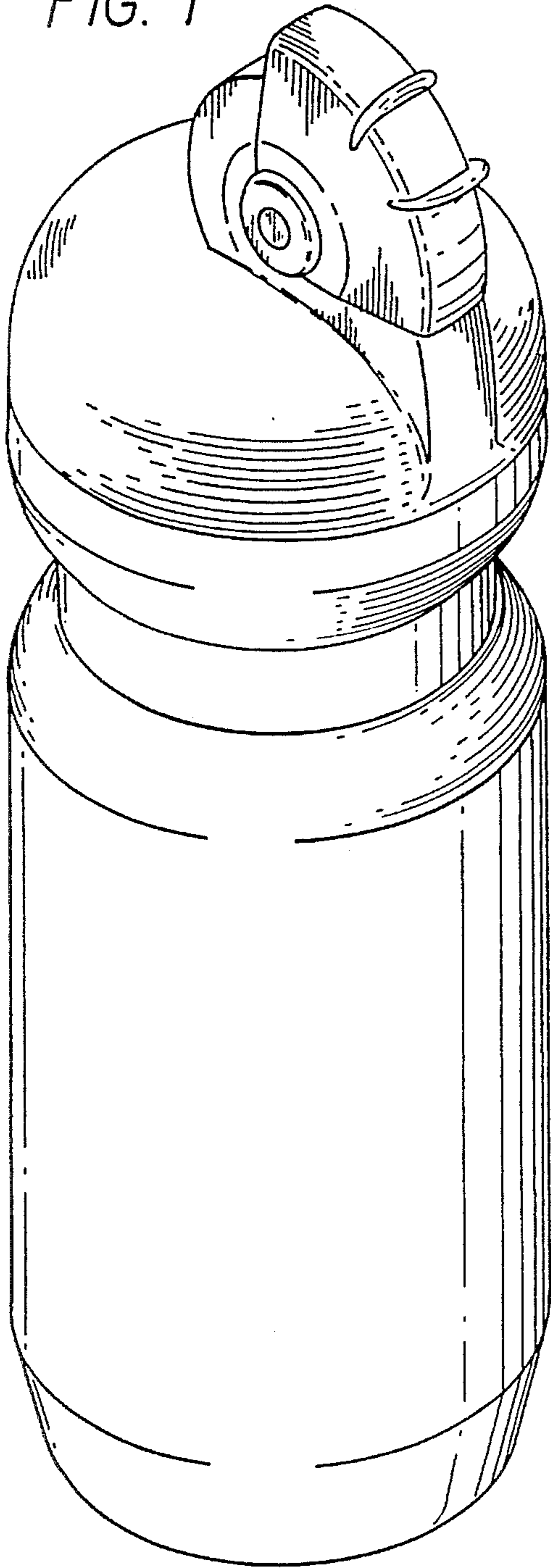

FIG. 7

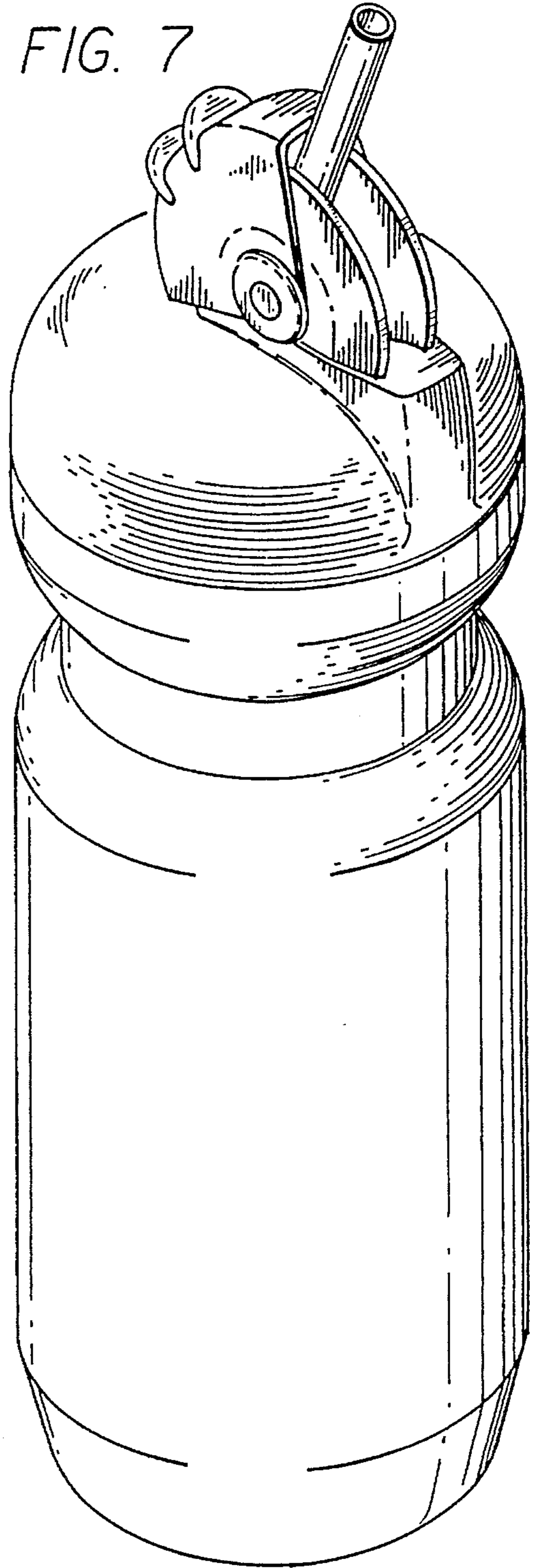

FIG. 2

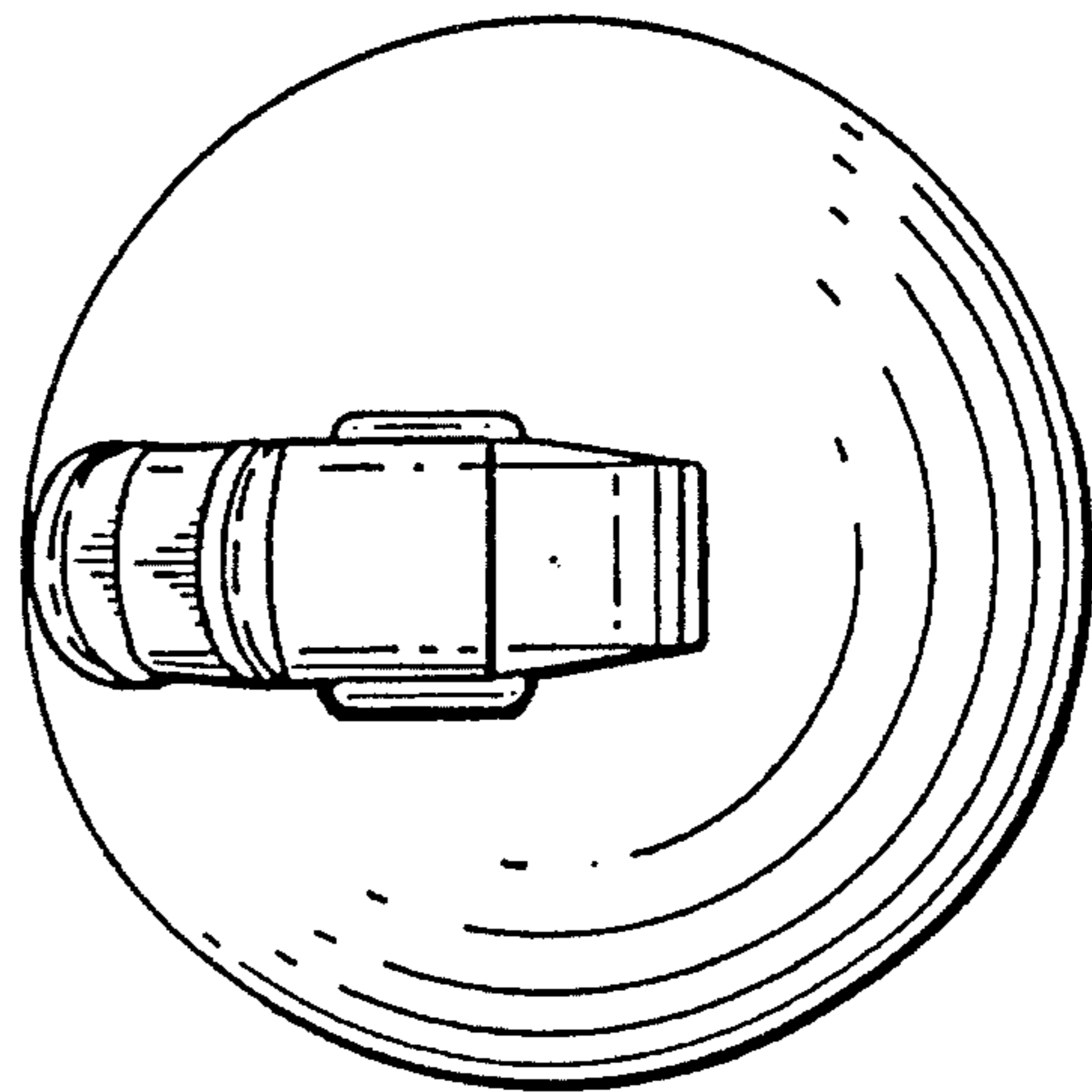
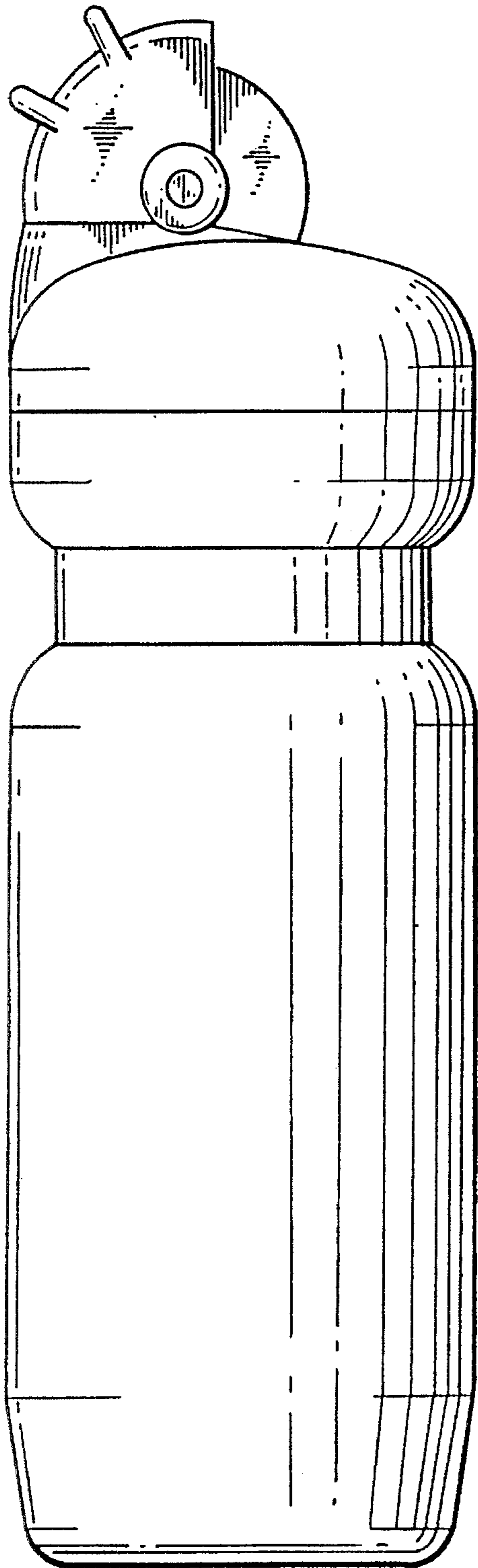

FIG. 3

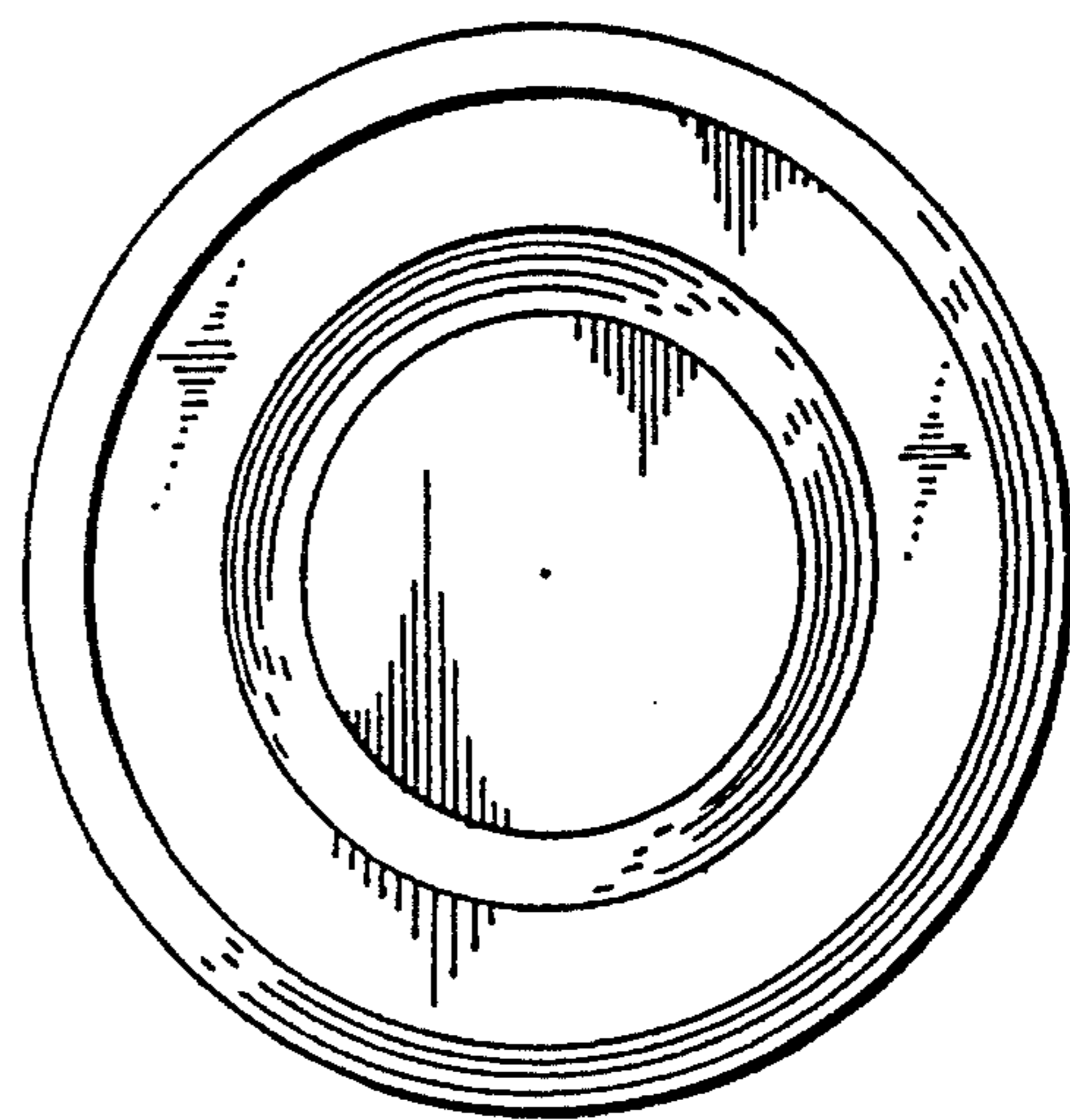

FIG. 4

FIG. 5

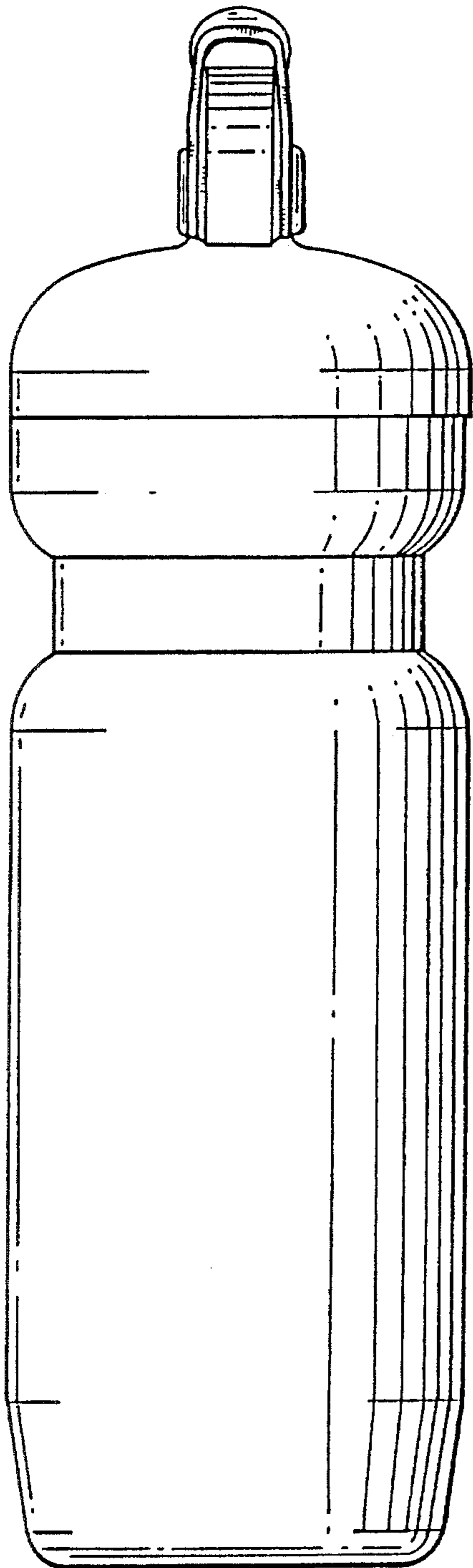
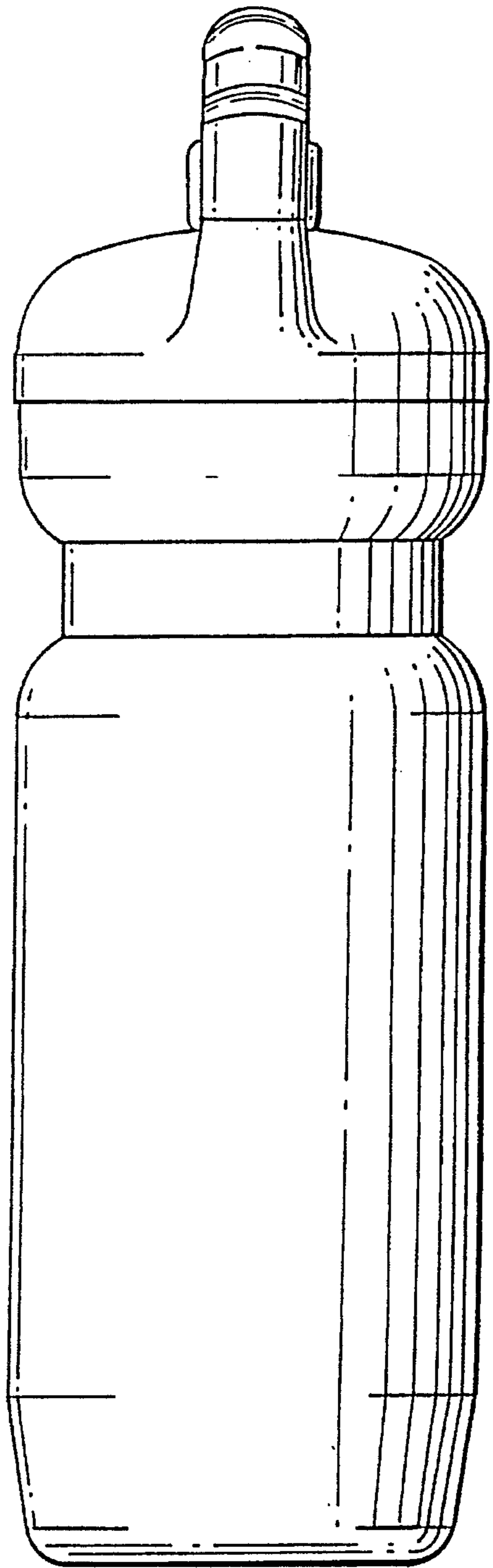

FIG. 6



UNITED STATES PATENT AND TRADEMARK OFFICE
CERTIFICATE OF CORRECTION

PATENT NO. : Des. 366,809
DATED : Feb. 6, 1996
INVENTOR(S) : Green, Richard D.

Page 1 of 5

It is certified that error appears in the above-identified patent and that said Letters Patent is hereby corrected as shown below:

The title page, showing an illustrative figure, should be deleted and substitute therefor the attached title page.

Delete Drawing Sheets 1 of 3, 2 of 3, and 3 of 3, and substitute therefor the Drawing Sheets, consisting of 1 of 3, 2 of 3, 3 of 3, as shown on the attached pages.

Signed and Sealed this
Twenty-first Day of May, 1996



Attest:

BRUCE LEHMAN

Attesting Officer

Commissioner of Patents and Trademarks

United States Patent (19)
Green

(11) **Patent Number:** Des. 366,809
(45) **Date of Patent:** **Feb. 6, 1996

[54] **DRINKING CONTAINER**
[76] **Inventor:** Richard D. Green, 4086 Del Rey Ave.,
Manna Del Ray, Calif. 90292
[**] **Term:** 14 Years
[21] **Appl. No.:** 30,055
[22] **Filed:** Oct. 21, 1994
[52] **U.S. Cl.:** D7/510; D7/511; D7/532
[58] **Field of Search:** D7/619, 622, 507,
D7/509, 510, 511, 513, 512, 514, 515,
516, 523, 524, 531, 532, 533, 534, 535,
536; D9/500, 503, 504, 537-540; 220/713,
711; 215/387, 388, 389

| | | | |
|-----------|---------|-------------------|-----------|
| 4,852,762 | 8/1989 | Chou-Sheng . | |
| 4,925,043 | 5/1990 | Dinand . | |
| 4,982,854 | 1/1991 | Ichimura . | |
| 5,054,631 | 10/1991 | Robbins, III . | |
| 5,085,330 | 2/1992 | Paulin | 215/387 X |
| 5,188,283 | 2/1993 | Gu . | |
| 5,203,468 | 4/1993 | Hsu . | |
| 5,273,172 | 12/1993 | Rossbach et al. . | |
| 5,326,006 | 7/1994 | Giard, Jr. | 215/387 X |
| 5,356,313 | 10/1994 | Peyton, Jr. | D7/510 |
| 5,361,934 | 11/1994 | Spence | 215/388 X |

Primary Examiner—Alan P. Douglas
Assistant Examiner—M. N. Pandozzi
Attorney Agent, or Firm—Kelly, Bauersfeld & Lowry

[57] **CLAIM**

The ornamental design for a drinking container, as shown and described.

[56] **References Cited**

U.S. PATENT DOCUMENTS

| | | | |
|------------|---------|------------------|----------|
| D. 195,376 | 6/1963 | Curtis | D7/536 |
| D. 332,373 | 1/1993 | Kahl | D7/510 |
| D. 339,068 | 9/1993 | Bell et al. | D9/538 |
| D. 340,836 | 11/1993 | Cautereels | D7/511 |
| D. 359,654 | 6/1995 | Westgerdes | D7/510 X |
| D. 360,338 | 7/1995 | Westgerdes | D7/510 X |
| D. 360,829 | 8/1995 | Leeds | D9/538 X |
| 2,529,817 | 11/1950 | Russell . | |
| 2,844,267 | 7/1958 | Petriccione . | |
| 3,294,293 | 12/1966 | Johns . | |
| 3,337,098 | 8/1967 | Johns . | |
| 3,371,827 | 3/1968 | Micallef . | |
| 4,448,316 | 5/1984 | Hiroshige | |
| 4,509,655 | 4/1985 | Killmann . | |

DESCRIPTION

FIG. 1 is a perspective view showing the front, right and top views of a drinking container embodying my new design; FIG. 2 is a left side elevational view thereof, the right side elevation being a mirror image of the left side as shown; FIG. 3 is a top plan view thereof; FIG. 4 is a bottom plan view thereof; FIG. 5 is a rear elevational view thereof; FIG. 6 is a front elevational view thereof; and, FIG. 7 is a perspective view similar to FIG. 1, illustrating a cap in an open position.

1 Claim, 3 Drawing Sheets

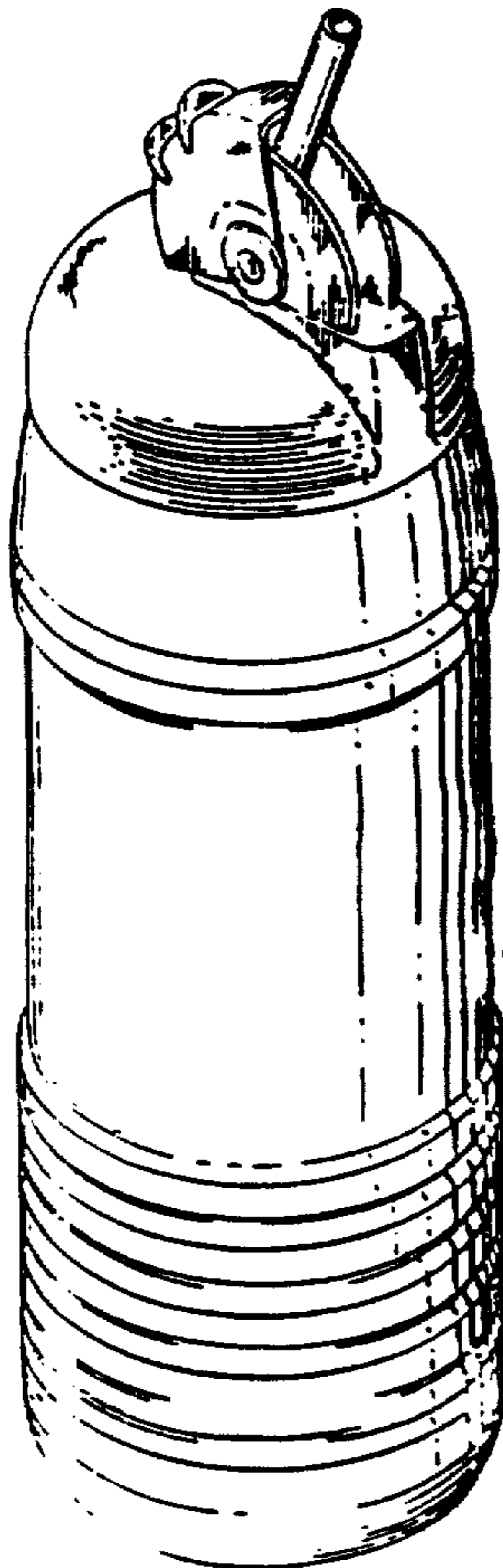

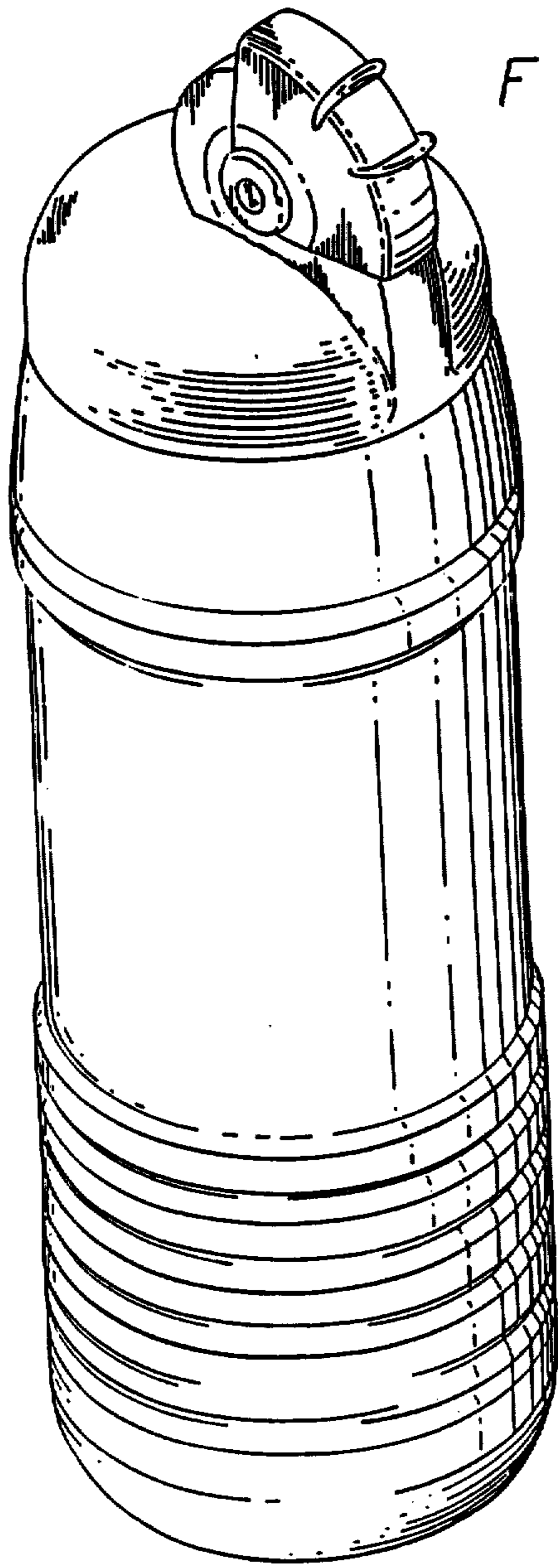

FIG. 1

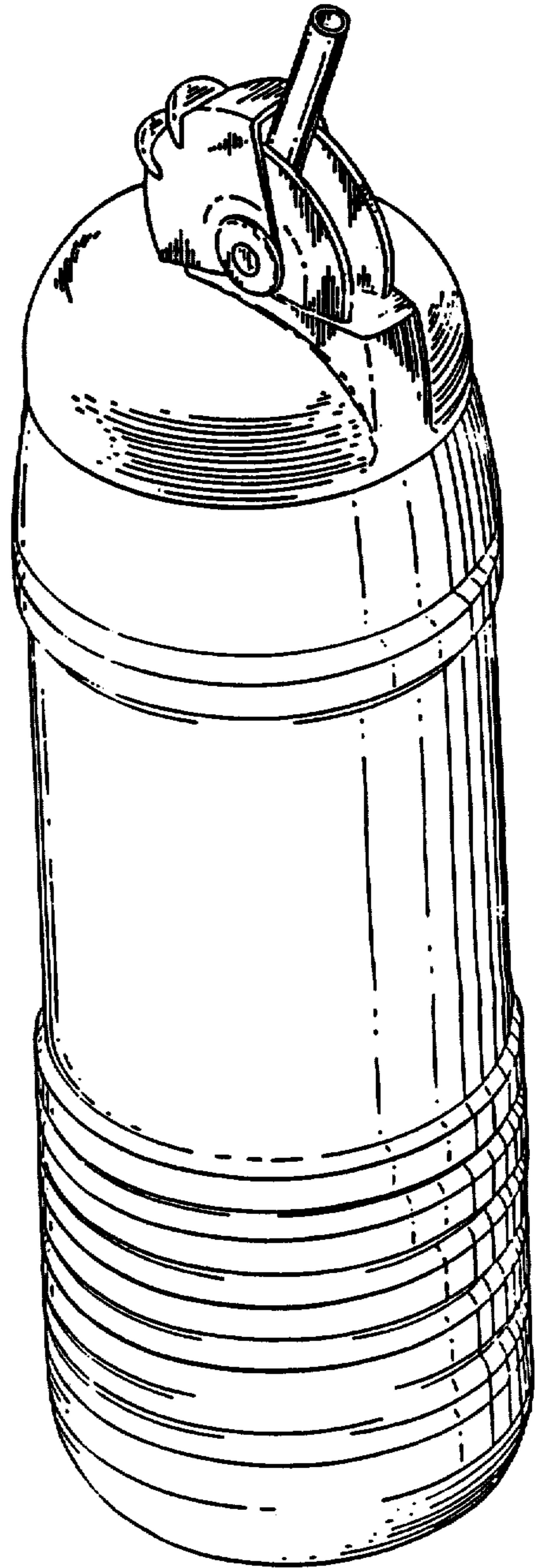

FIG. 7

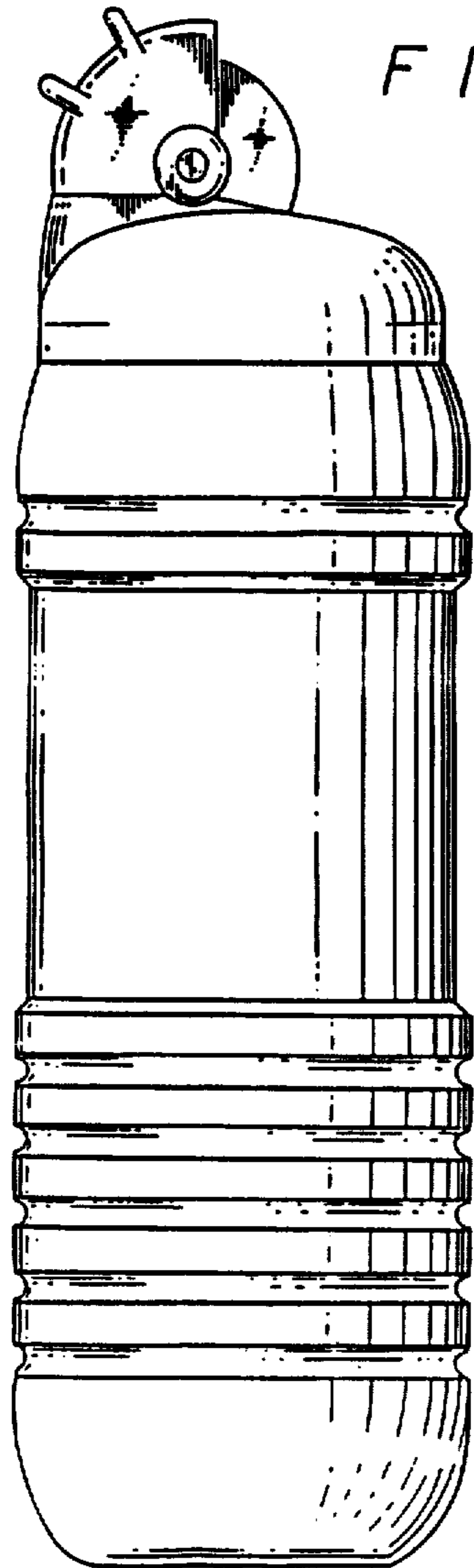

FIG. 2

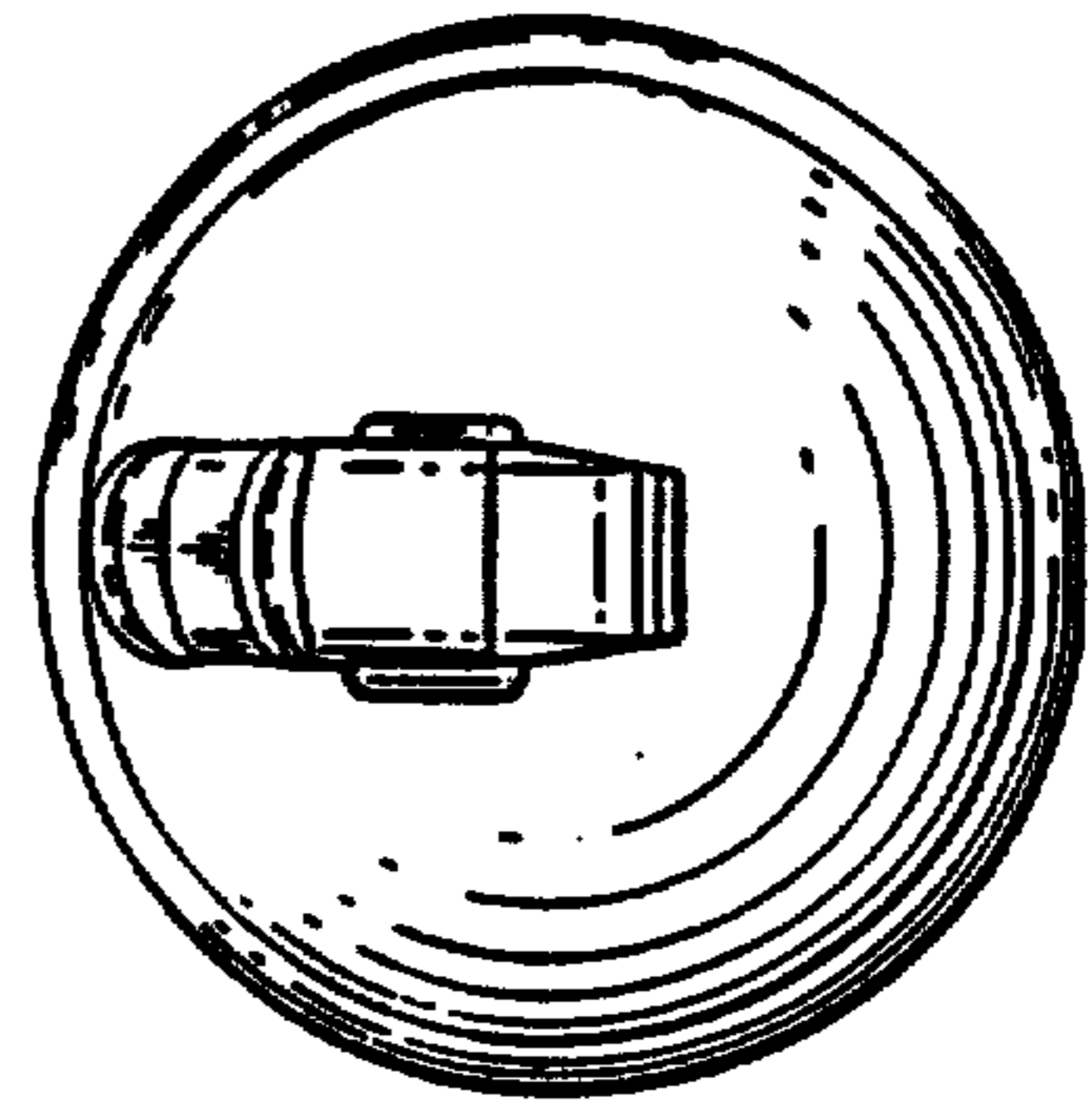

FIG. 3

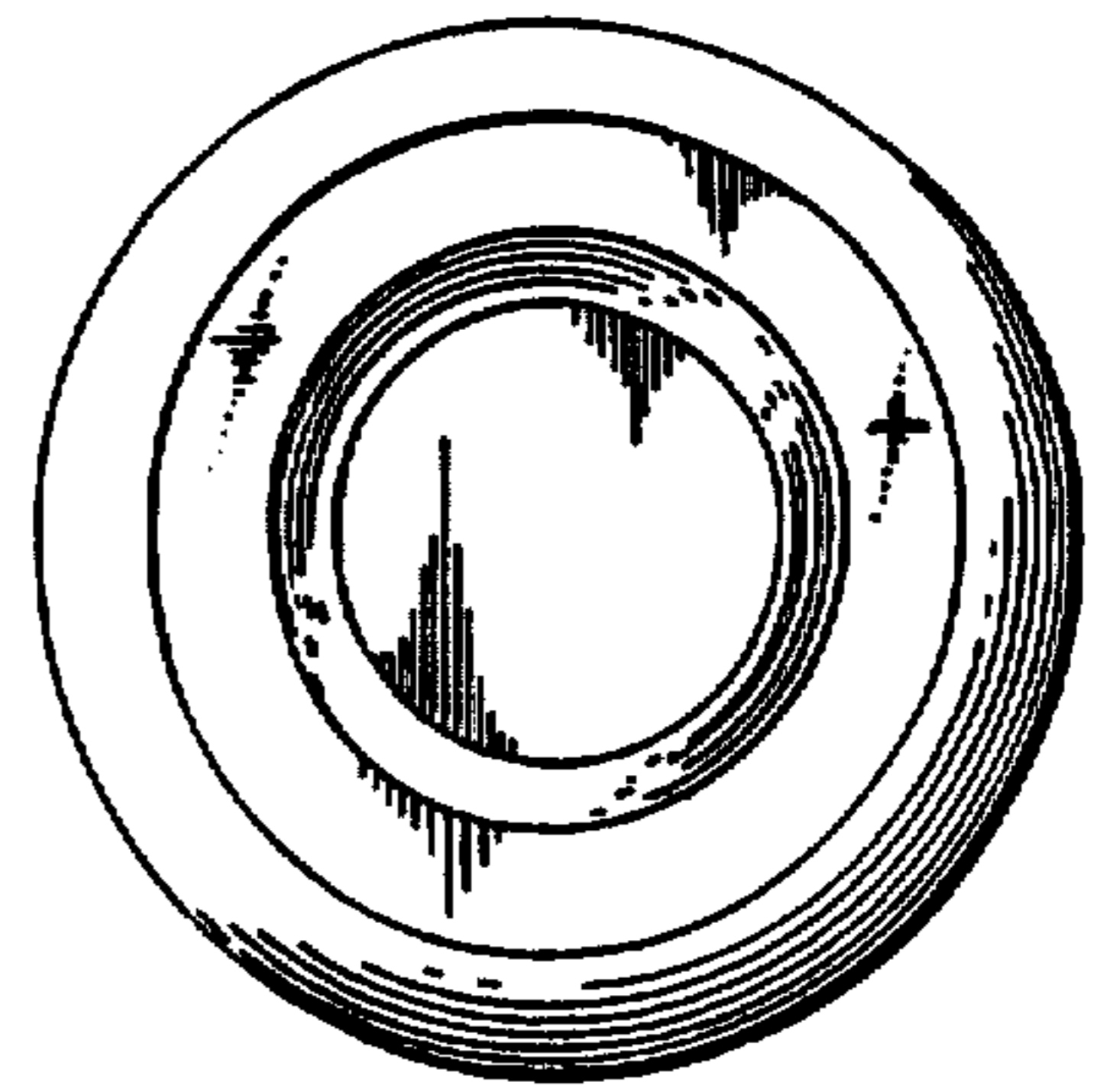

FIG. 4

FIG. 5

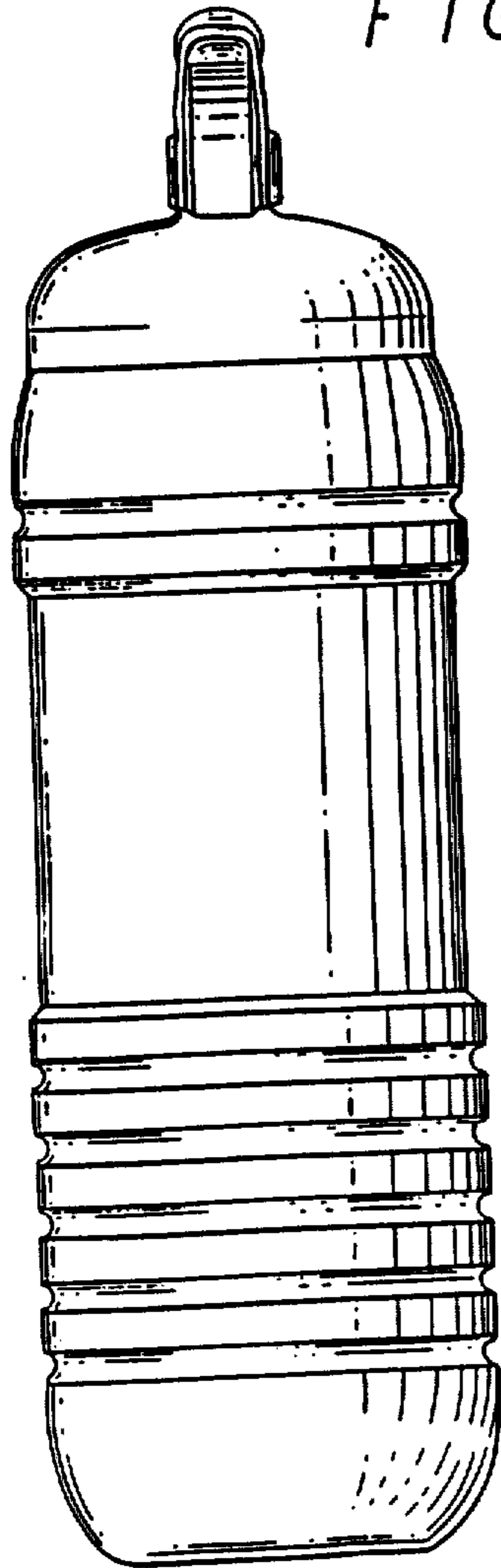

FIG. 6

