



US00D366775S

# United States Patent [19] Kane

[11] Patent Number: **Des. 366,775**

[45] Date of Patent: **\*\*Feb. 6, 1996**

[54] BENCH

D. 361,442 8/1995 Lewis ..... D6/381

[75] Inventor: **Brian J. Kane**, San Francisco, Calif.

### OTHER PUBLICATIONS

Willow & Reed, ©1970, p. 27, sofa #494 shown.

[73] Assignee: **Landscape Forms, Inc.**, Kalamazoo, Mich.

*Primary Examiner*—Gary D. Watson  
*Attorney, Agent, or Firm*—Heslin & Rothenberg

[\*\*] Term: **14 Years**

### [57] CLAIM

[21] Appl. No.: **38,538**

The ornamental design for a bench, as shown and described.

[22] Filed: **May 8, 1995**

### DESCRIPTION

[52] U.S. Cl. .... **D6/370; D6/376; D6/381**

[58] Field of Search ..... D6/334, 335, 369,  
D6/370, 371, 373, 374, 375, 376, 381,  
500, 501, 502; 297/232

FIG. 1 is a front side isometric view of a bench, showing my new design;

FIG. 2 is a top plan view thereof;

FIG. 3 is a front elevational view thereof;

FIG. 4 is a bottom plan view thereof;

FIG. 5 is a back elevational view thereof;

FIG. 6 is a right side elevational view thereof; and,

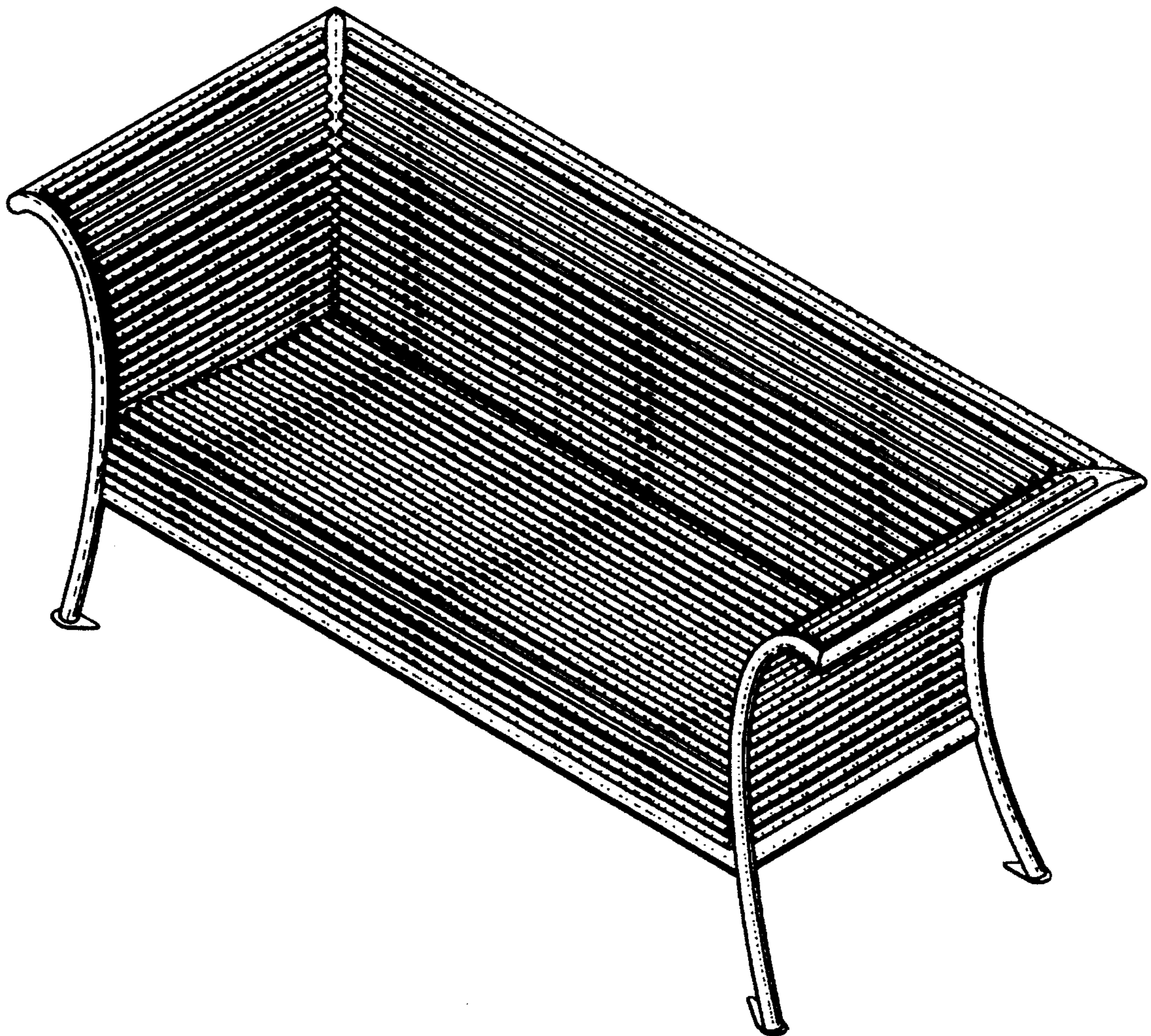
FIG. 7 is a left side elevational view thereof.

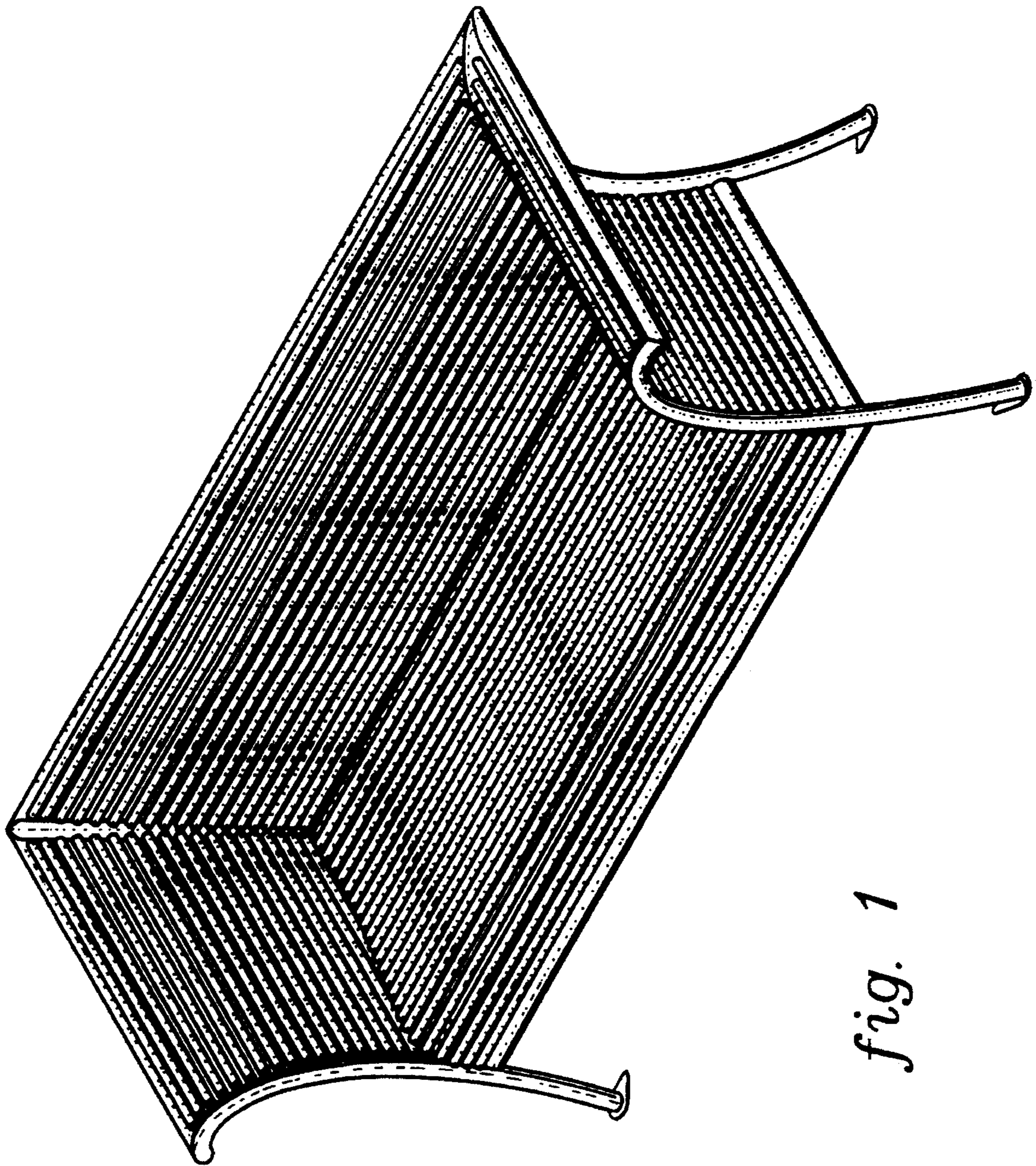
### [56] References Cited

#### U.S. PATENT DOCUMENTS

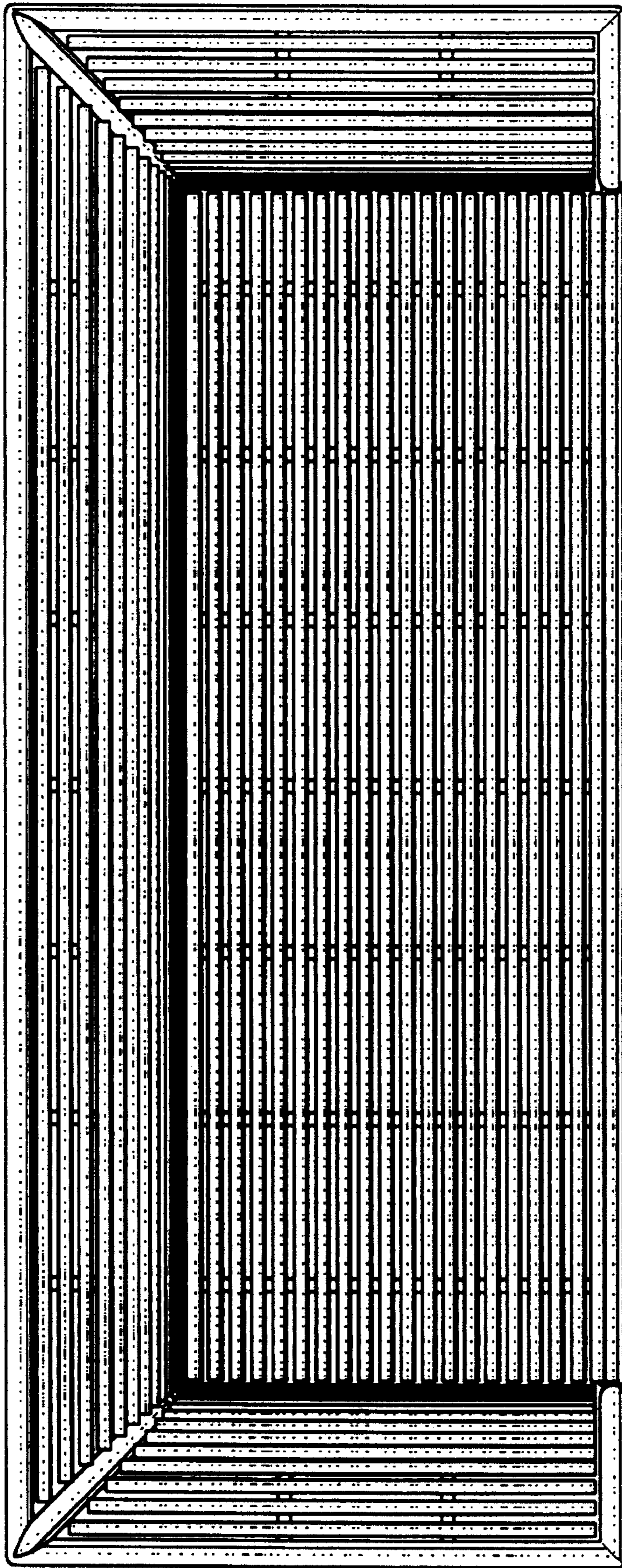
D. 101,273 9/1936 Ferguson ..... D6/370  
D. 229,591 12/1973 Trail et al. .... D6/370  
D. 360,538 7/1995 Skalka ..... D6/370

**1 Claim, 6 Drawing Sheets**

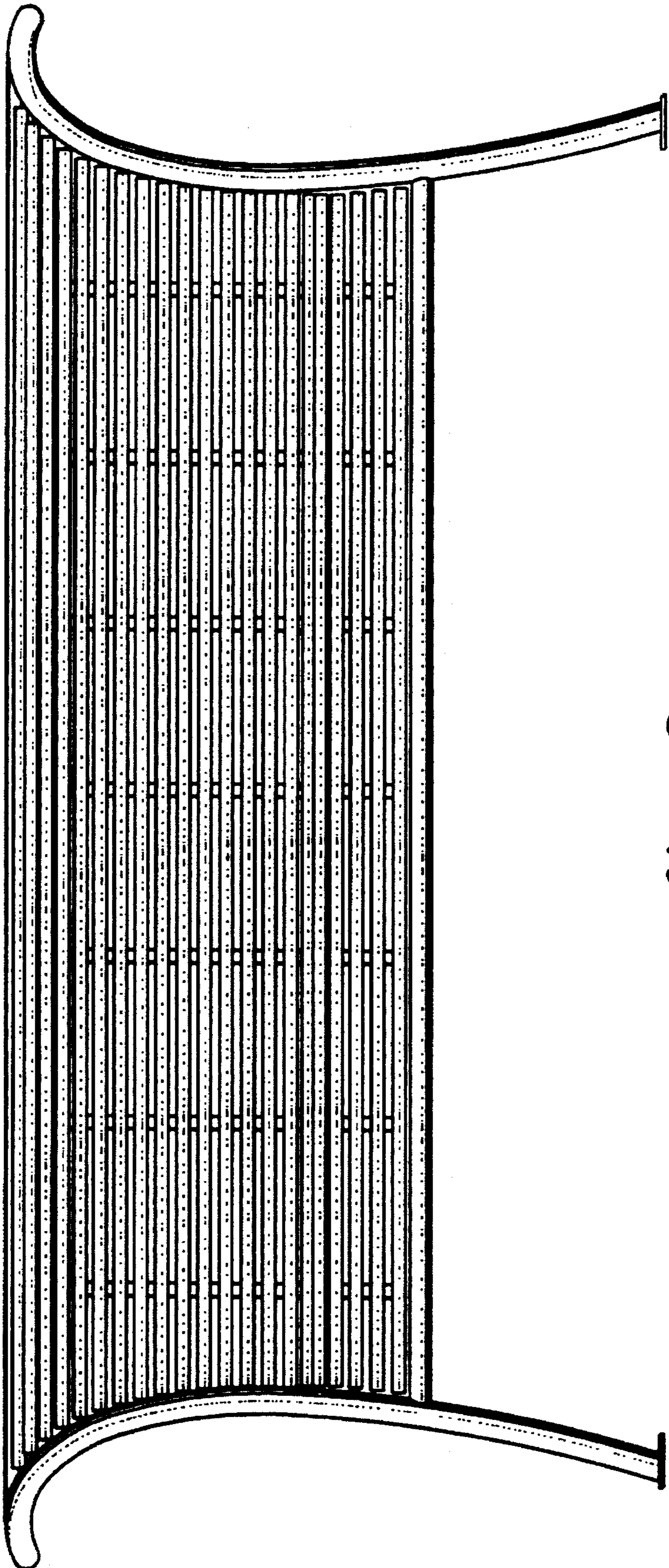




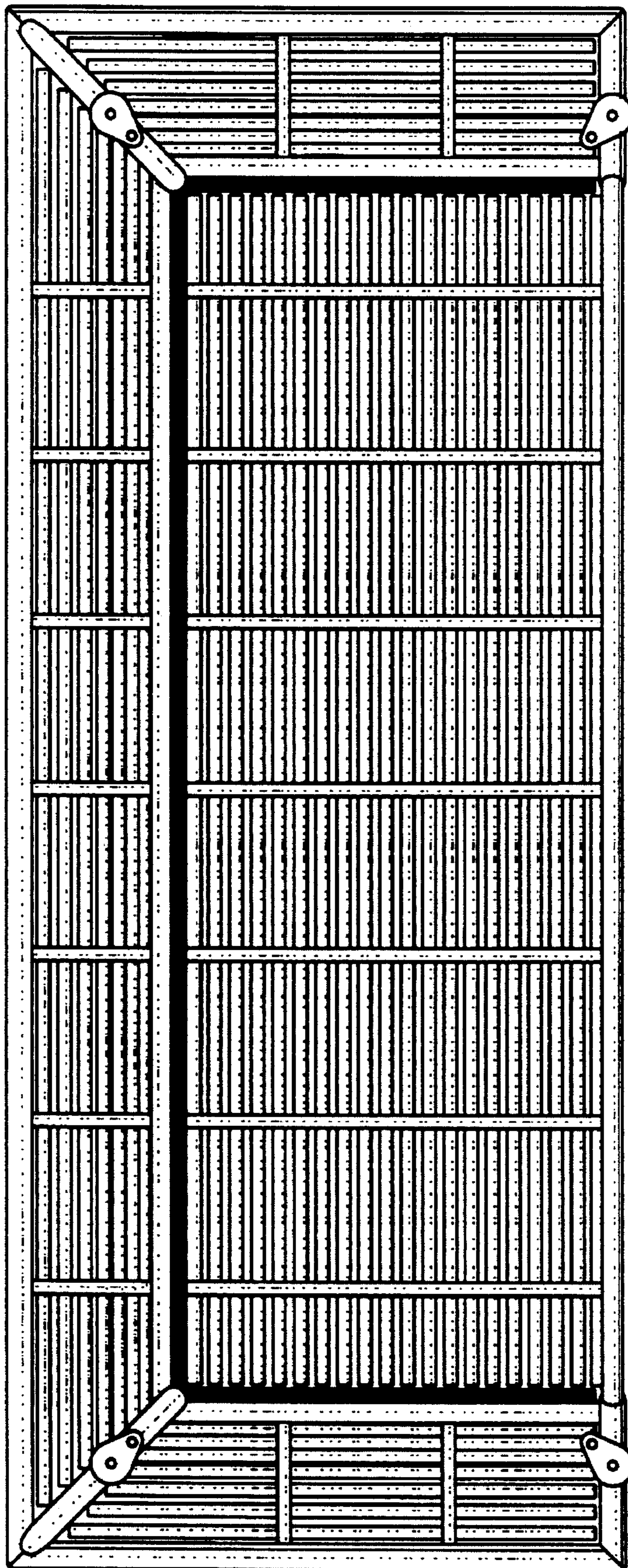
*fig. 1*



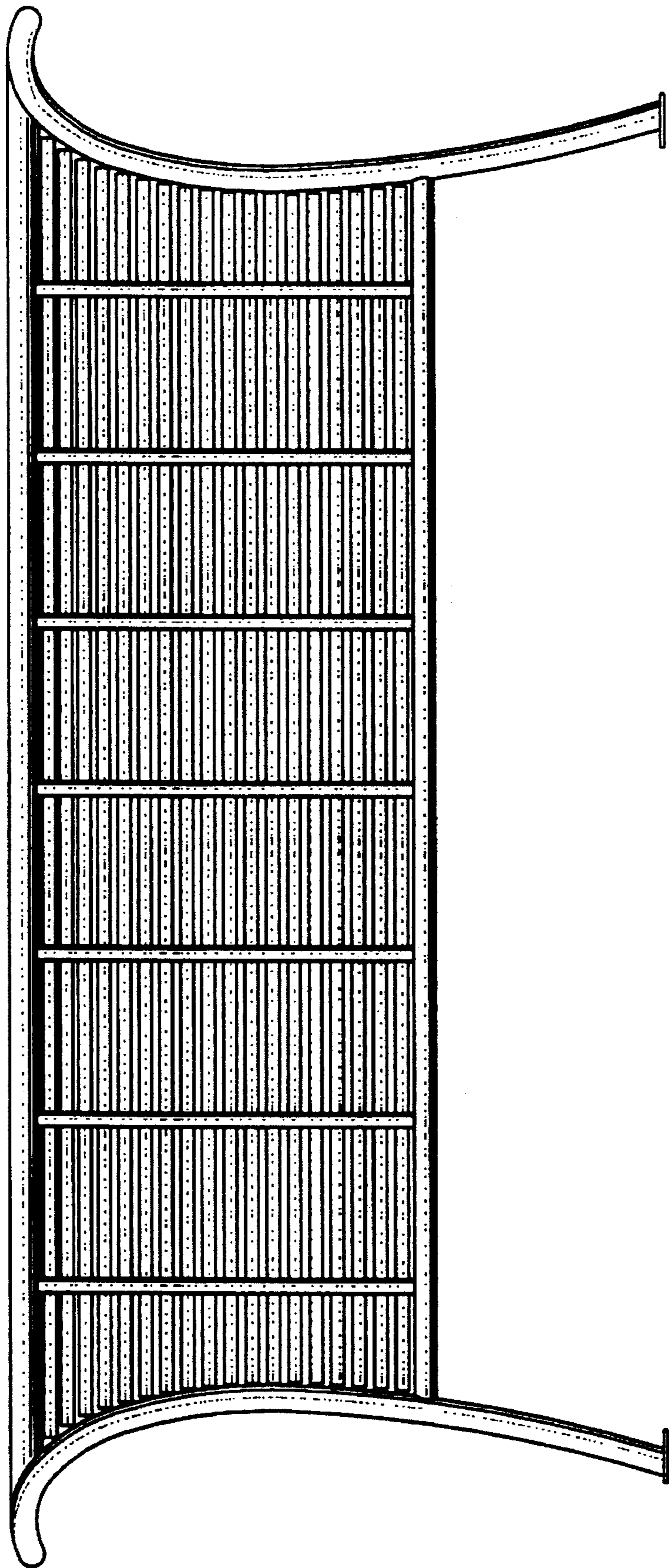
*fig. 2*



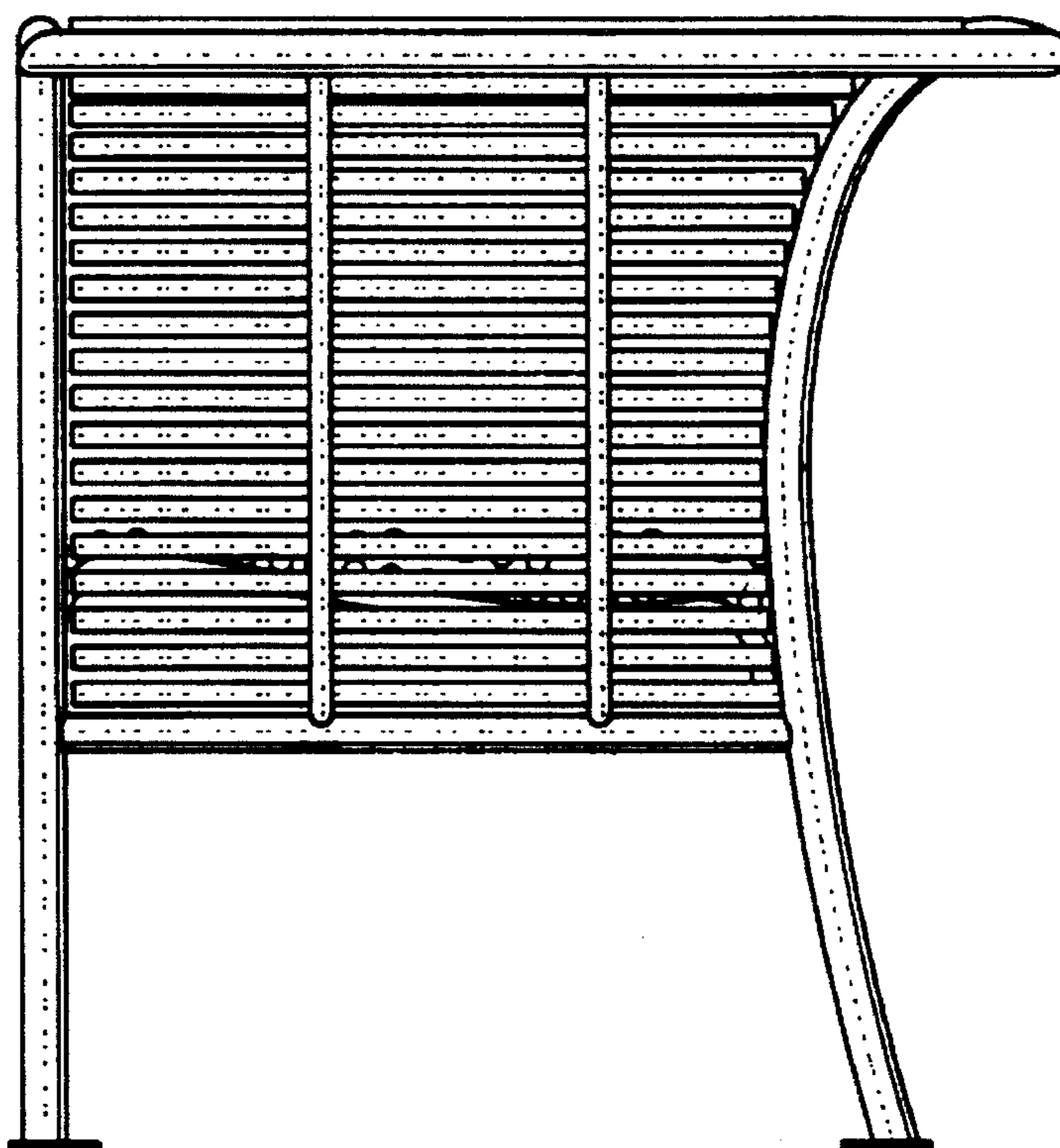
*fig. 3*



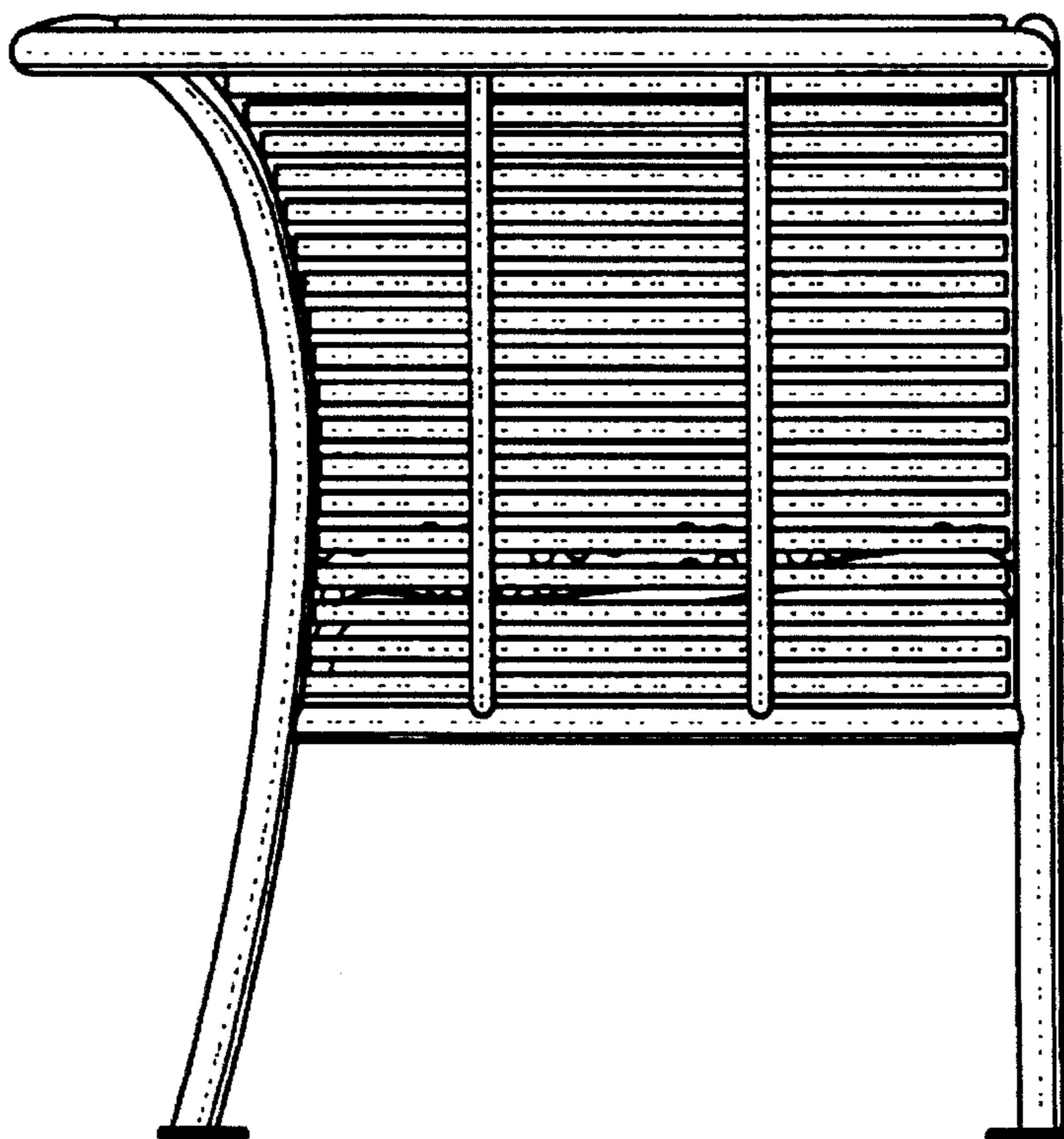
*fig. 4*



*fig. 5*



*fig. 6*



*fig. 7*