



US00D366737S

# United States Patent [19] Chen

[11] Patent Number: **Des. 366,737**  
[45] Date of Patent: **\*\*Jan. 30, 1996**

[54] **COMPACT DISC CLEANER**

4,783,870 11/1988 Yeung ..... 369/72 X  
5,334,254 8/1994 Gelardi et al. .... 369/72 X

[76] Inventor: **Yong E. Chen**, Rm. C, 12th Fl., Fu Hsing North Rd., Taipei, Taiwan

[\*\*] Term: **14 Years**

*Primary Examiner*—A. Hugo Word  
*Assistant Examiner*—Cynthia E. Ramirez  
*Attorney, Agent, or Firm*—Bacon & Thomas

[21] Appl. No.: **26,033**

[57] **CLAIM**

[22] Filed: **Jul. 18, 1994**

The ornamental design for a compact disc cleaner, as shown and described.

[52] U.S. Cl. .... **D32/35; D28/78; D9/428**

[58] Field of Search ..... D28/78, 76, 82, D28/91; D9/420, 423, 424, 426, 428, 539; D32/35; D24/101; 206/528; 369/72

**DESCRIPTION**

[56] **References Cited**

**U.S. PATENT DOCUMENTS**

D. 139,277	5/1944	Canterbury et al. ....	D28/82
D. 141,860	2/1945	Witt .....	D28/82
D. 249,332	9/1978	Hauf .....	D9/420
D. 254,703	4/1980	Seres .....	D32/40
D. 258,575	3/1981	Stettler .....	D9/420
2,549,681	4/1951	Goldstaub .....	206/528
4,556,433	12/1985	Clausen .....	369/72 X
4,641,391	2/1987	Debrey .....	15/104.94
4,654,917	4/1987	Yeung .....	15/97

FIG. 1 is a top perspective view of a compact disc cleaner showing my design, in which a cover of said compact disc cleaner is opened;  
FIG. 2 is a top perspective view thereof with said cover being closed;  
FIG. 3 is a front elevational view thereof;  
FIG. 4 is a rear elevational view thereof;  
FIG. 5 is a top plan view thereof;  
FIG. 6 is a bottom plan view thereof;  
FIG. 7 is a left side elevational view thereof; and,  
FIG. 8 is a right side elevational view thereof.

**1 Claim, 3 Drawing Sheets**

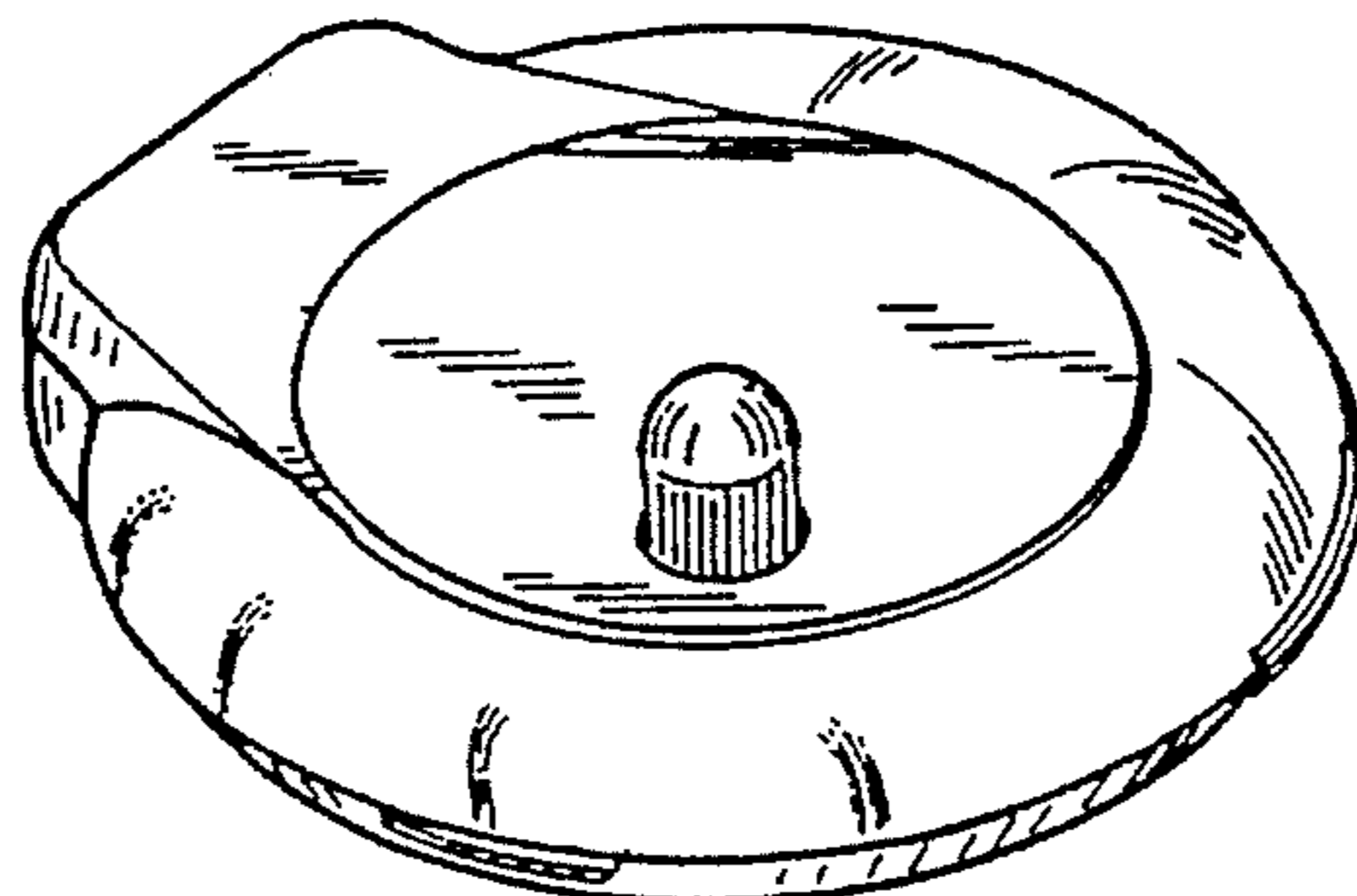
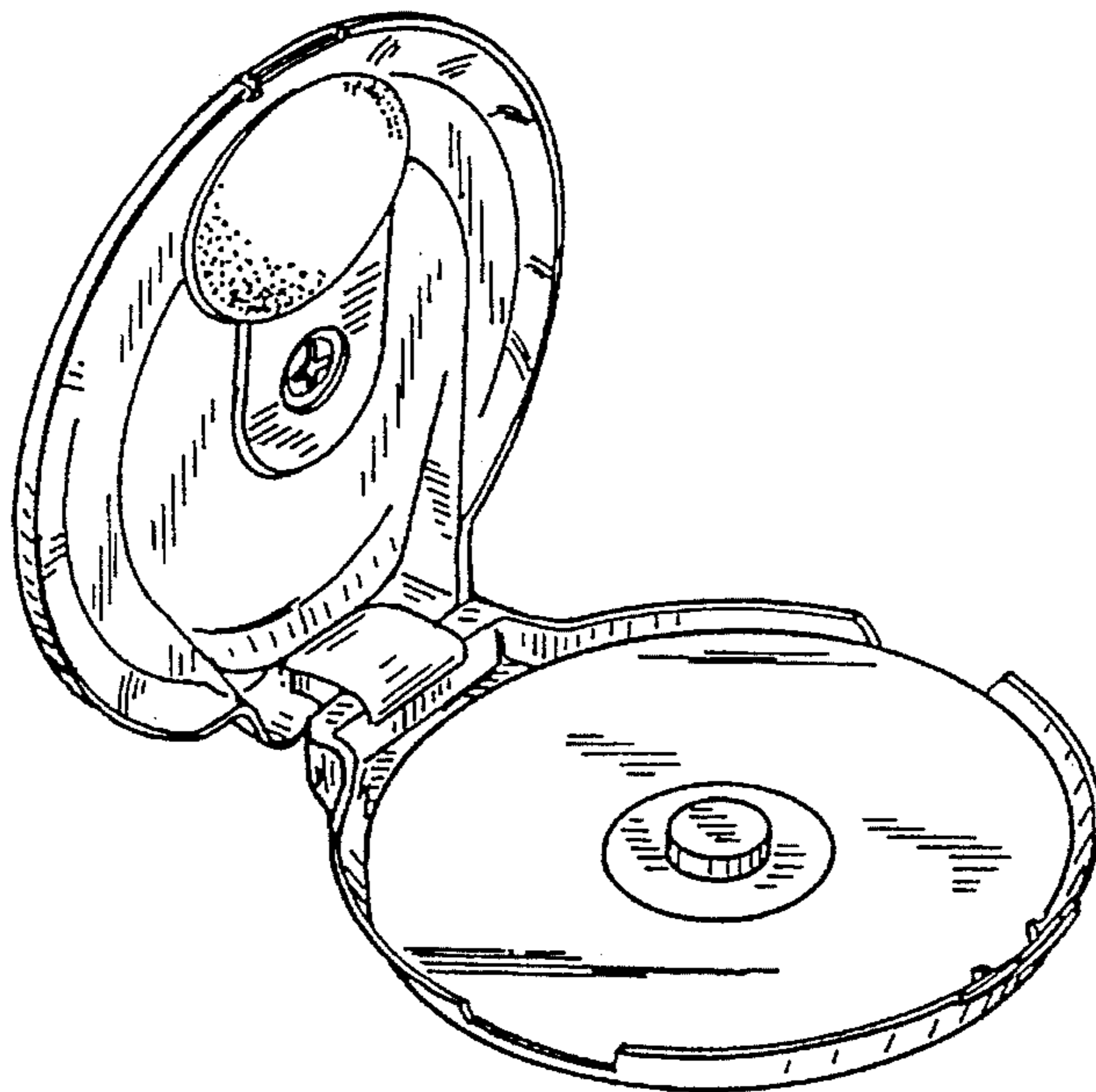

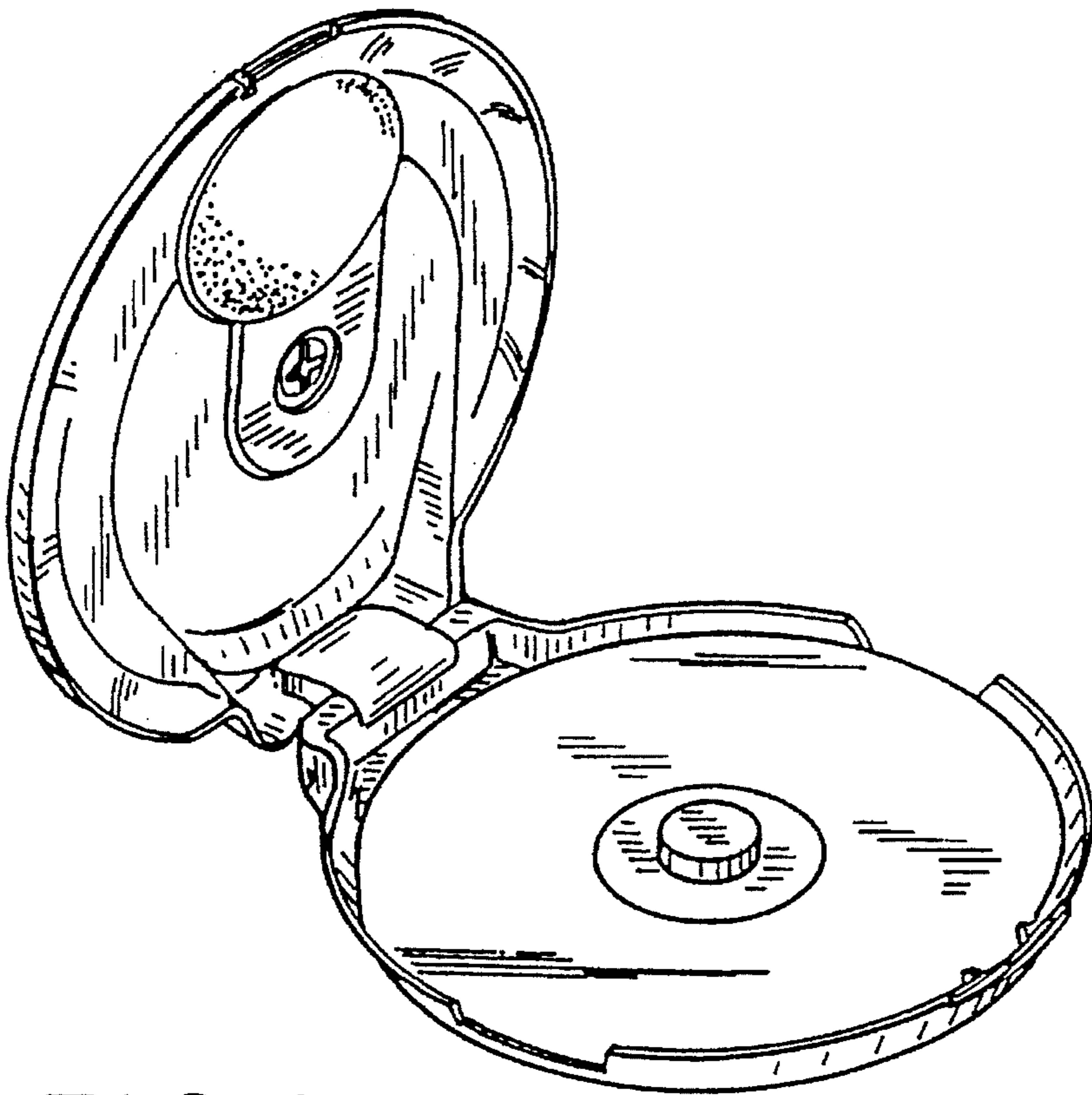

*FIG. 1*

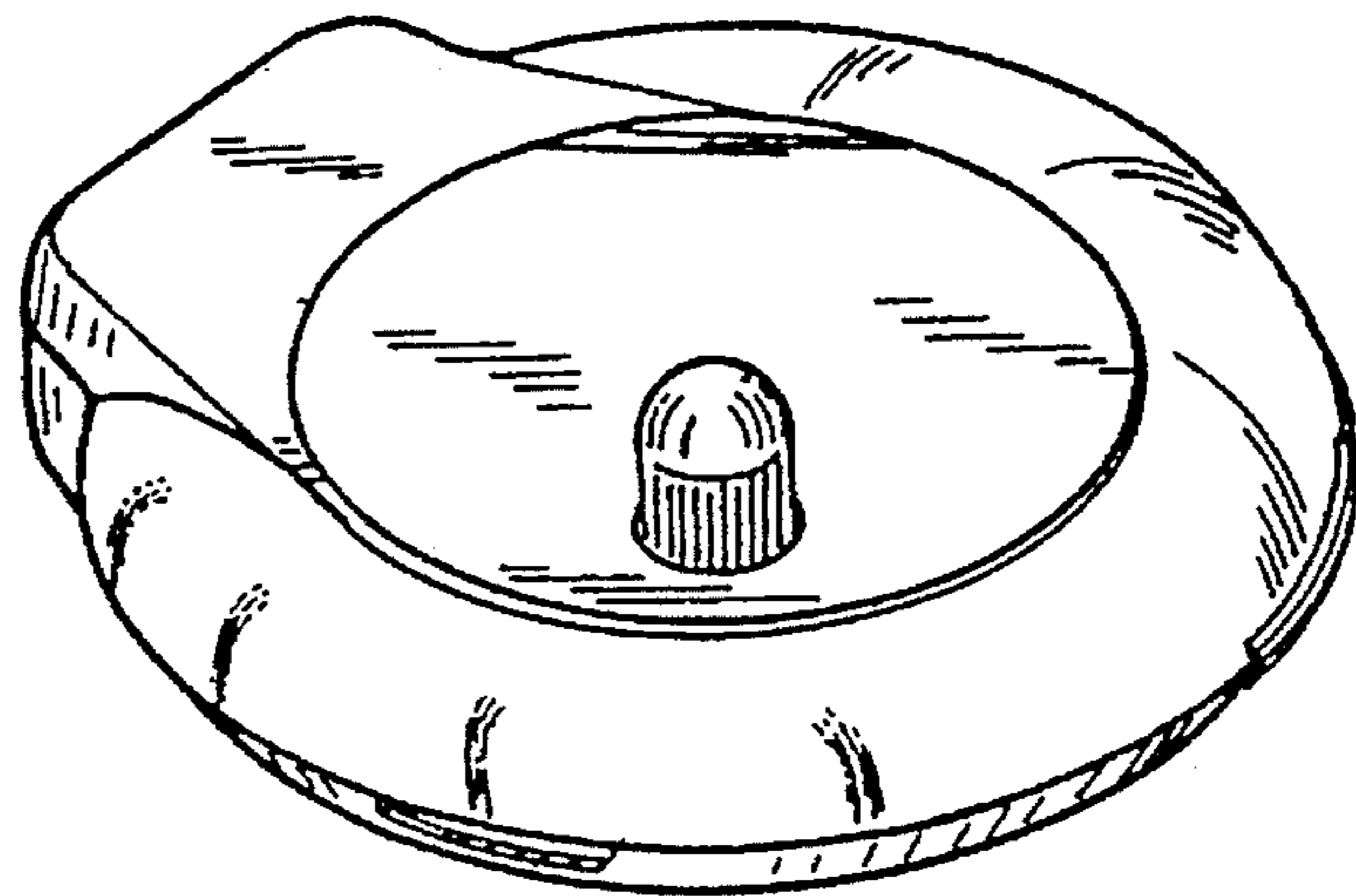

*FIG. 2*

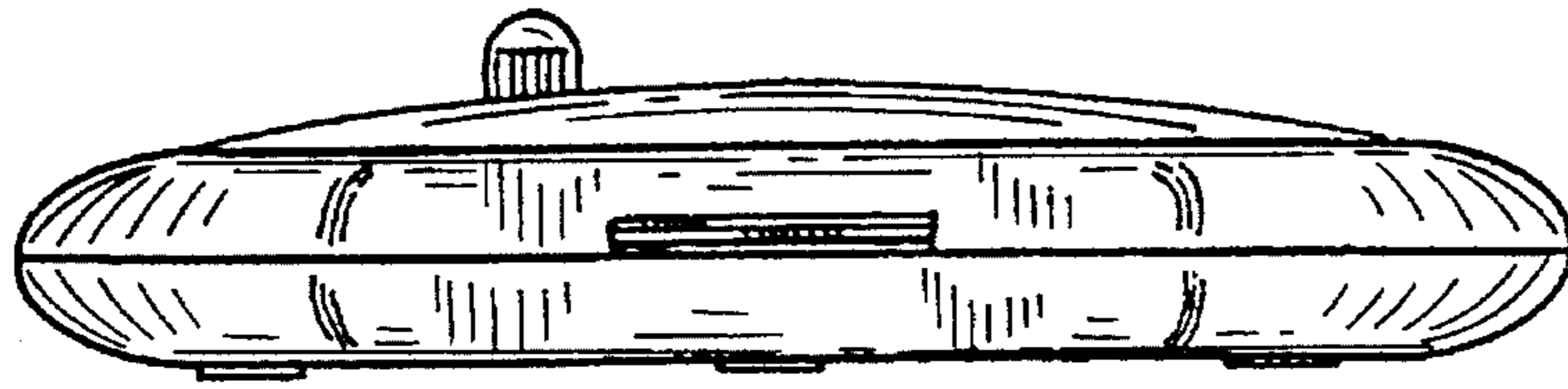

FIG. 3

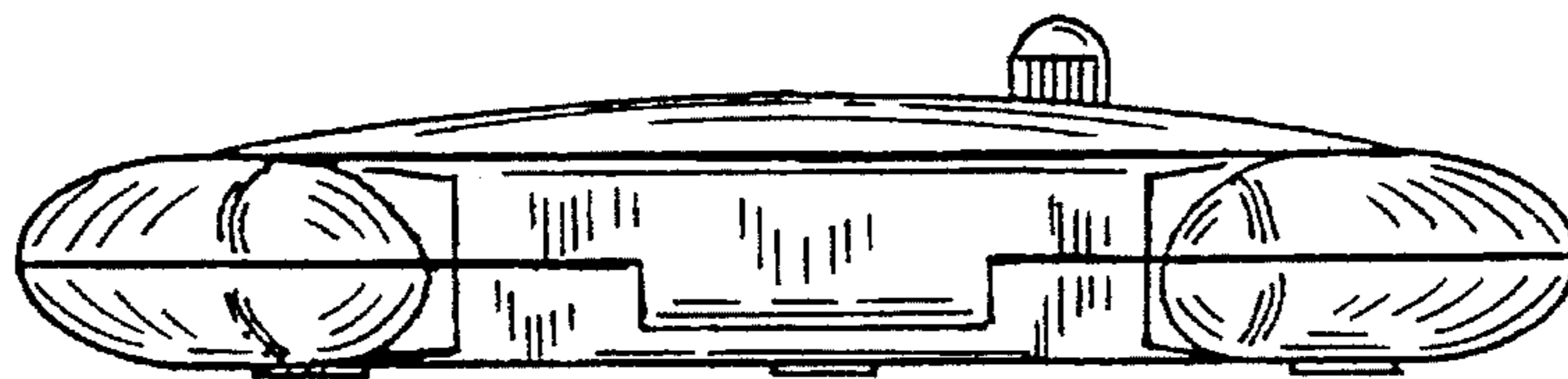

FIG. 4

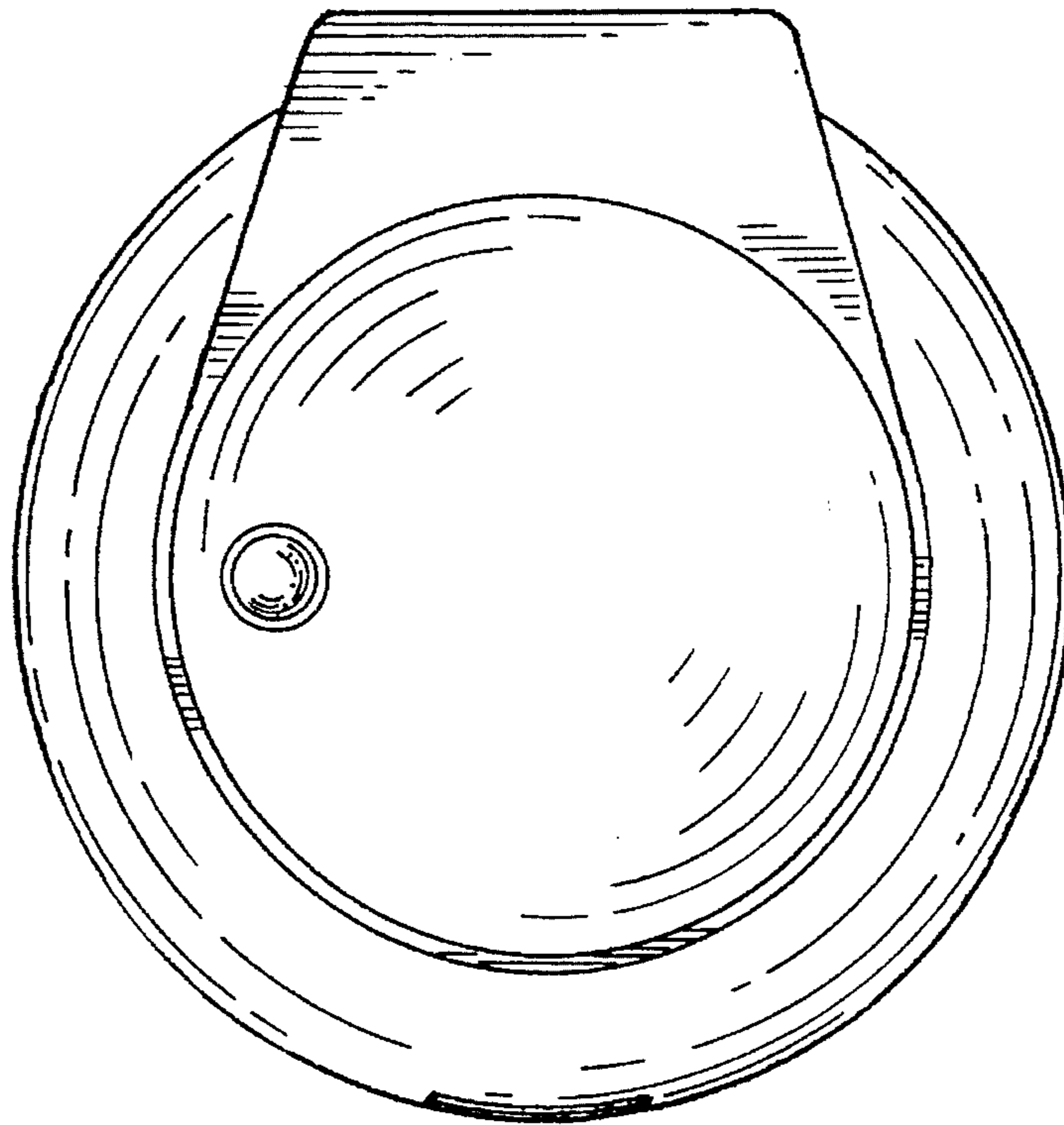

FIG. 5

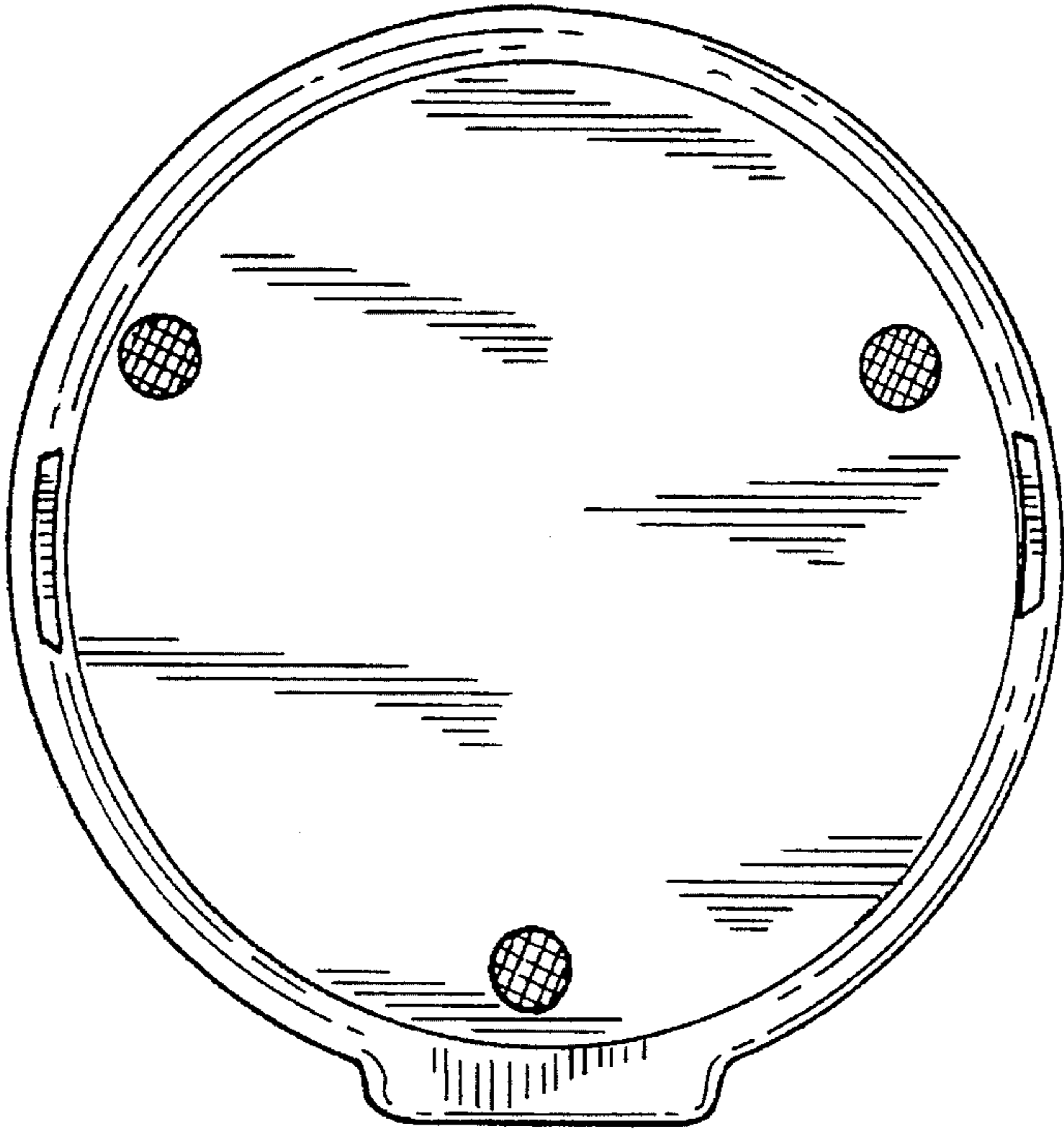

FIG. 6

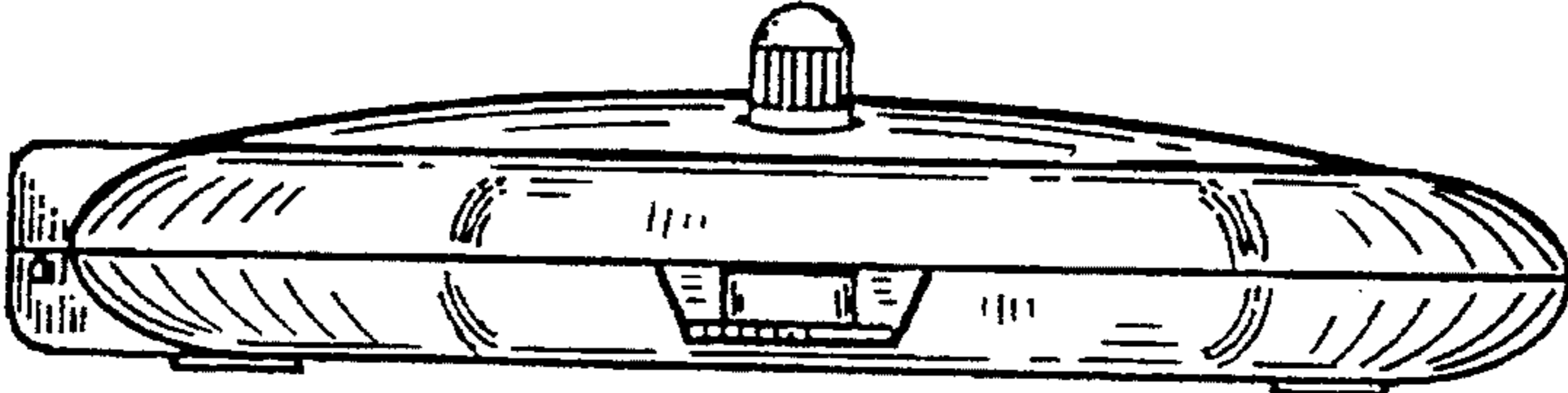

FIG. 7

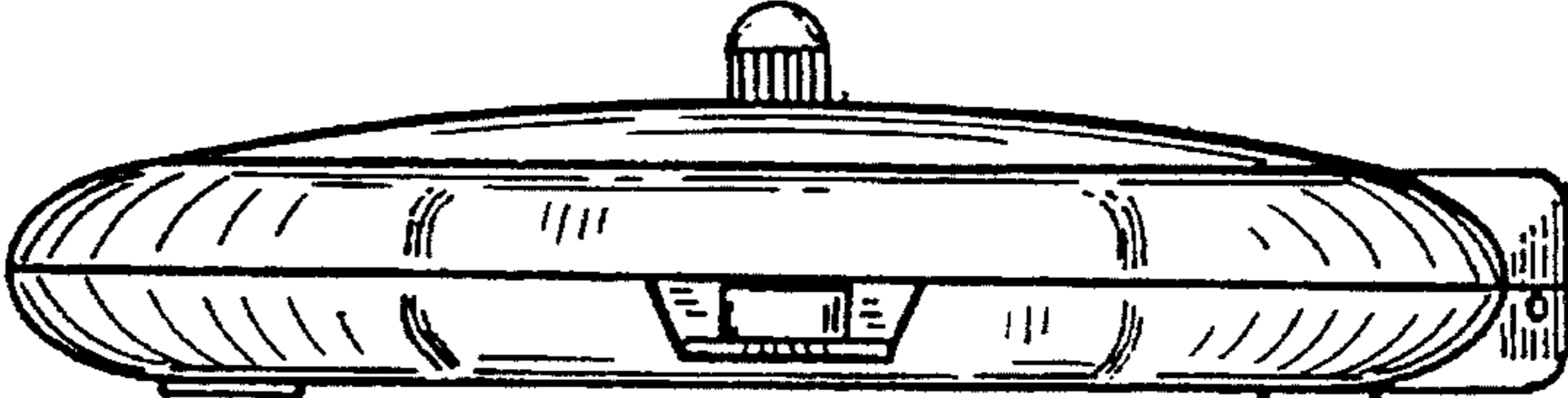

FIG. 8