



US00D366703S

# United States Patent [19]

Huen

[11] Patent Number: **Des. 366,703**

[45] Date of Patent: **\*\*Jan. 30, 1996**

[54] **COMBINED MASSAGER WITH INTERCHANGEABLE MASSAGING HEADS AND CHARGER**

[75] Inventor: **Hing-Wah Huen**, Kowloon, Hong Kong

[73] Assignee: **Fairform Mfg. Co. Ltd.**, Hong Kong

[\*\*] Term: **14 Years**

[21] Appl. No.: **16,893**

[22] Filed: **Dec. 29, 1993**

### [30] Foreign Application Priority Data

Nov. 16, 1993 [GB] United Kingdom ..... 2035208

[52] U.S. Cl. .... **D24/214**; D24/200

[58] Field of Search ..... D24/200, 214, D24/215; 128/44, 41, 45, 46, 62 R, 67, 24.1, 24.2, 32

### [56] References Cited

#### U.S. PATENT DOCUMENTS

D. 273,328 4/1984 Hastings et al. .... D24/214

D. 347,283 5/1994 Von Winckler ..... D24/200  
D. 350,396 9/1994 Wollman et al. .... D24/200  
3,063,443 11/1962 Wahl ..... 128/32  
3,699,952 10/1972 Waters et al. .... 128/24.2

*Primary Examiner*—Stella Reid  
*Attorney, Agent, or Firm*—Browning, Bushman, Anderson & Brookhart

### [57] CLAIM

The ornamental design for a combined massager with interchangeable massaging heads and charger, as shown and described.

### DESCRIPTION

FIG. 1 is a front, right side and top perspective view of the combined massager with interchangeable massaging heads and charger showing my new design;  
FIG. 2 is a front elevational view thereof;  
FIG. 3 is a left side elevational view thereof;  
FIG. 4 is a rear elevational view thereof;  
FIG. 5 is a right side elevational view thereof; and,  
FIG. 6 is a top plan view thereof.

**1 Claim, 3 Drawing Sheets**

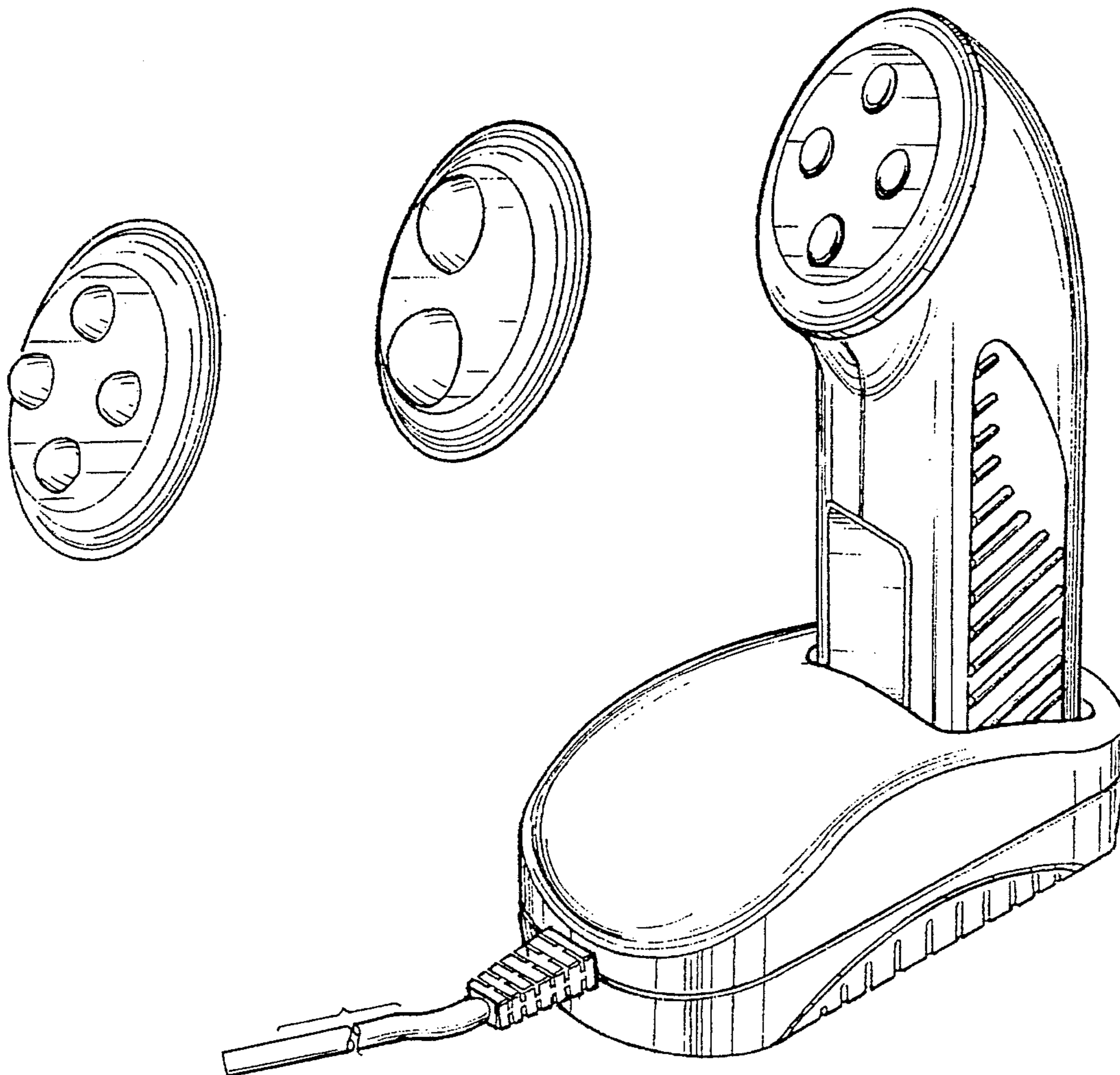
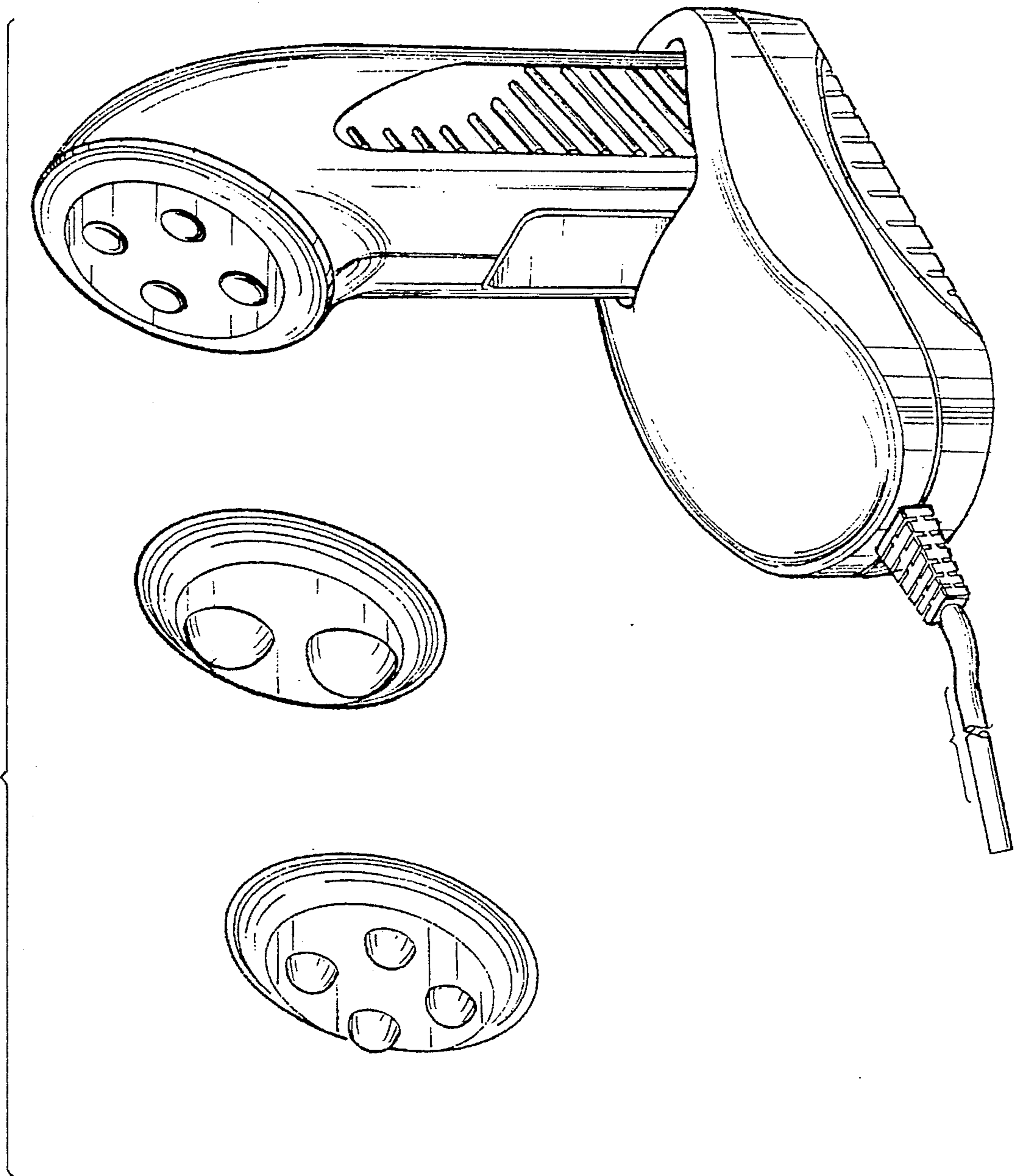

FIG. 1



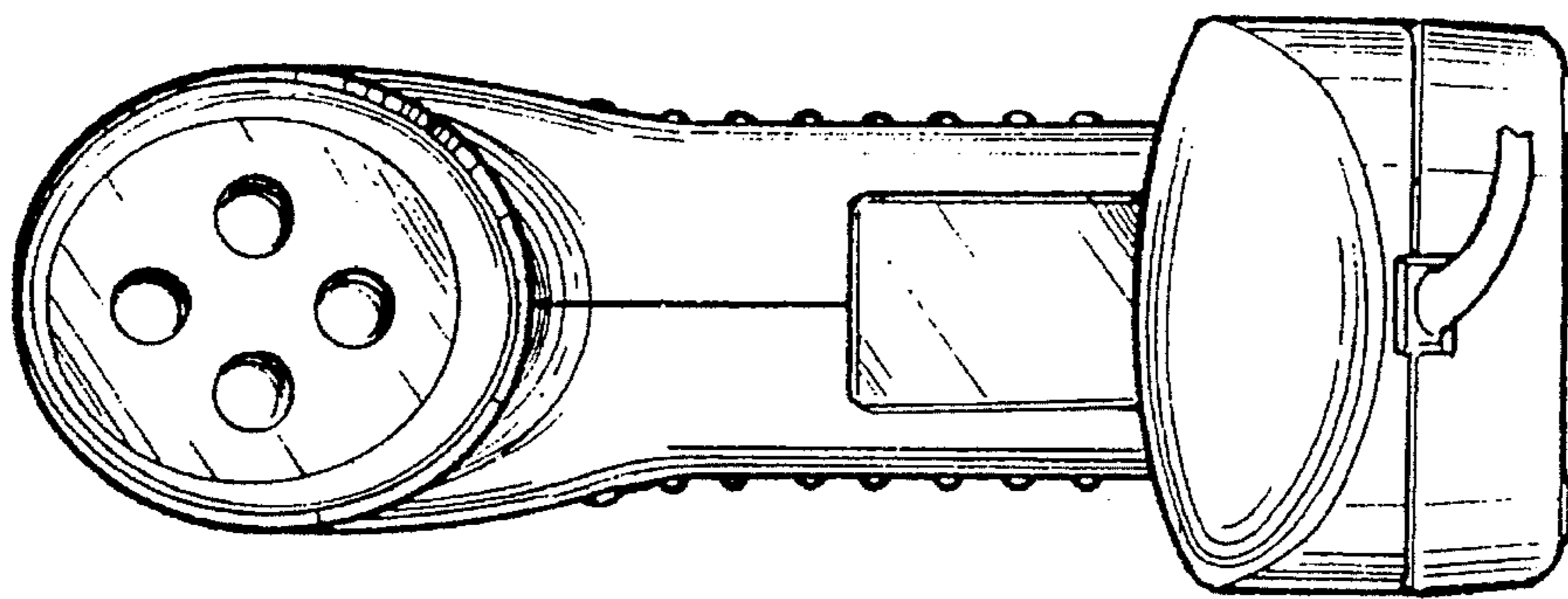

FIG. 2

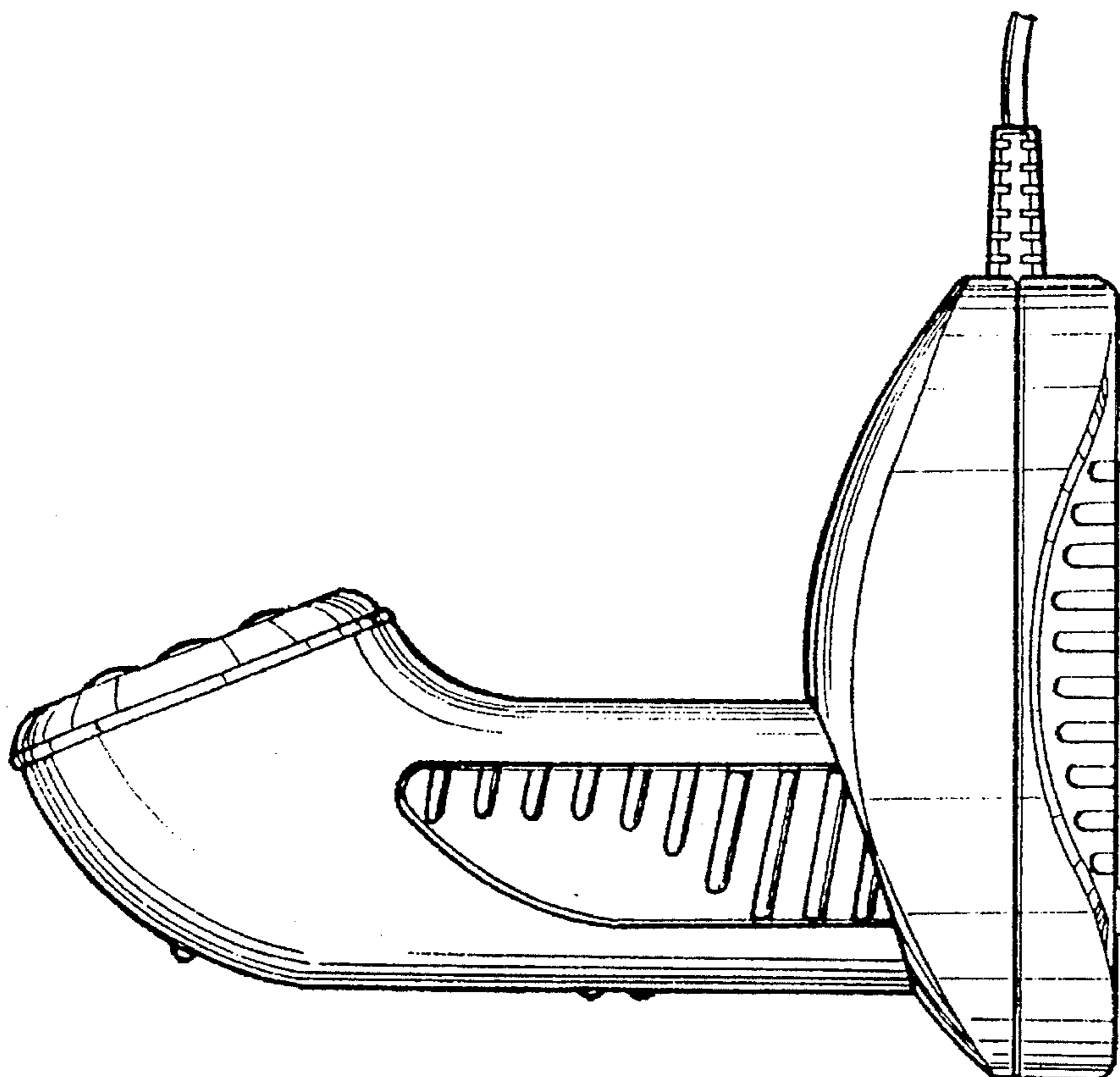

FIG. 3

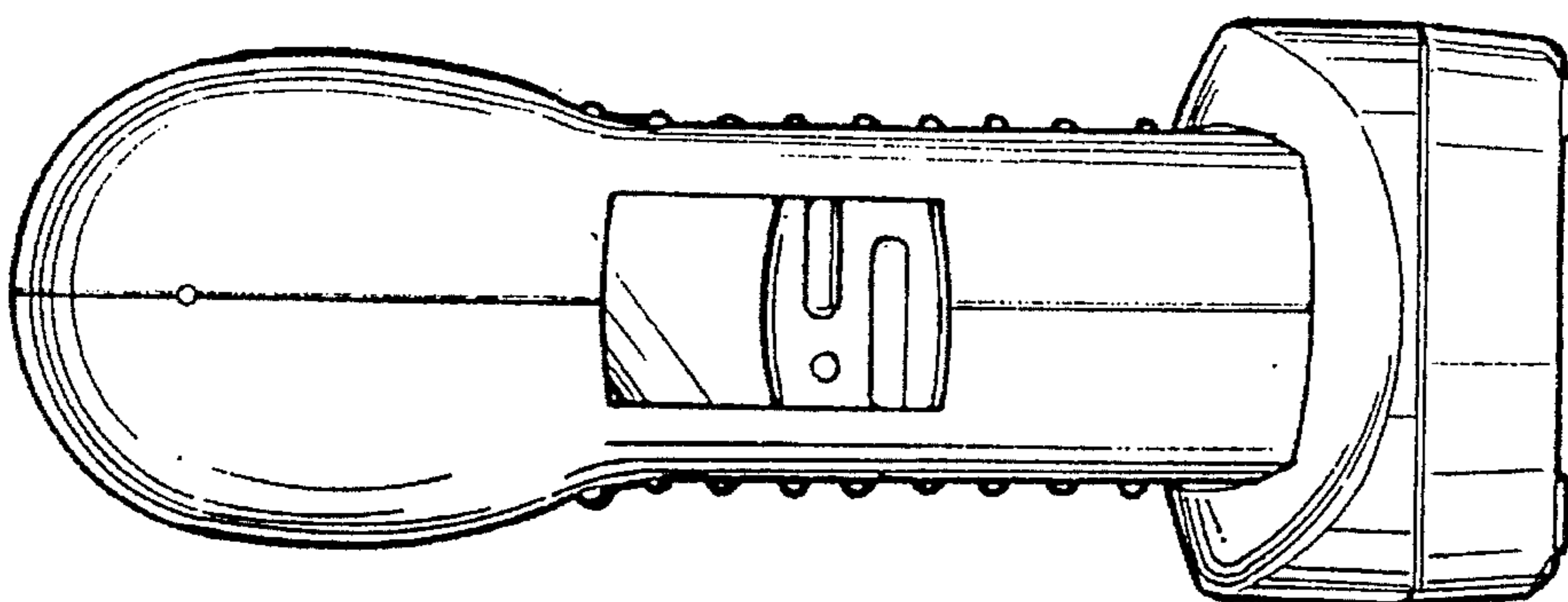

FIG. 4

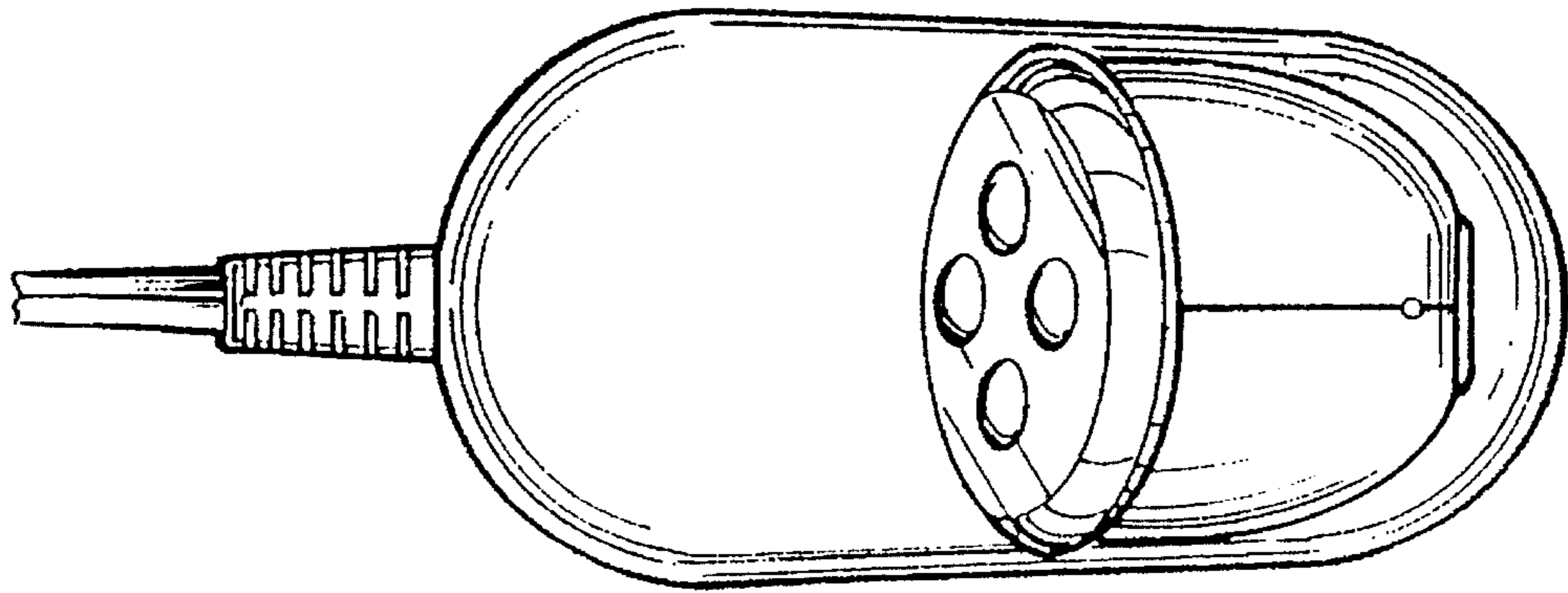

FIG. 6

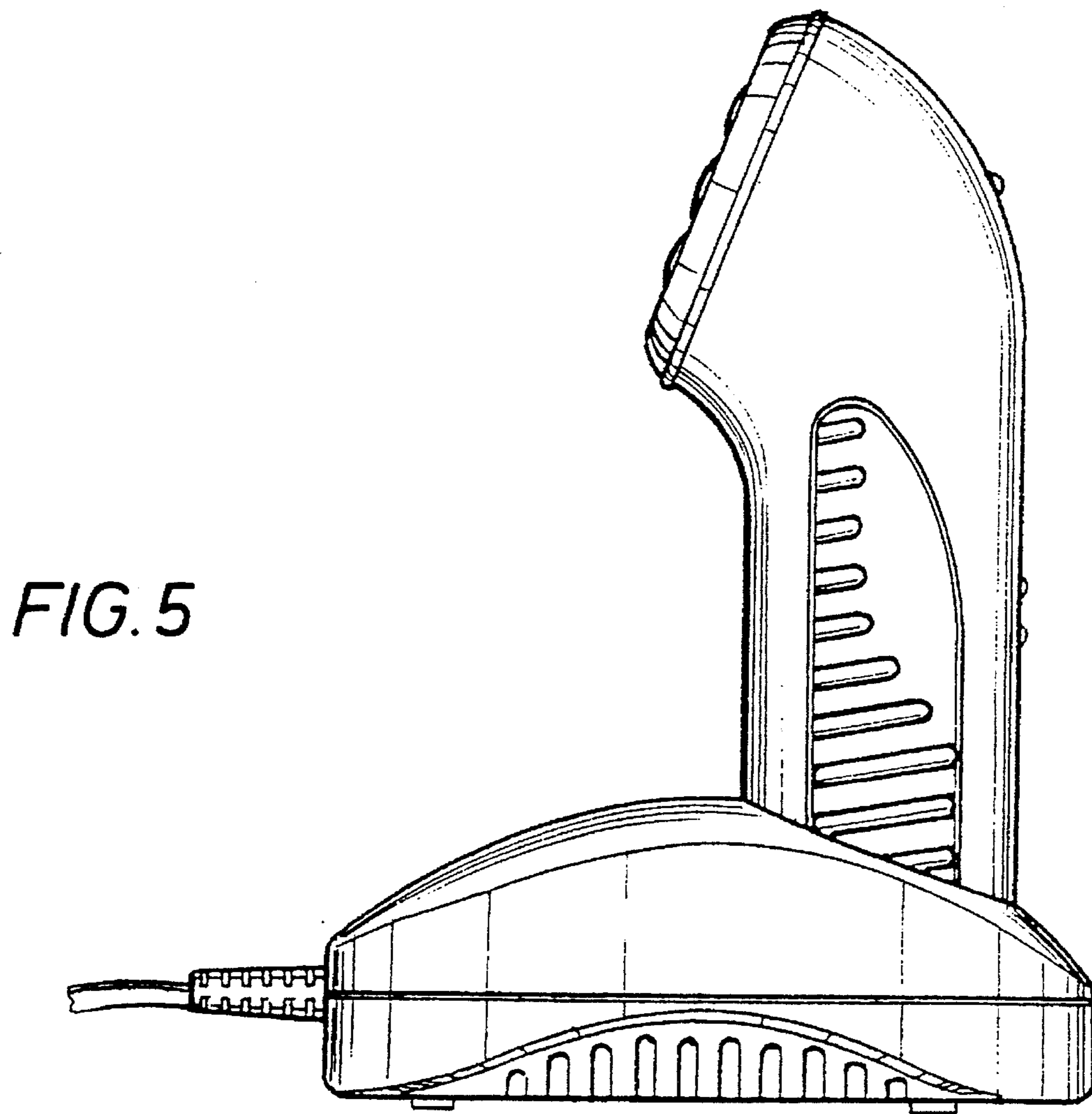

FIG. 5