



US00D366620S

United States Patent [19]

[11] **Patent Number: Des. 366,620**

Kuzma et al.

[45] **Date of Patent: **Jan. 30, 1996**

[54] **COMBINED BOTTLE AND CAP**

[75] Inventors: **Gene J. Kuzma**, Columbus; **Douglas W. Weaver**, Troy, both of Ohio

[73] Assignee: **G K Packaging, Inc.**, Columbus, Ohio

[**] Term: **14 Years**

[21] Appl. No.: **25,319**

[22] Filed: **Jun. 28, 1994**

[52] U.S. Cl. **D9/542; D9/566; D9/573**

[58] Field of Search **D9/544, 572, 573, D9/574, 575, 566, 542, 562; 215/1 R, 1 C**

[56] **References Cited**

U.S. PATENT DOCUMENTS

D. 94,189	1/1935	Cassedy .	
D. 175,447	8/1955	Tucker	D9/566 X
D. 194,809	5/1963	DuPree	D9/544
D. 197,487	2/1964	Lorenzen	D58/8
D. 230,709	3/1974	Cooper	D9/1
D. 235,007	4/1975	Braun	D9/1
D. 236,586	9/1975	McDonald	D9/574
D. 243,827	3/1977	Ruriani	D9/1
D. 247,095	1/1978	Weckman	D9/1
D. 272,988	3/1984	Podall et al.	D9/300
D. 276,791	12/1984	Field	D9/573 X
D. 285,054	8/1986	Stones	D9/542
D. 317,869	7/1991	Kipperman et al.	D9/446
D. 318,012	7/1991	Kipperman et al.	D9/403
D. 318,037	7/1991	Kipperman et al.	D9/403
D. 318,423	7/1991	Kipperman et al.	D9/403
D. 318,424	7/1991	Kipperman et al.	D9/403
D. 318,425	7/1991	Kipperman et al.	D9/403
D. 318,619	7/1991	Kipperman et al.	D9/403

(List continued on next page.)

FOREIGN PATENT DOCUMENTS

65467 2/1990 Canada .

Primary Examiner—Lucy Lieberman
Attorney, Agent, or Firm—John L. Gray

[57] **CLAIM**

The ornamental design for a combined bottle and cap, as shown and described.

DESCRIPTION

FIG. 1 is a top, front and right side perspective view of a combined bottle and cap showing our new design;
 FIG. 2 is a right side elevation thereof, the left side elevation is the same;
 FIG. 3 is a front elevation thereof, the rear elevation is the same;
 FIG. 4 is a top plan view thereof;
 FIG. 5 is a bottom plan view thereof;
 FIG. 6 is a top, front and right side perspective view of a second embodiment of the combined bottle and cap;
 FIG. 7 is a right side elevation of FIG. 6, the left side elevation is the same;
 FIG. 8 is a front elevation of FIG. 6, the rear elevation is the same;
 FIG. 9 is a top plan view of the combined bottle and cap shown in FIG. 6;
 FIG. 10 is a bottom plan view of the combined bottle and cap as shown in FIG. 6;
 FIG. 11 is a top, front and right side perspective view of a third embodiment of the combined bottle and cap;
 FIG. 12 is a right side elevation of FIG. 11, the left side elevation is the same;
 FIG. 13 is a front elevation of FIG. 11, the rear elevation is the same;
 FIG. 14 is a top plan view of the combined bottle and cap shown in FIG. 11;
 FIG. 15 is a bottom plan view of the combined bottle and cap as shown in FIG. 11;
 FIG. 16 is a top, front and right side perspective view of a fourth embodiment of the combined bottle and cap;
 FIG. 17 is a right side elevation of FIG. 16, the left side elevation is a mirror image thereof;
 FIG. 18 is a front elevation thereof, the rear elevation is the same except that the rear of the cap lacks the indentation on the front of the cap and has a conventional hinge which is shown in FIGS. 17 and 19;
 FIG. 19 is a top plan view of the combined bottle and cap shown in FIG. 16 and,
 FIG. 20 is a bottle plan view of the combined bottle and cap as shown in FIG. 16.

1 Claim, 4 Drawing Sheets

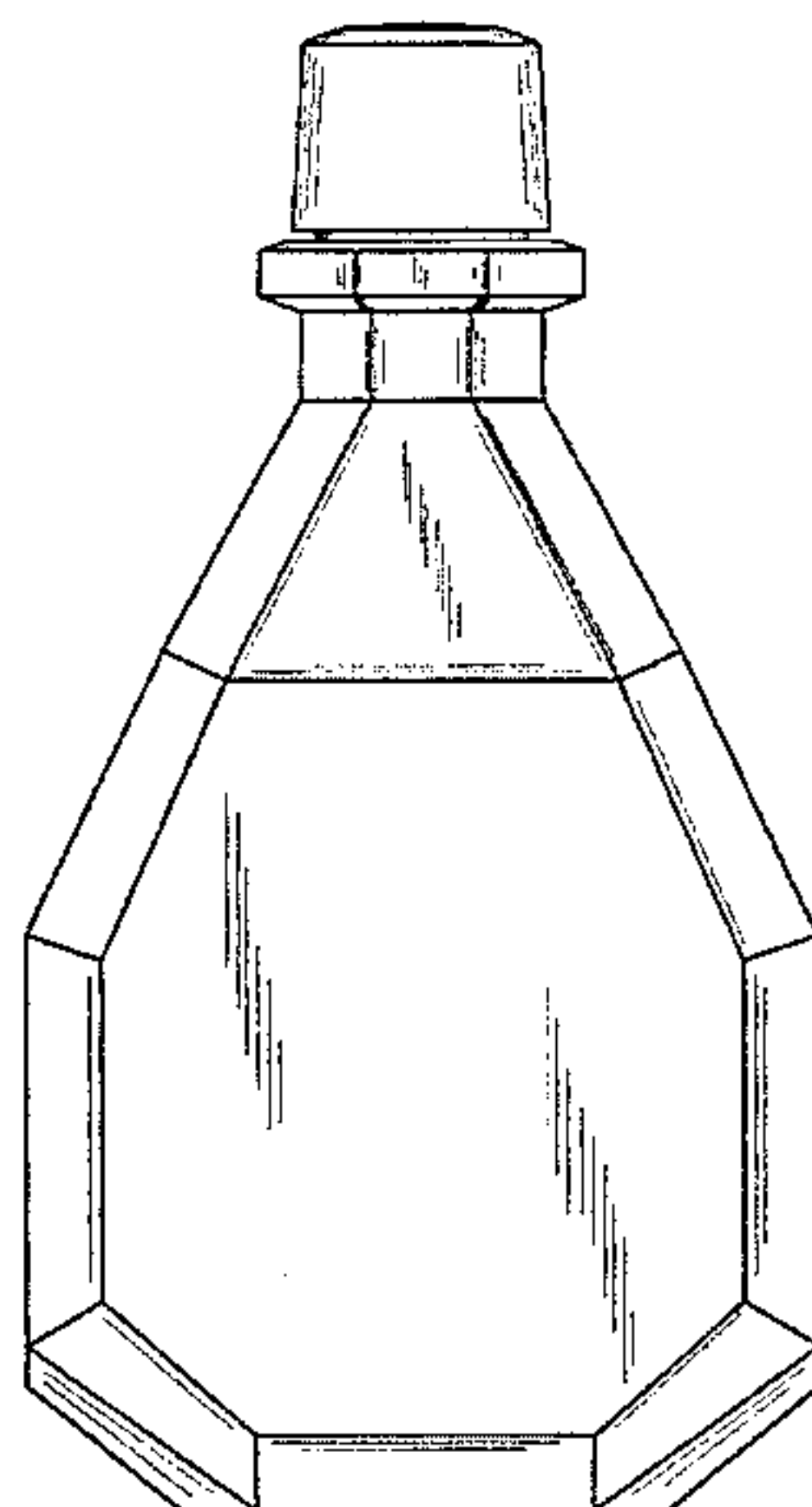

U.S. PATENT DOCUMENTS

D. 318,620	7/1991	Kipperman et al.	D9/403	D. 319,582	9/1991	Crawford	D9/367
D. 318,801	8/1991	Kipperman et al.	D9/403	D. 322,216	12/1991	Zogg et al.	D9/367
D. 319,012	8/1991	Kipperman et al.	D9/403	D. 322,538	4/1993	Bolen, Jr. et al.	D9/447
D. 319,013	8/1991	Kipperman et al.	D9/403	D. 322,756	12/1991	Kipperman et al.	D9/403
D. 319,391	8/1991	Kipperman et al.	D9/403	D. 328,247	7/1992	Robineau	D9/544 X

FIG. 1

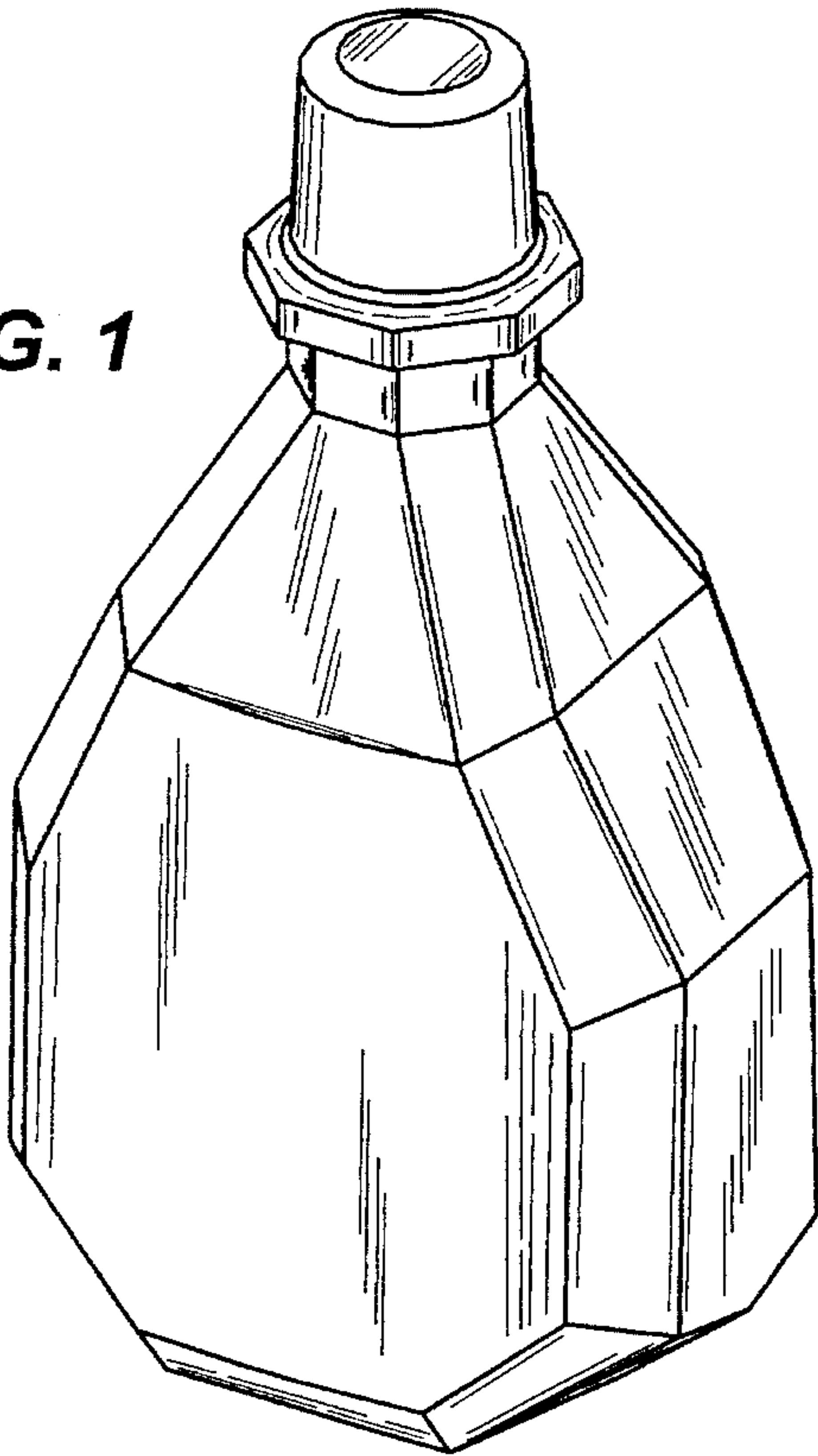

FIG. 2

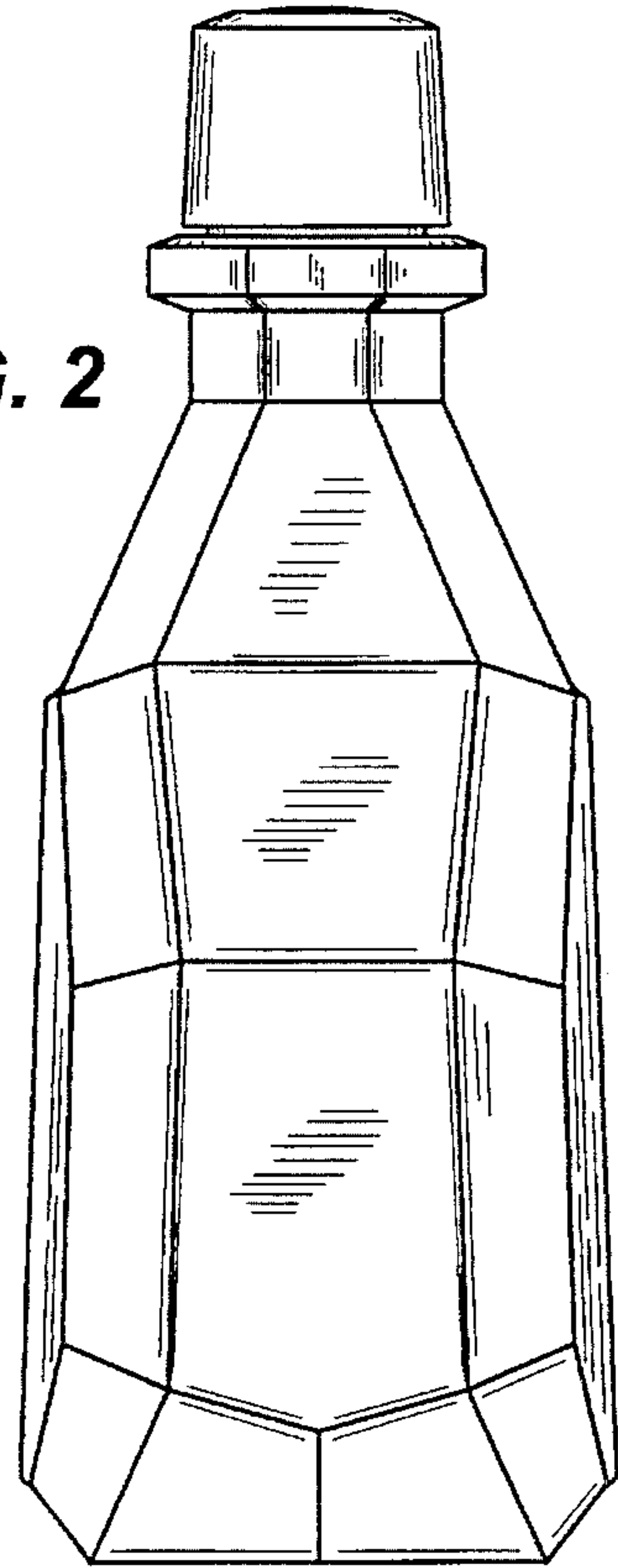

FIG. 3

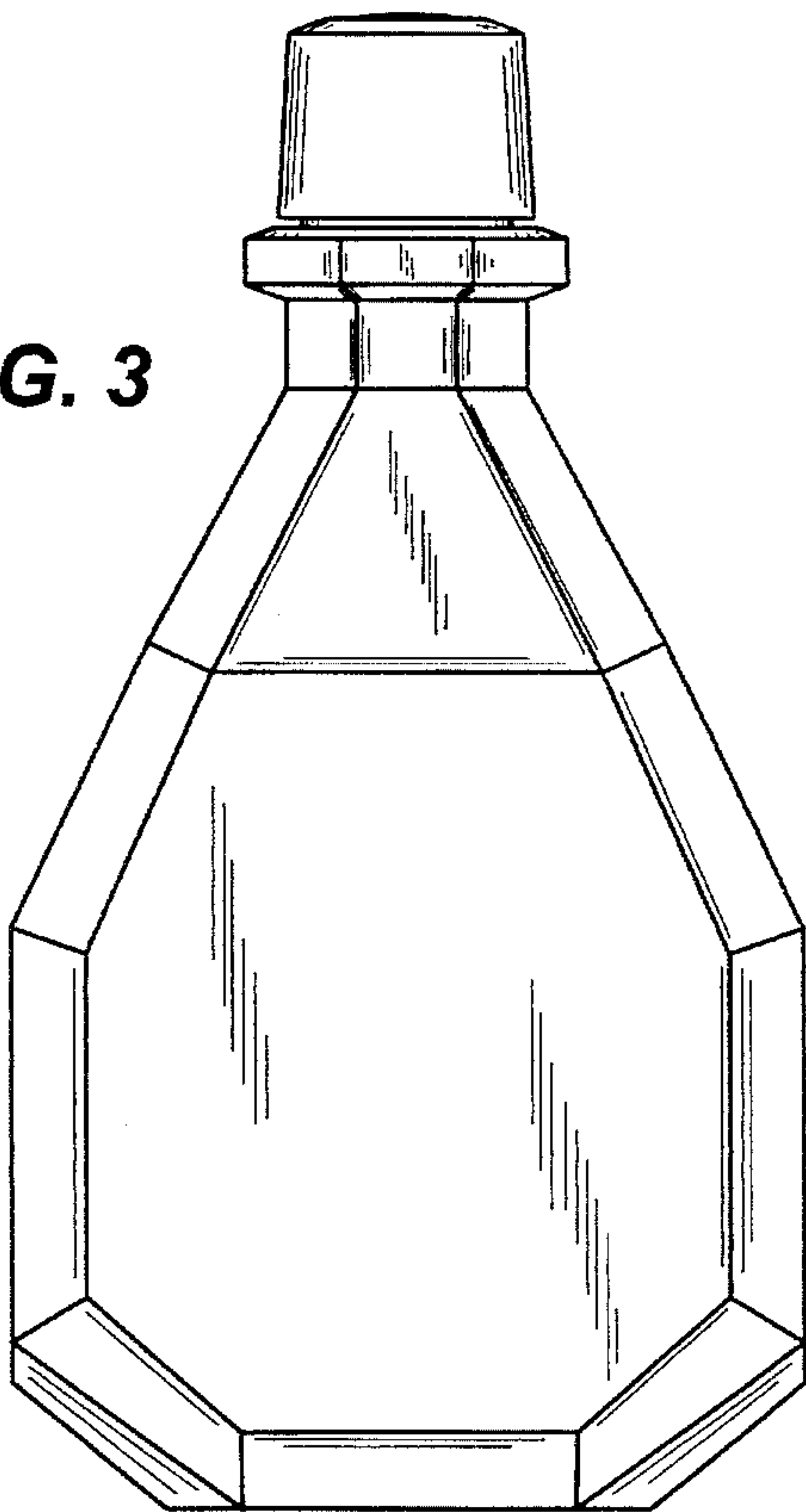

FIG. 4

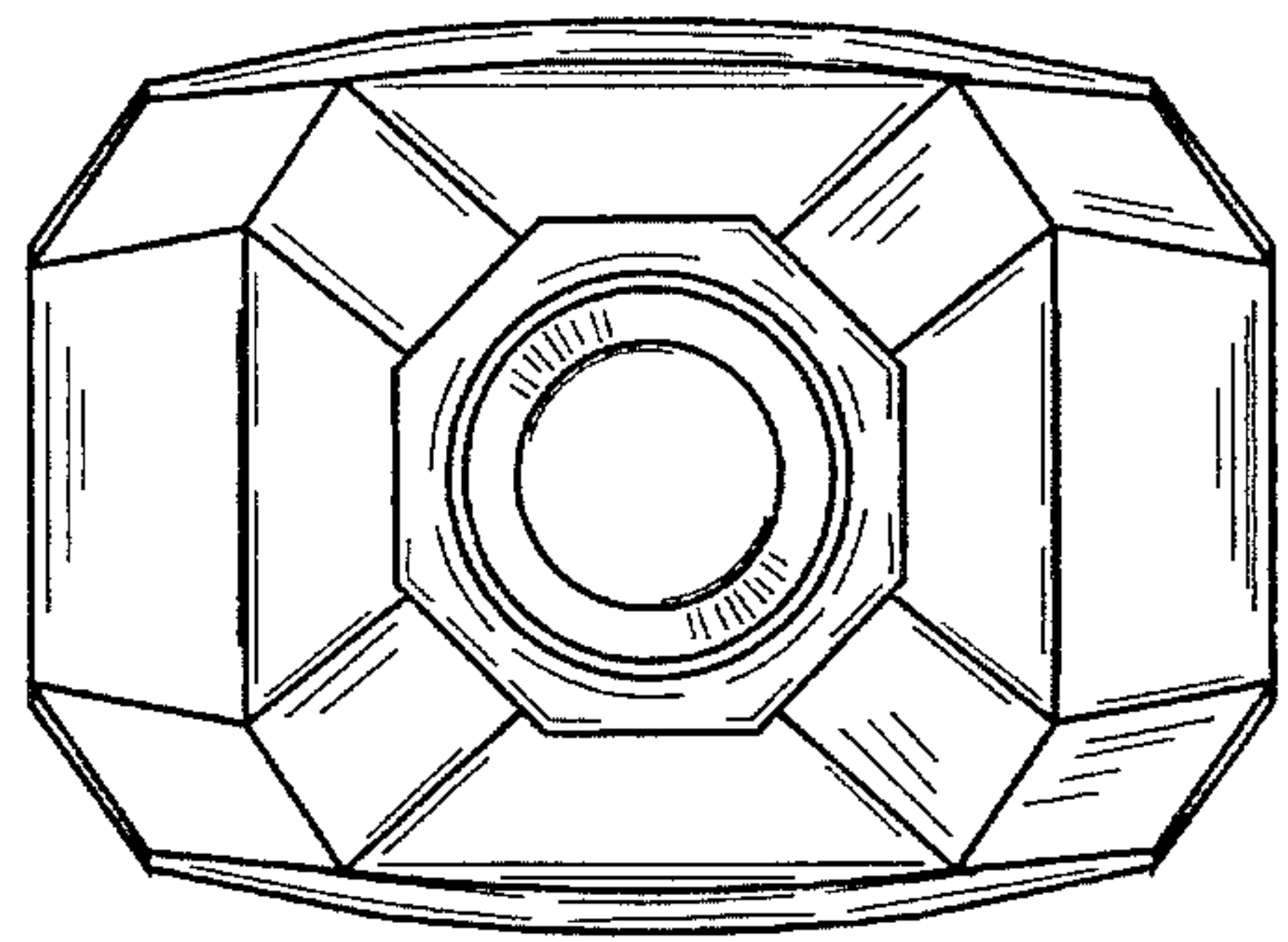

FIG. 5

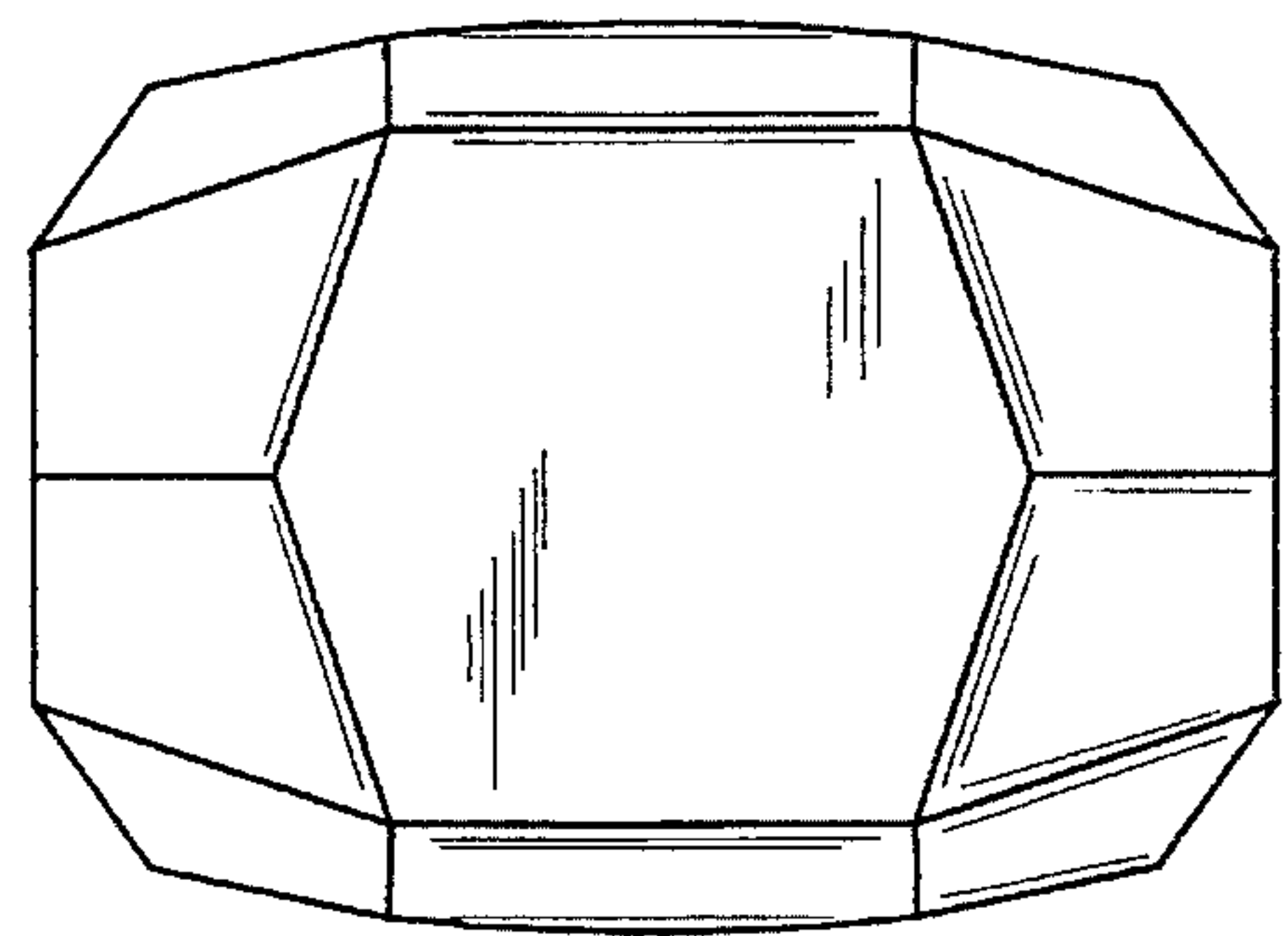

FIG. 6

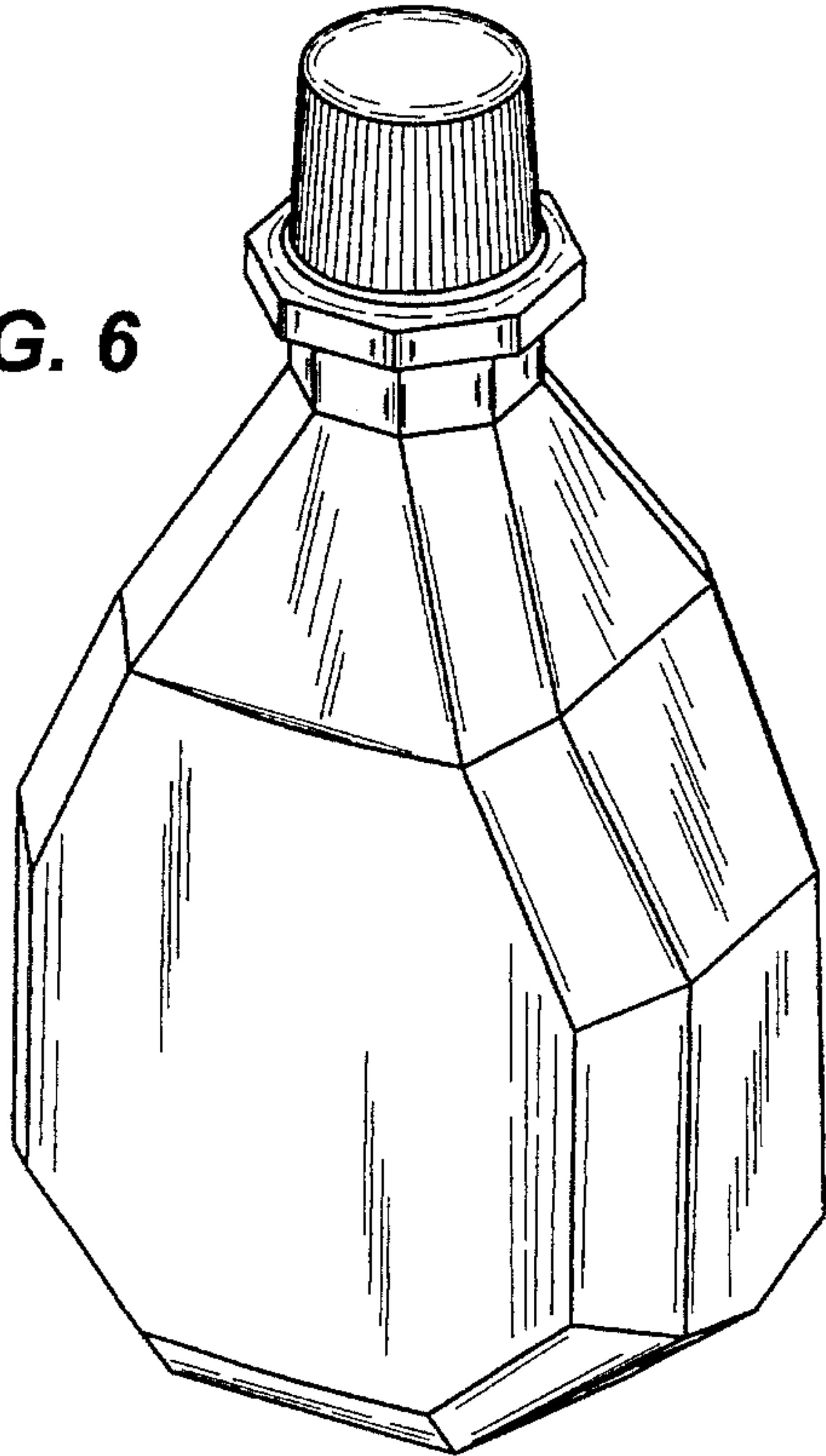

FIG. 7

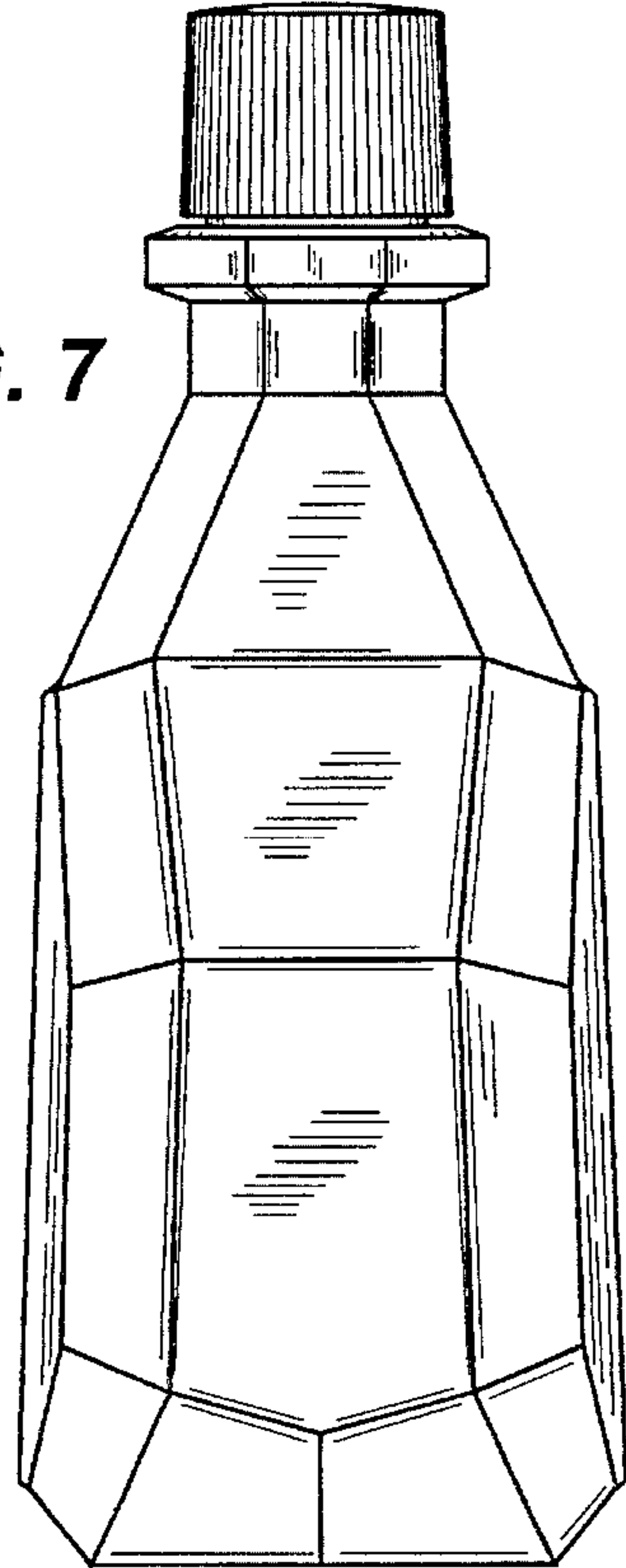

FIG. 8

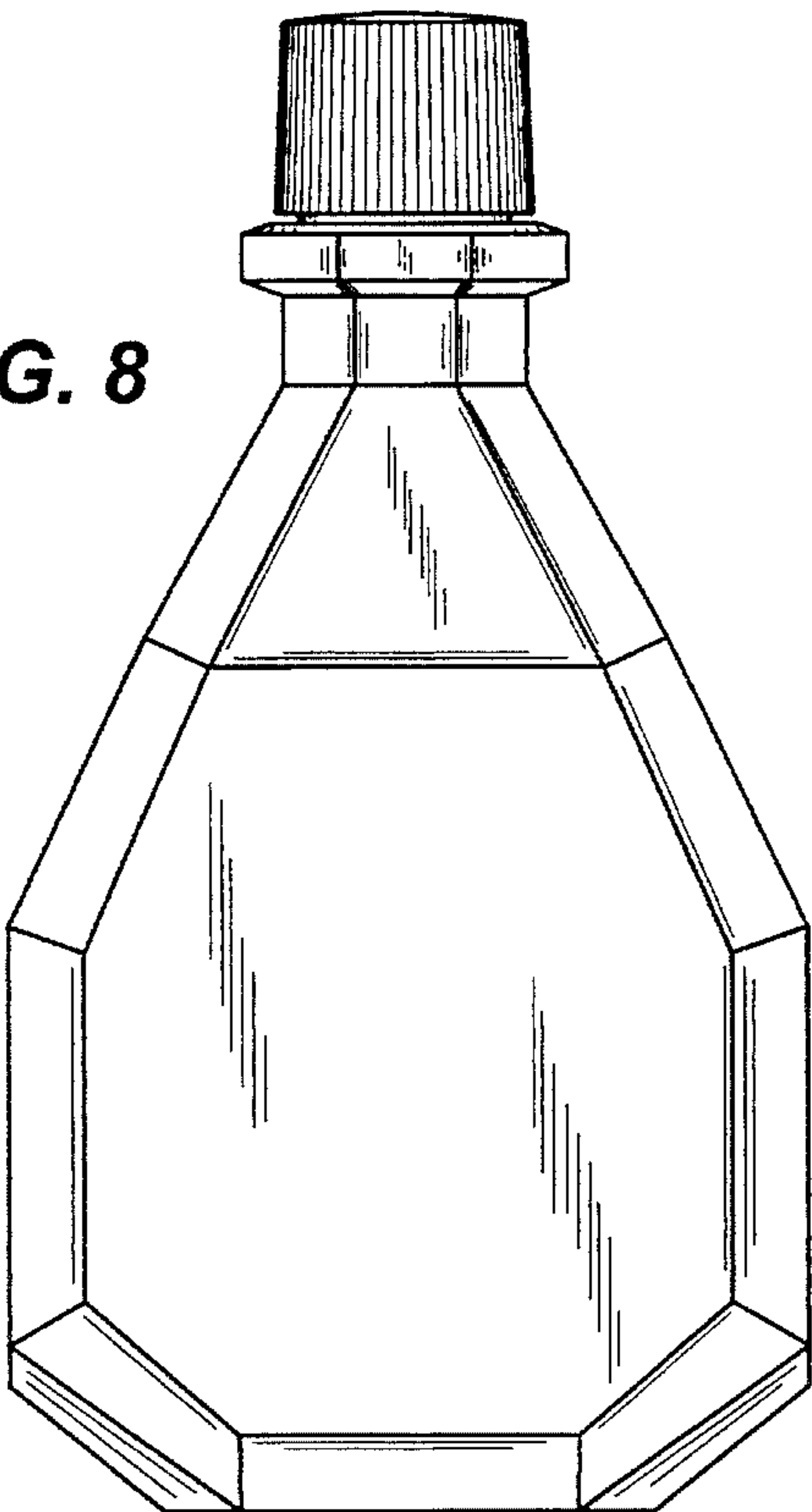

FIG. 9

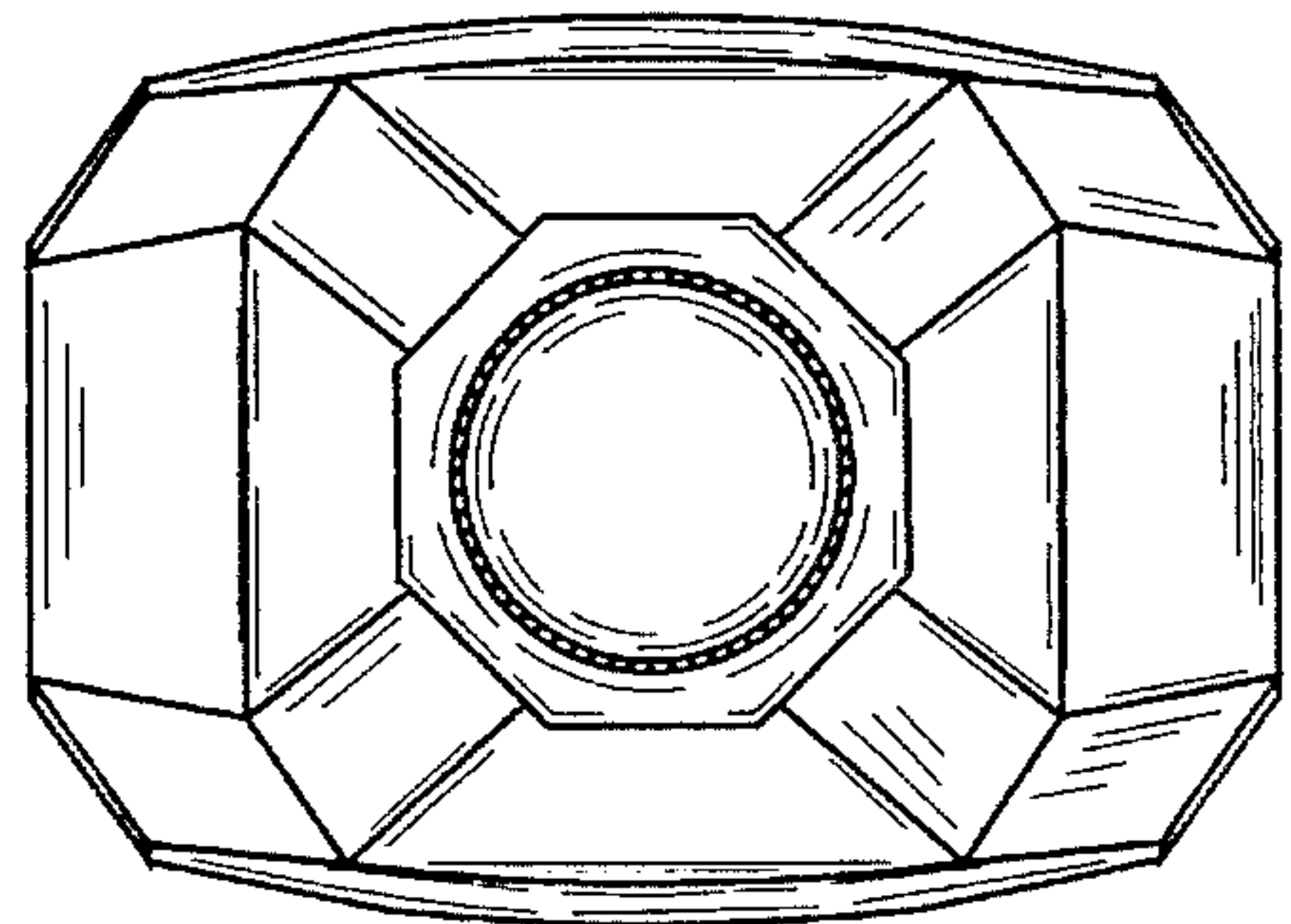

FIG. 10

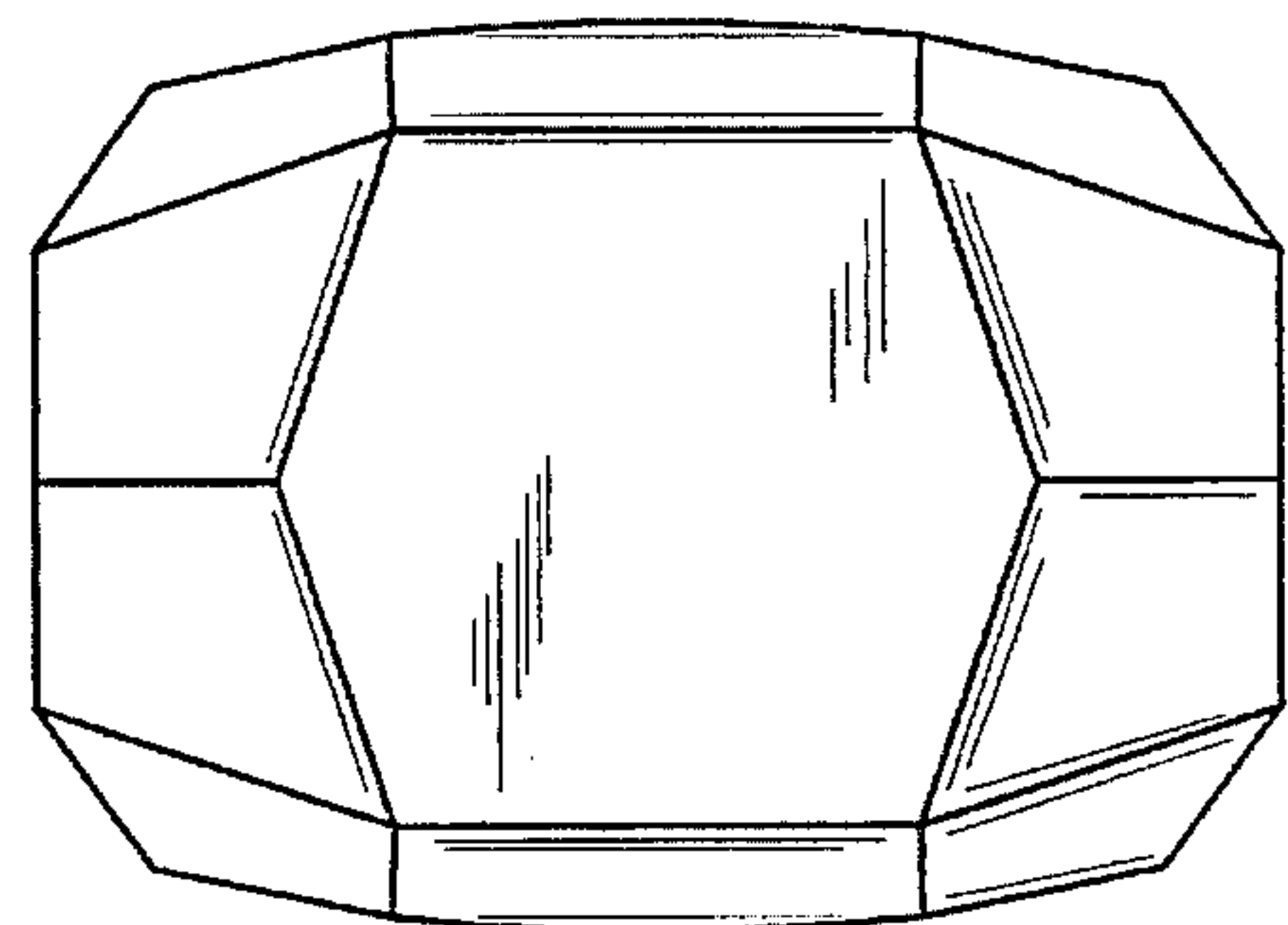

FIG. 11

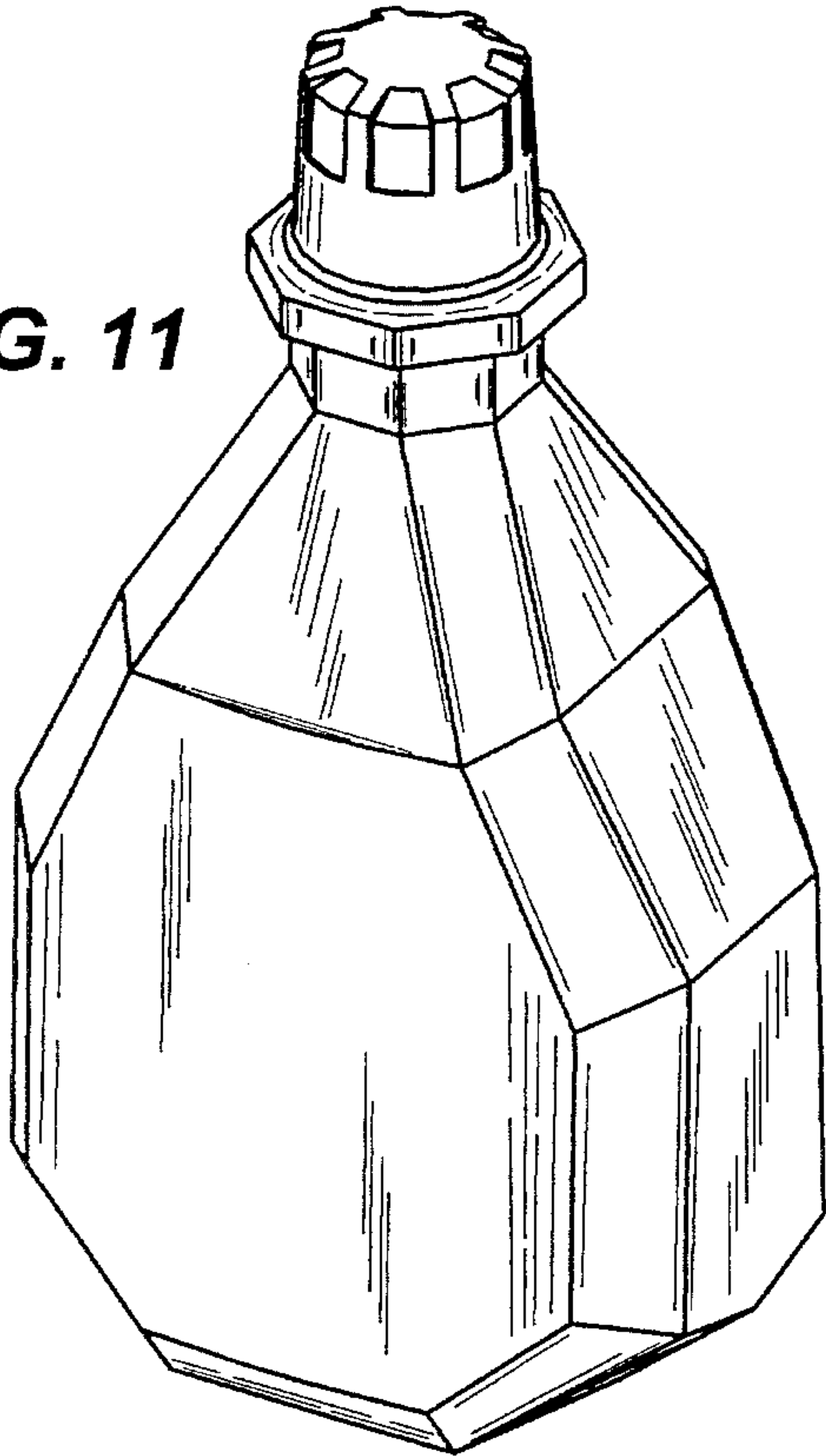

FIG. 12

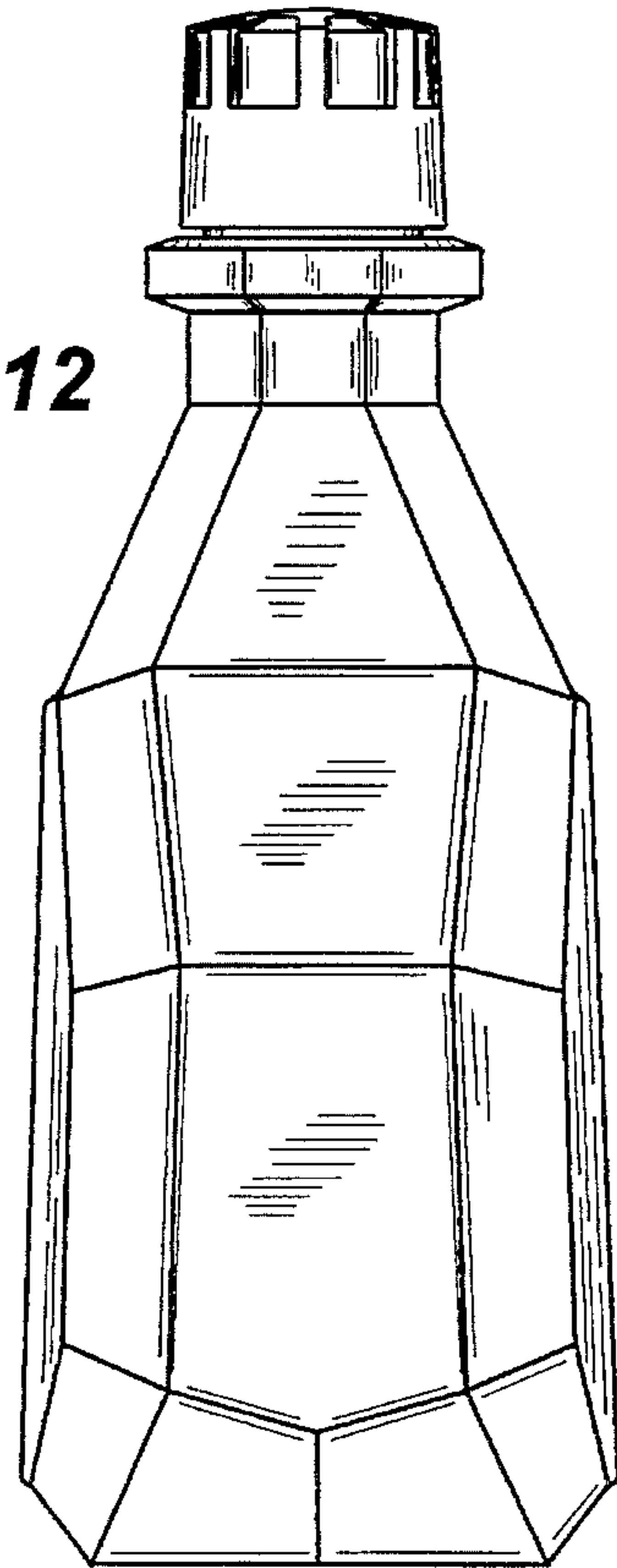

FIG. 13

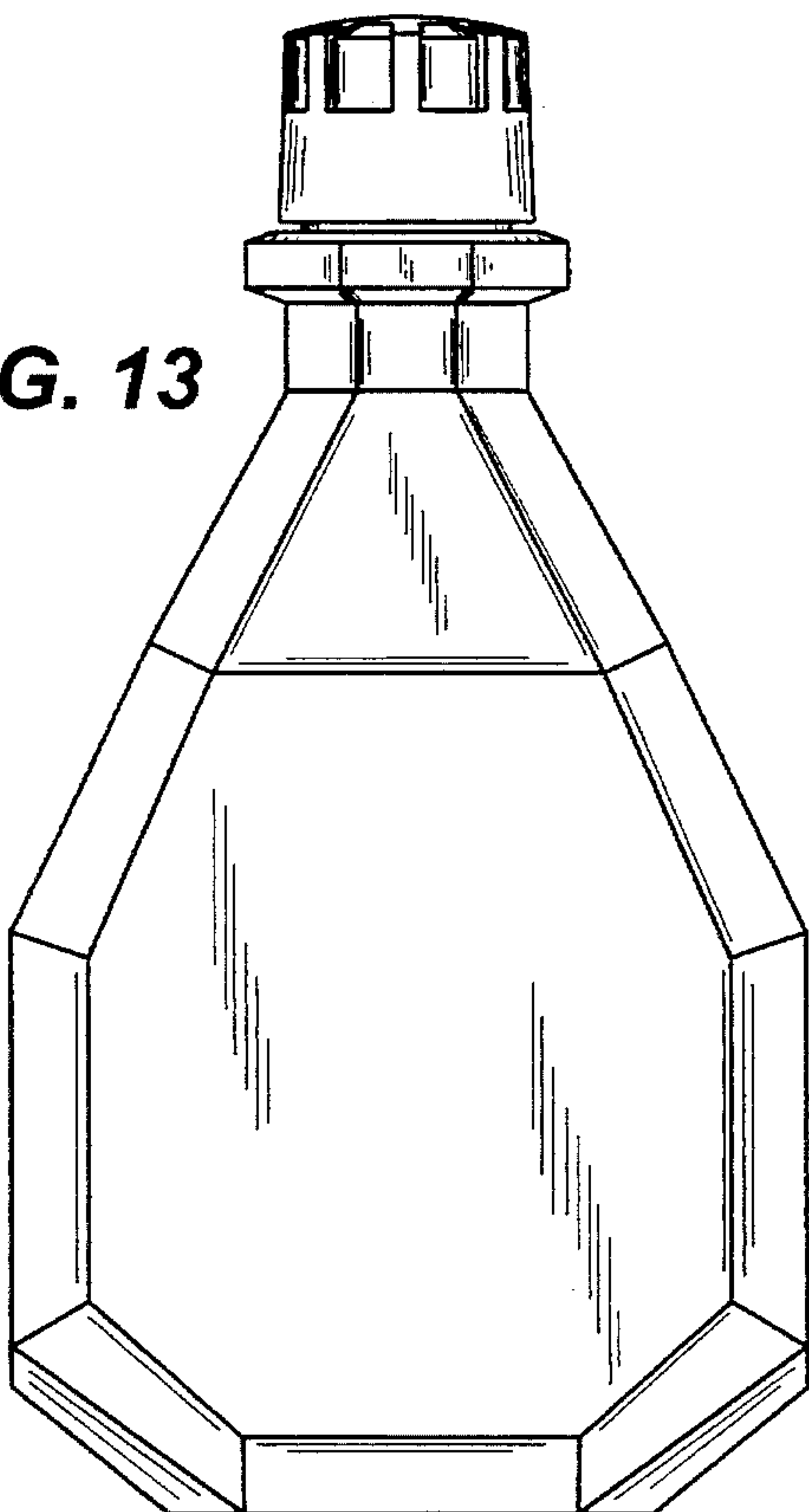

FIG. 14

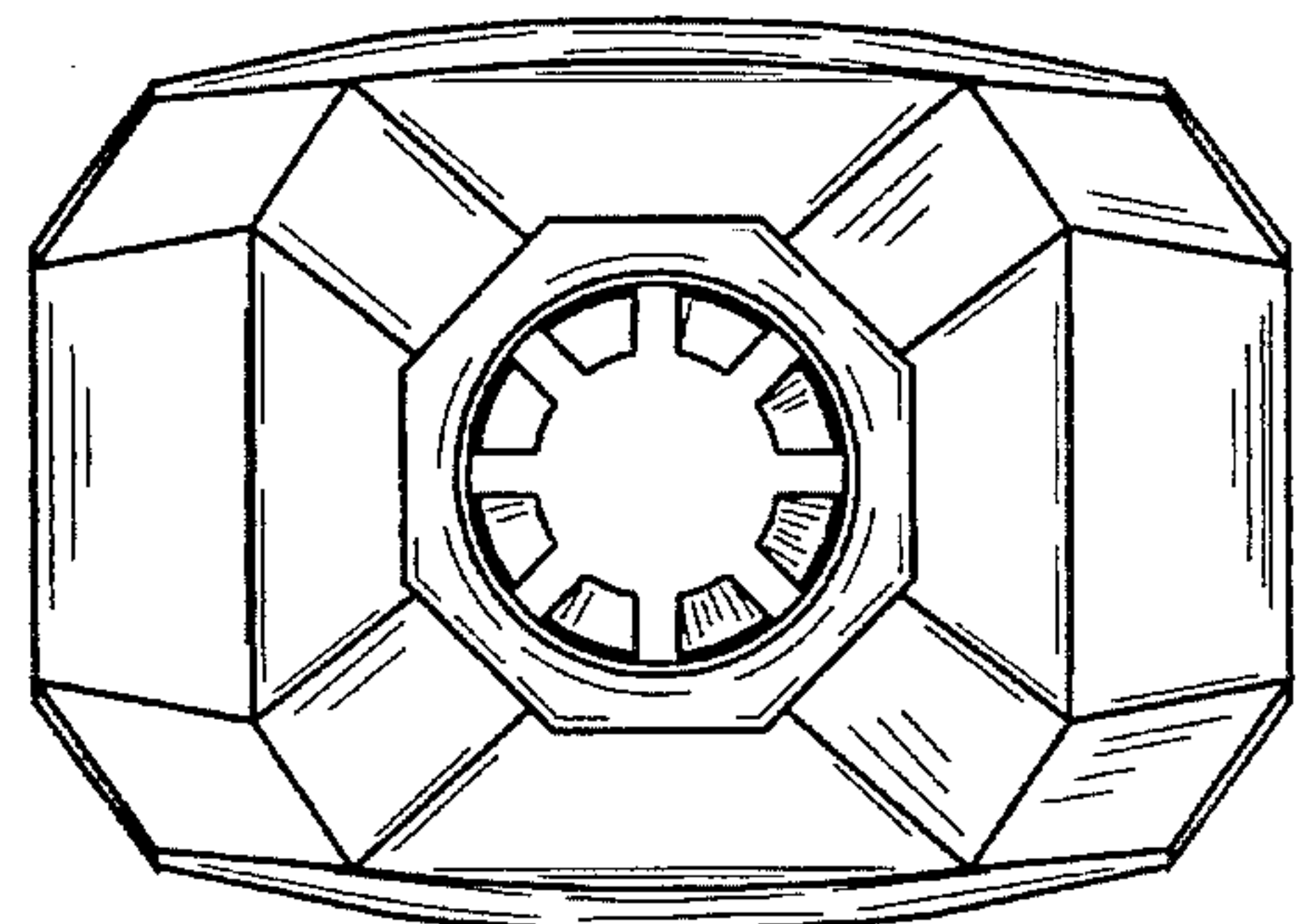

FIG. 15

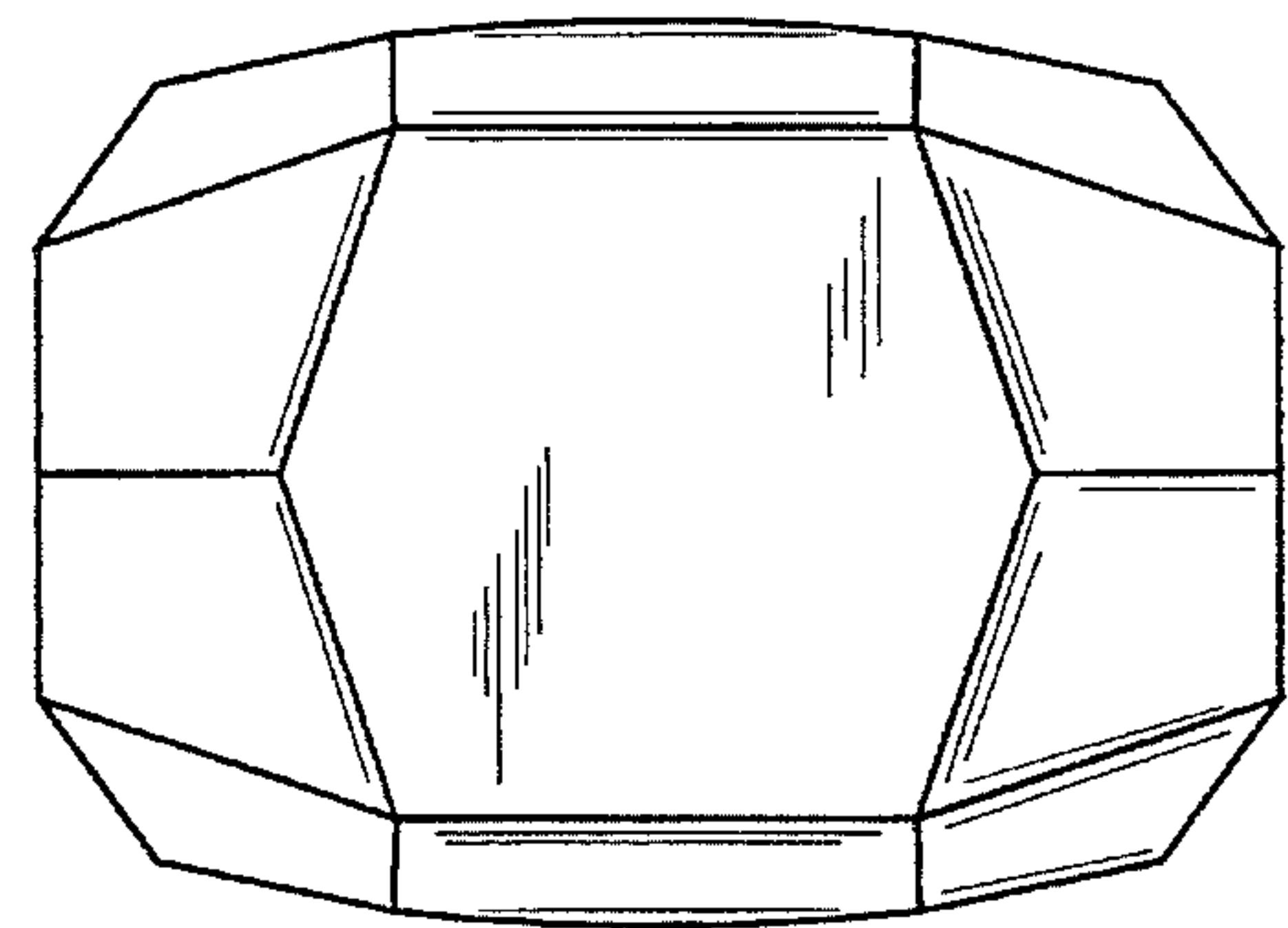

FIG. 16

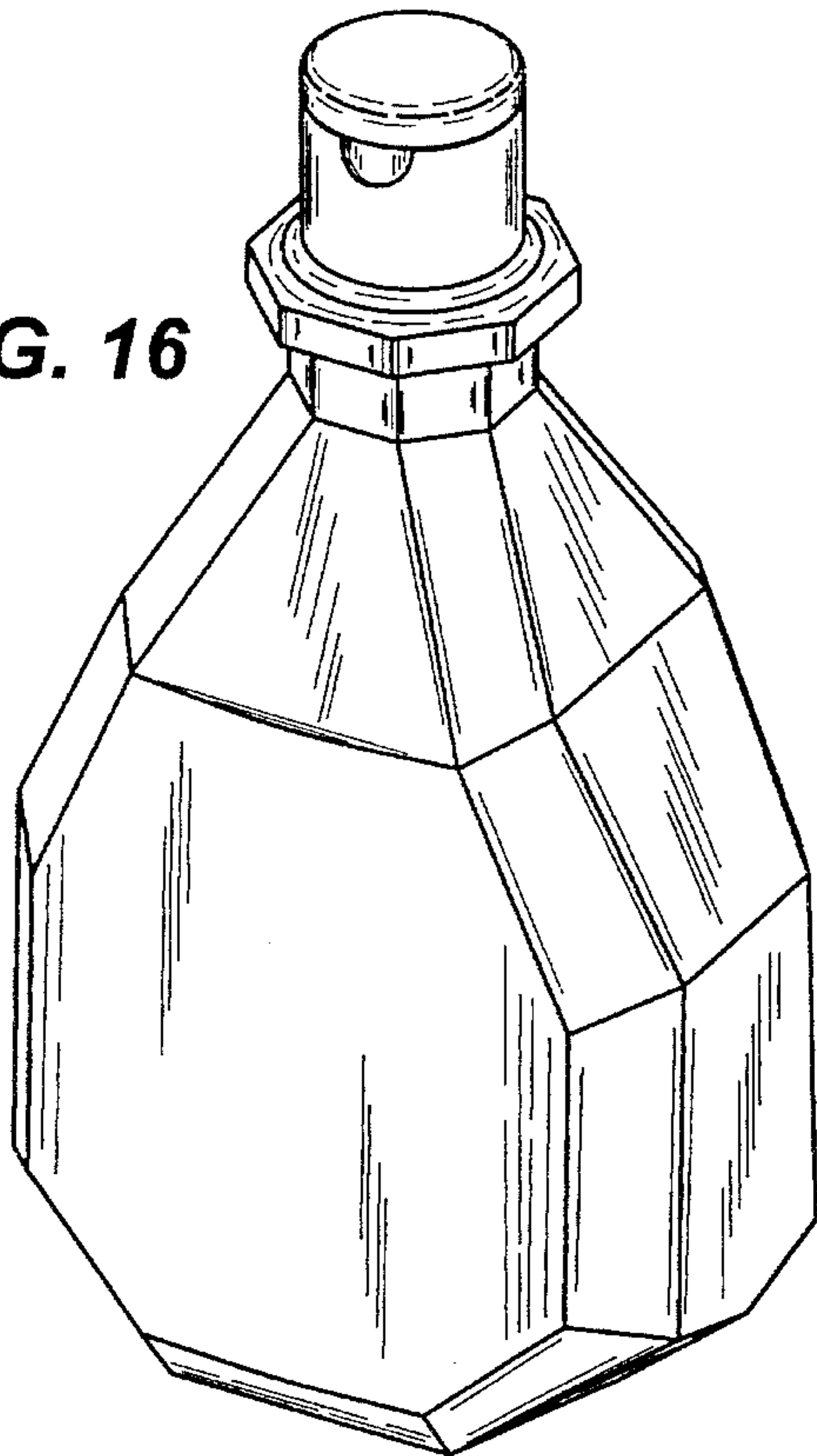

FIG. 17

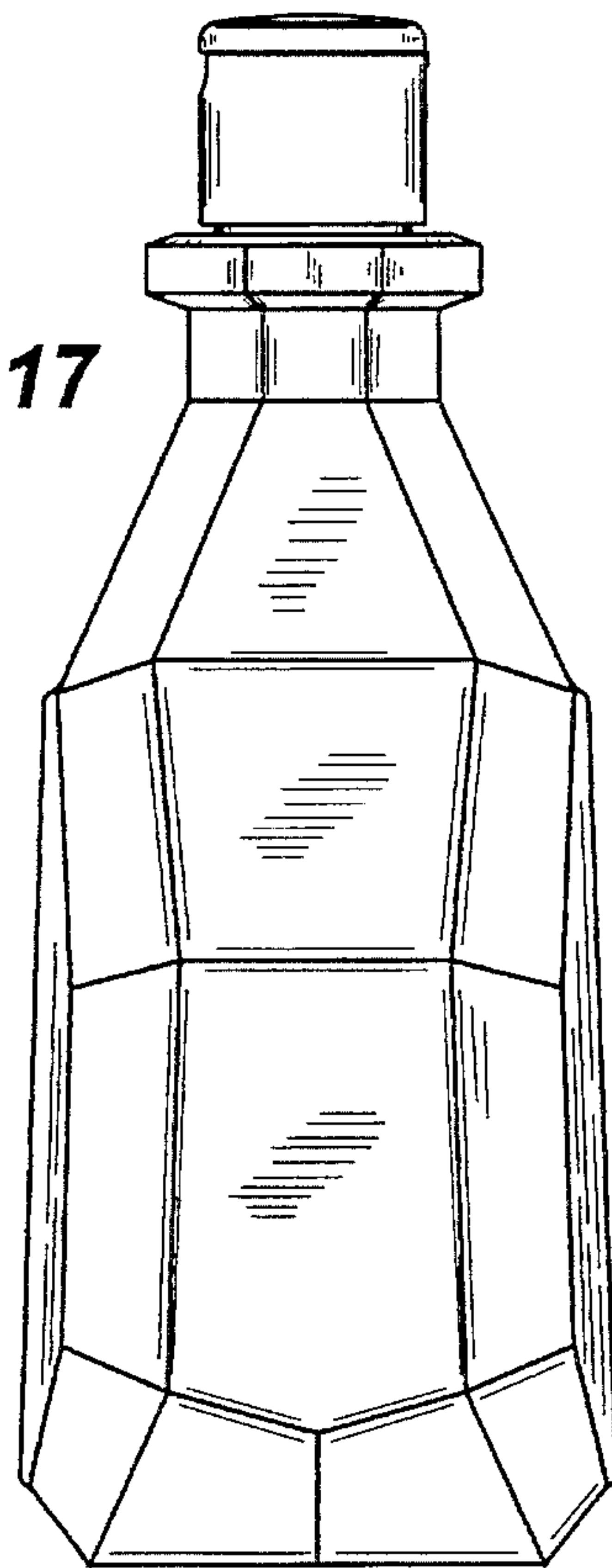

FIG. 18

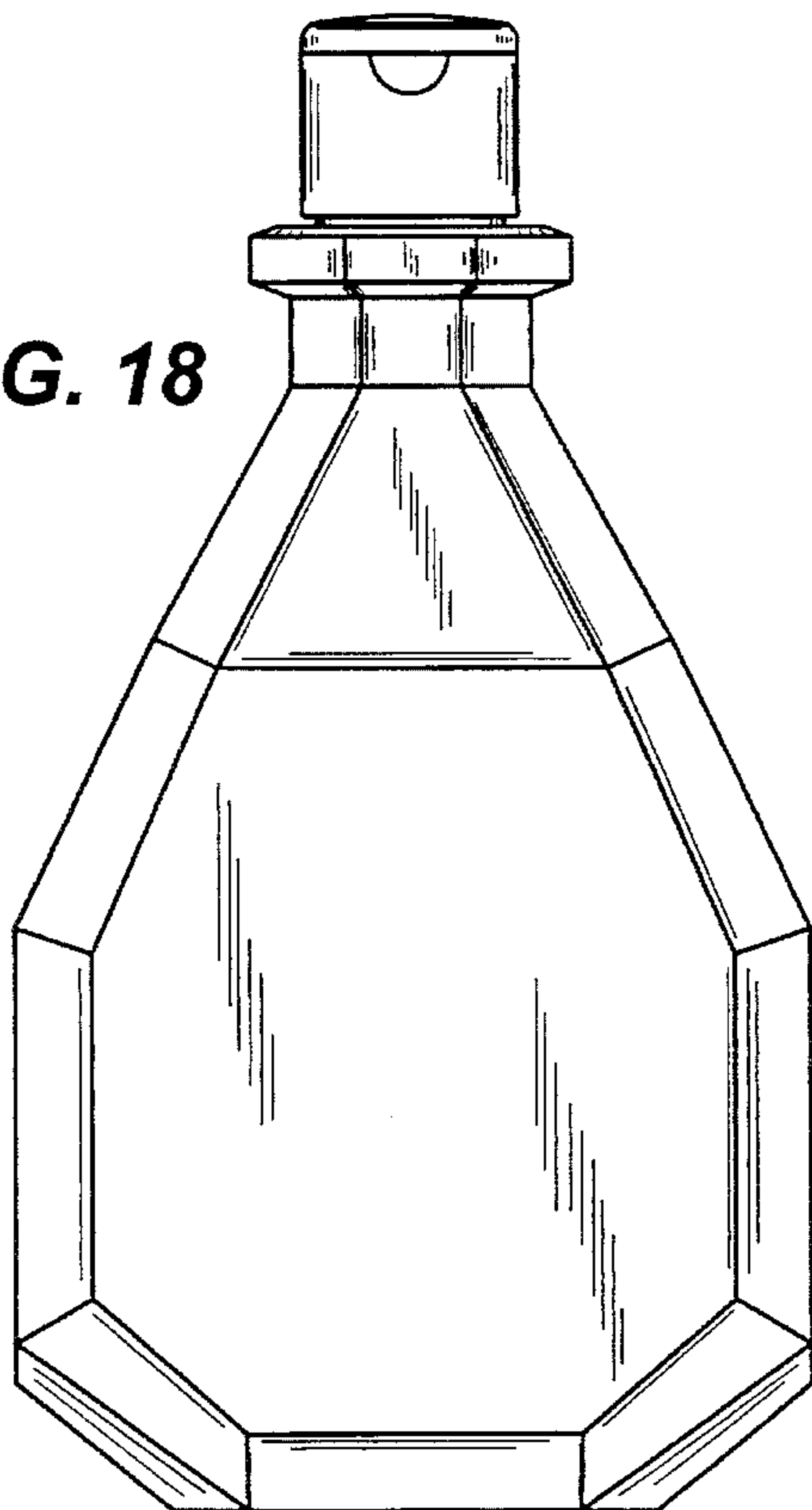

FIG. 19

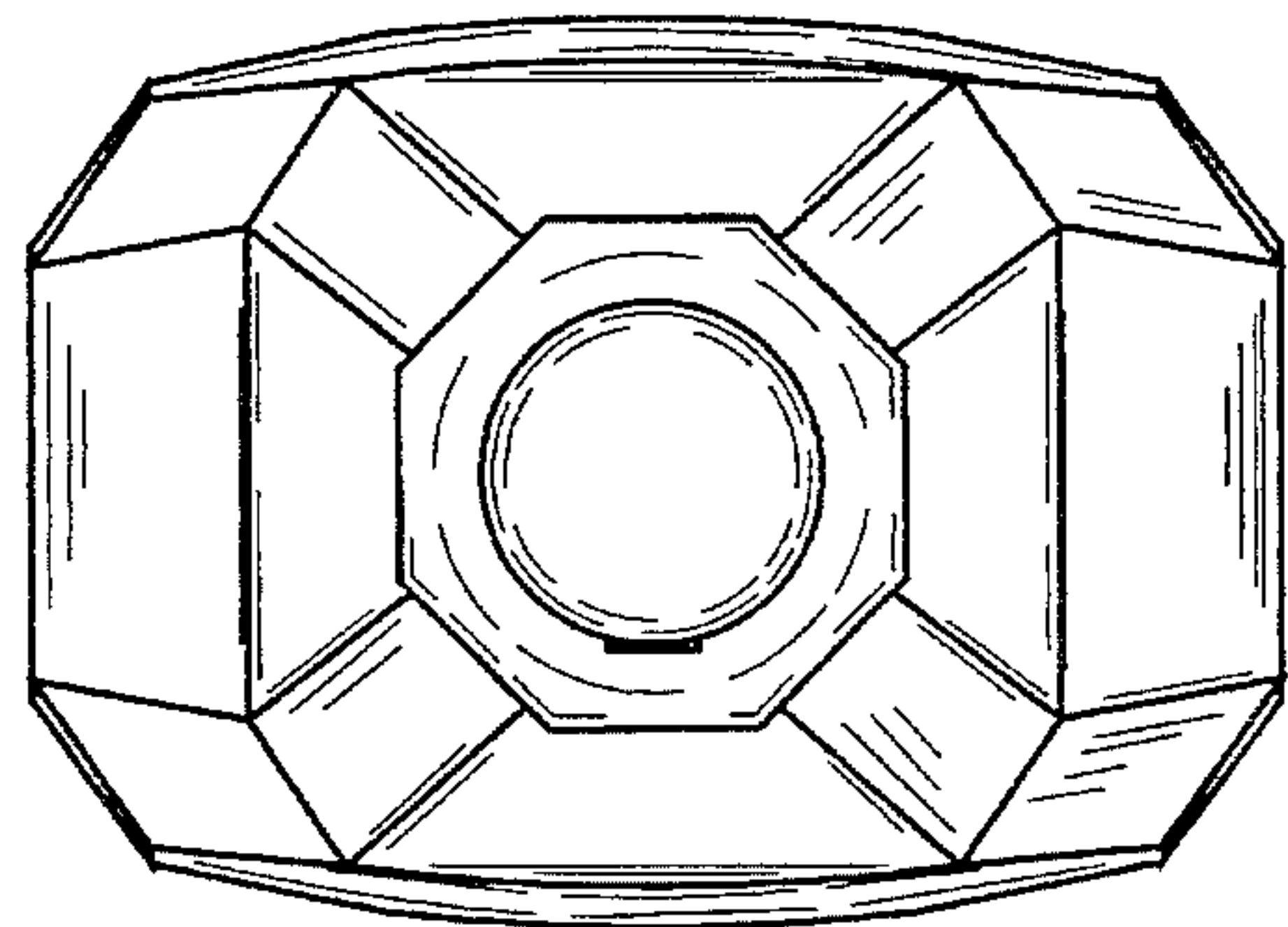

FIG. 20

