



US00D366571S

# United States Patent [19]

Hutton

[11] Patent Number: **Des. 366,571**

[45] Date of Patent: **\*\*Jan. 30, 1996**

[54] CHAISE

[75] Inventor: **John Hutton**, New York, N.Y.

[73] Assignee: **Donghia Furniture**, New York, N.Y.

[\*\*] Term: **14 Years**

[21] Appl. No.: **13,037**

[22] Filed: **Sep. 16, 1993**

[52] U.S. Cl. .... **D6/361**

[58] Field of Search ..... D6/334, 360, 361,  
D6/371, 373, 377, 381, 500, 501, 502;  
297/423.1

### [56] References Cited

#### U.S. PATENT DOCUMENTS

D. 99,959	6/1936	Nathan	.....	D6/377
D. 284,624	7/1986	Culler	.....	D6/371
D. 284,812	7/1986	Culler	.....	D6/371

#### OTHER PUBLICATIONS

Nic. Liesenbein's Sons, ©1921, p. 87, Chaise at top left.  
Karpen Furniture, ©1925, p. 71, Chaise shown bottom center.

Chervan, p. 24, Chaise at top left.

*Primary Examiner*—Alan P. Douglas  
*Assistant Examiner*—Gary D. Watson  
*Attorney, Agent, or Firm*—Kenyon & Kenyon

### [57] CLAIM

The ornamental design for a chaise, as shown and described.

### DESCRIPTION

FIG. 1 is a perspective view of a chaise showing my new design;

FIG. 2 is a front elevational view thereof;

FIG. 3 is a rear elevational view thereof;

FIG. 4 is a left side elevational view thereof;

FIG. 5 is a right side elevational view thereof;

FIG. 6 is a top plan view thereof; and,

FIG. 7 is a bottom plan view thereof.

1 Claim, 6 Drawing Sheets

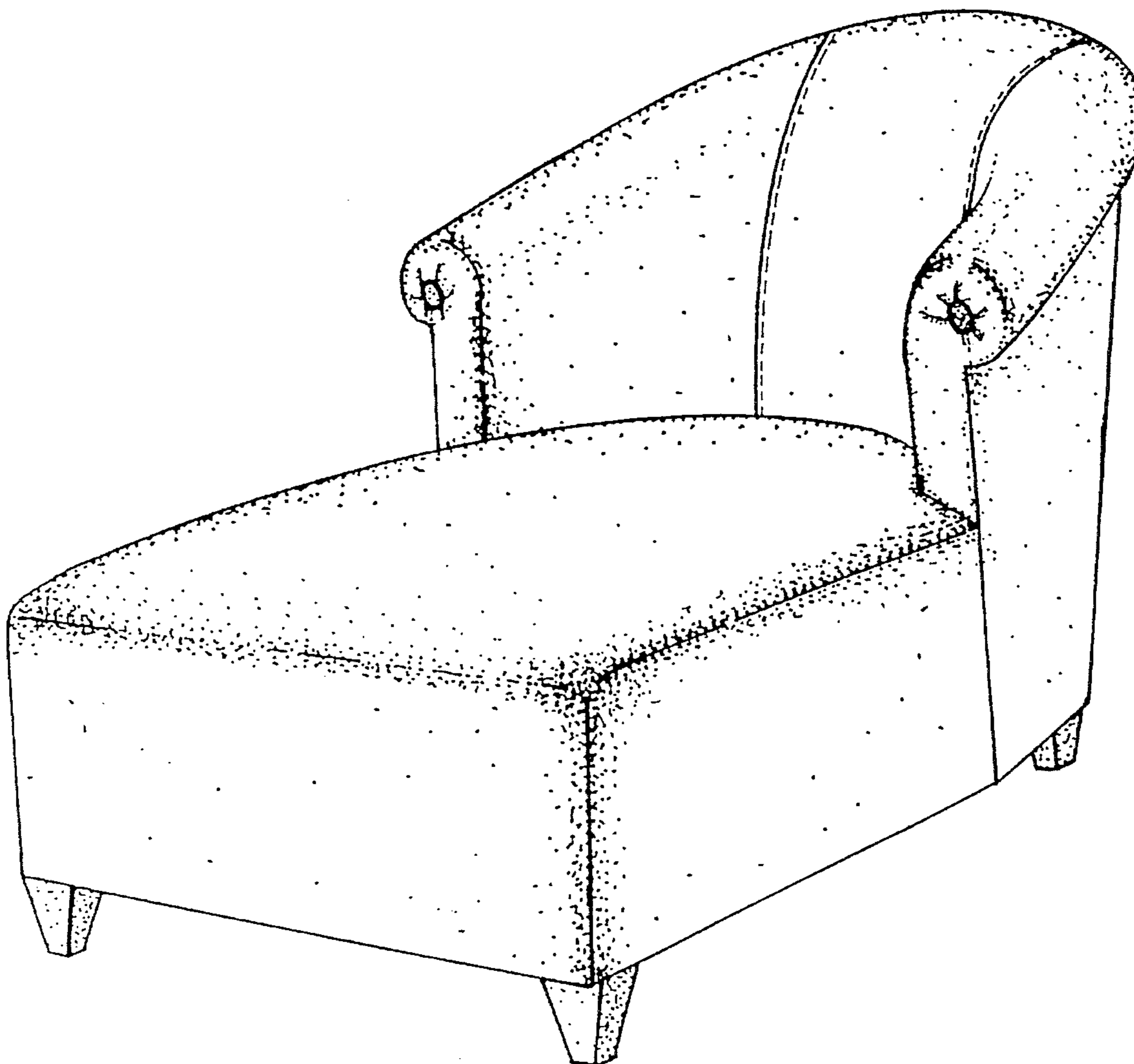

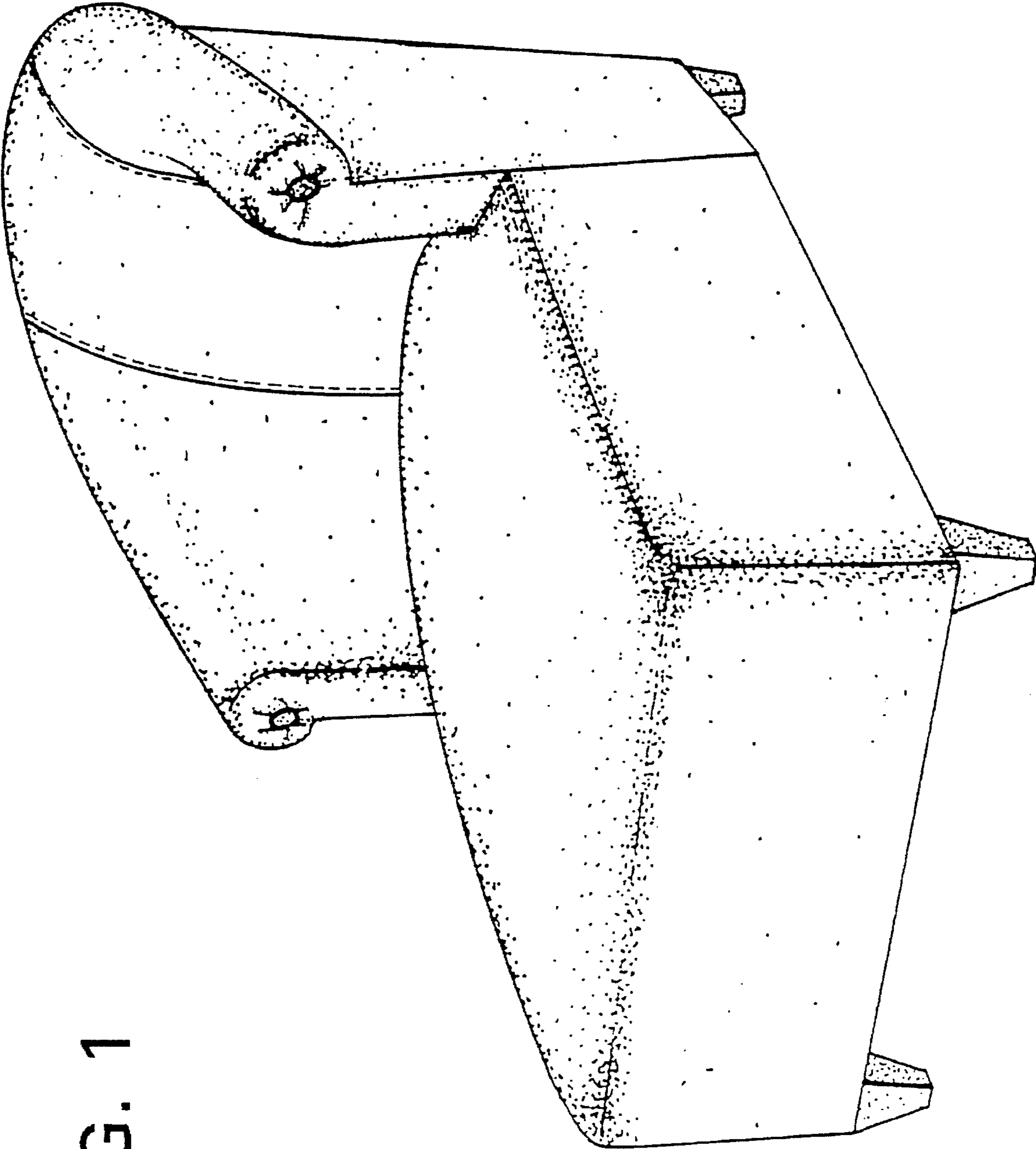

FIG. 1

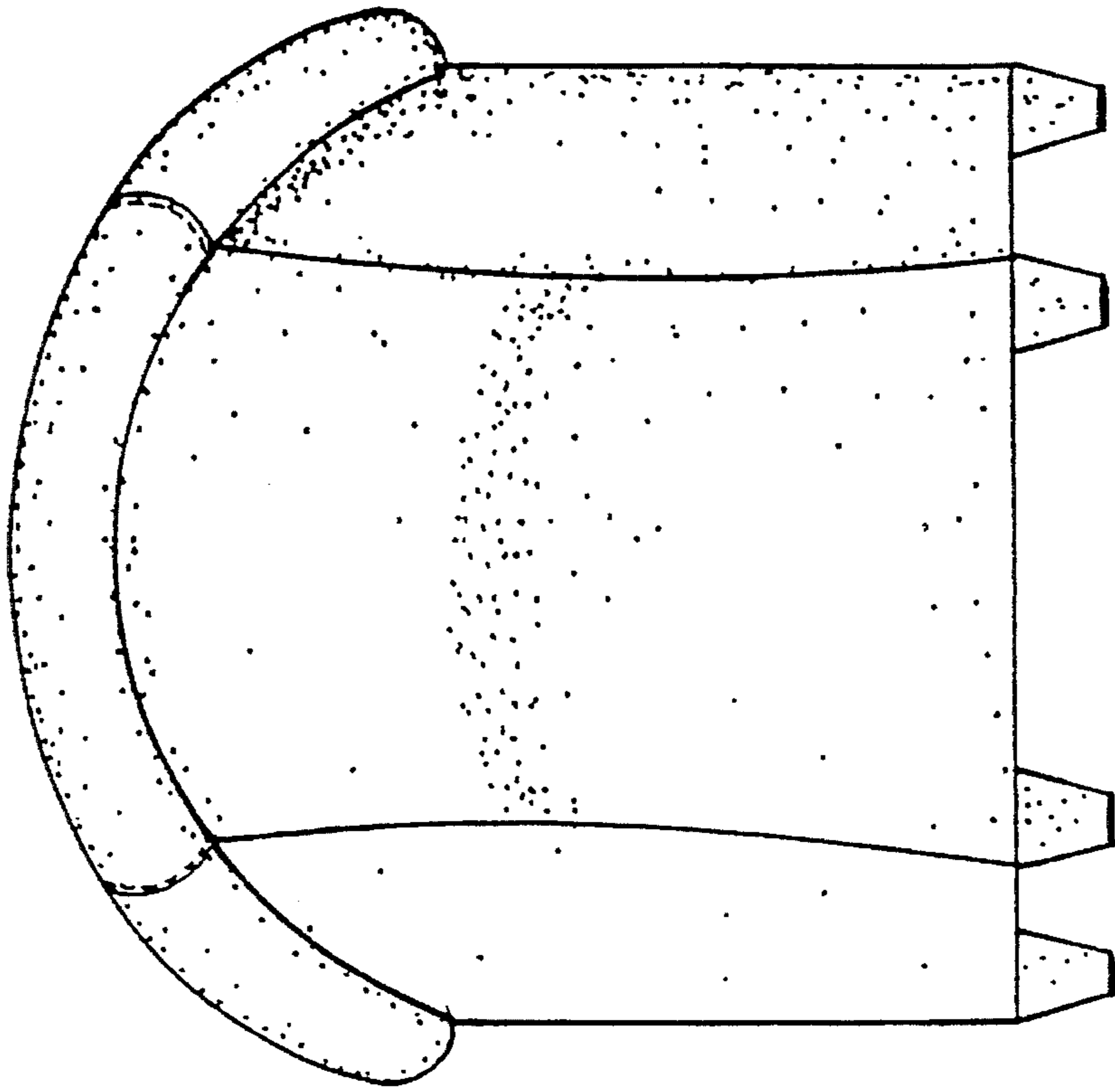

FIG. 3

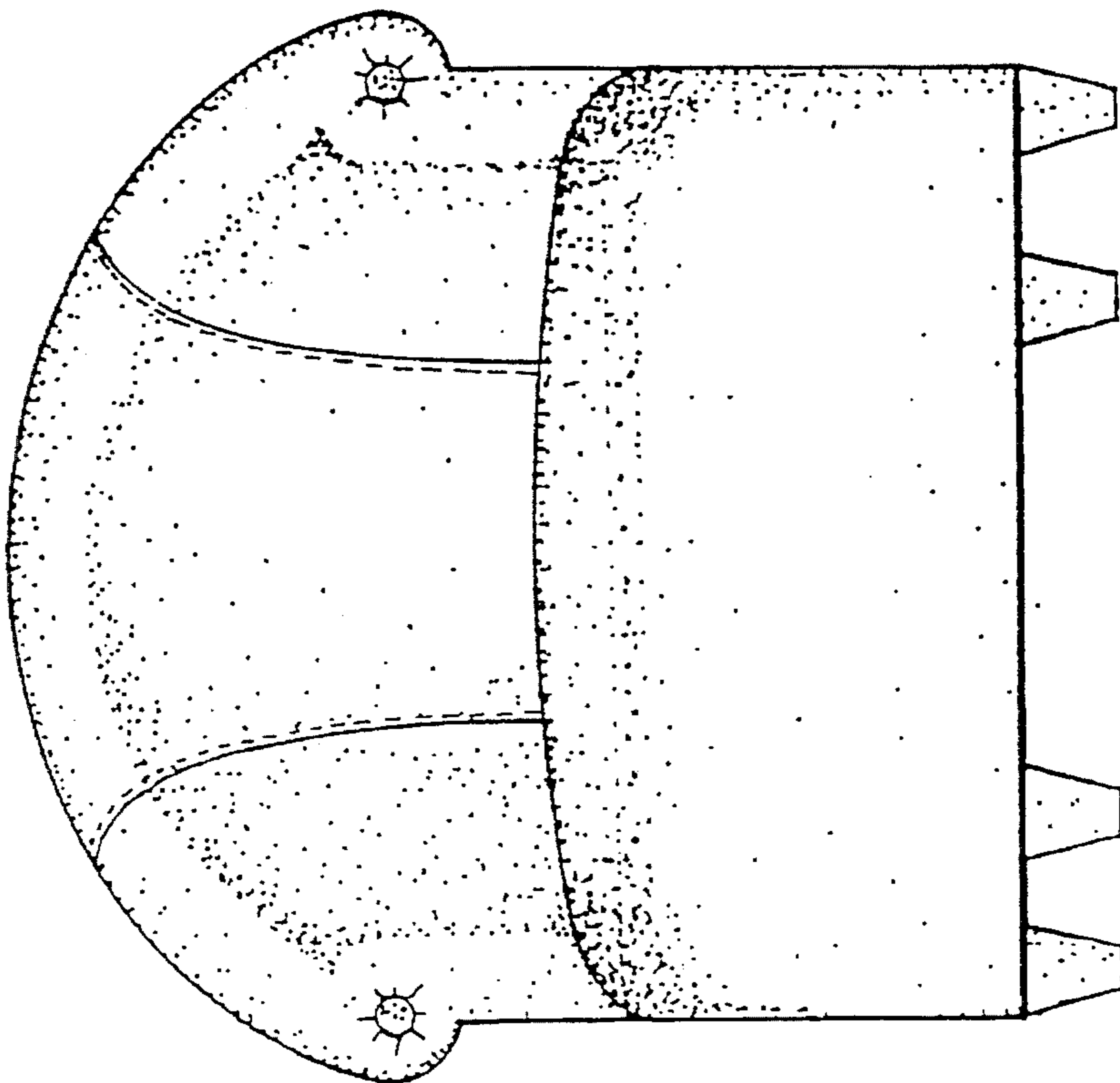

FIG. 2

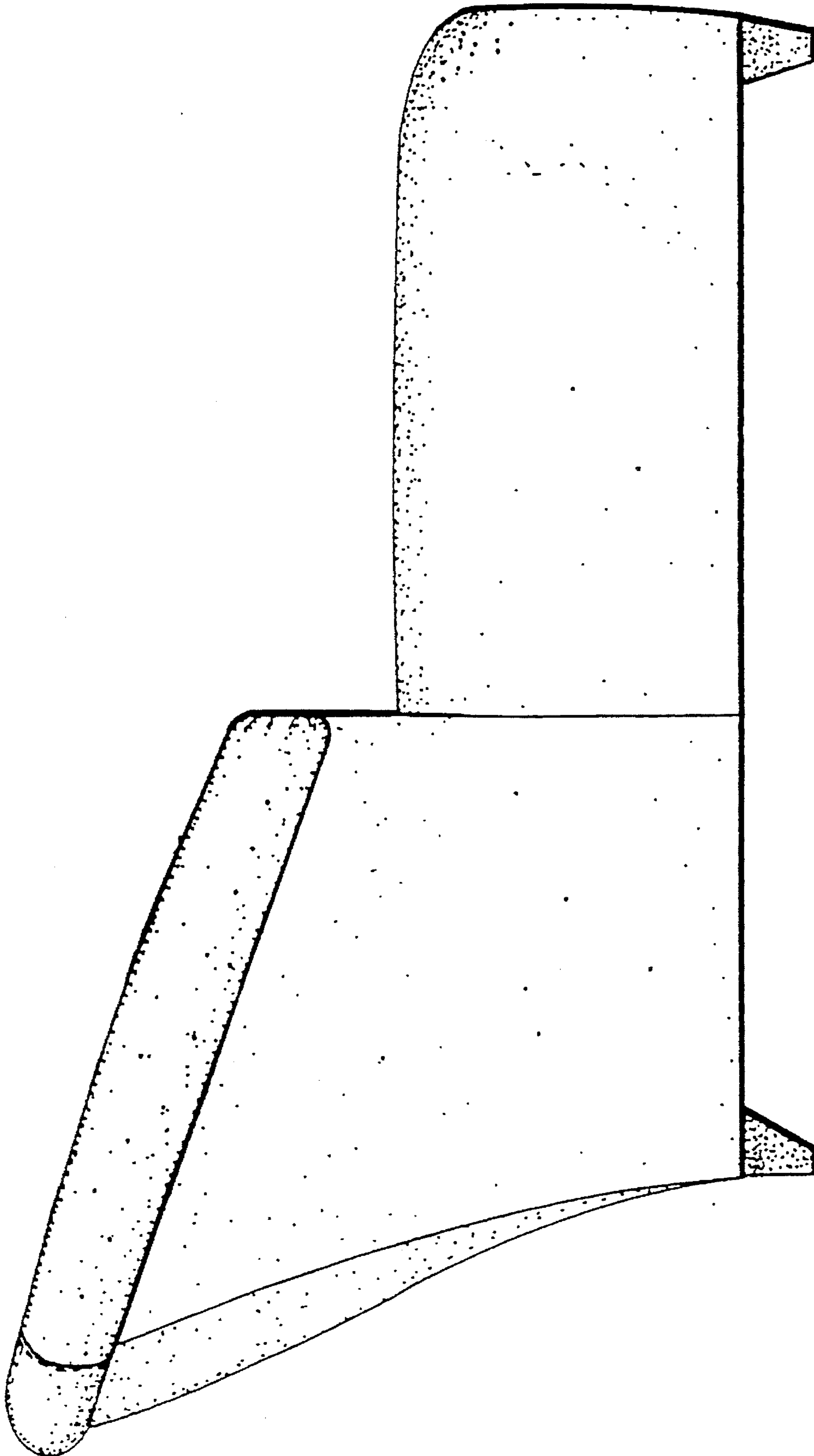

FIG. 4

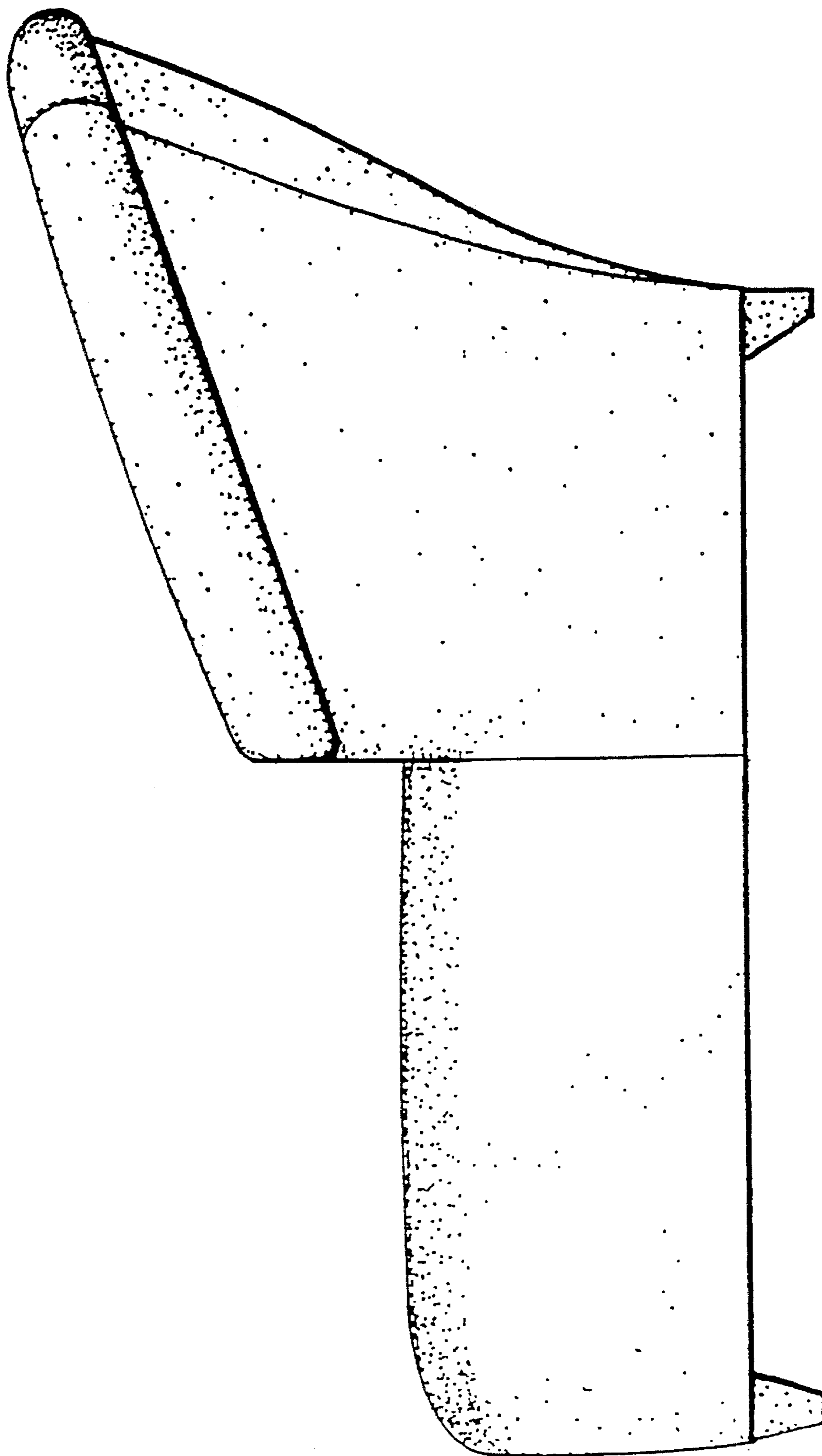

FIG. 5

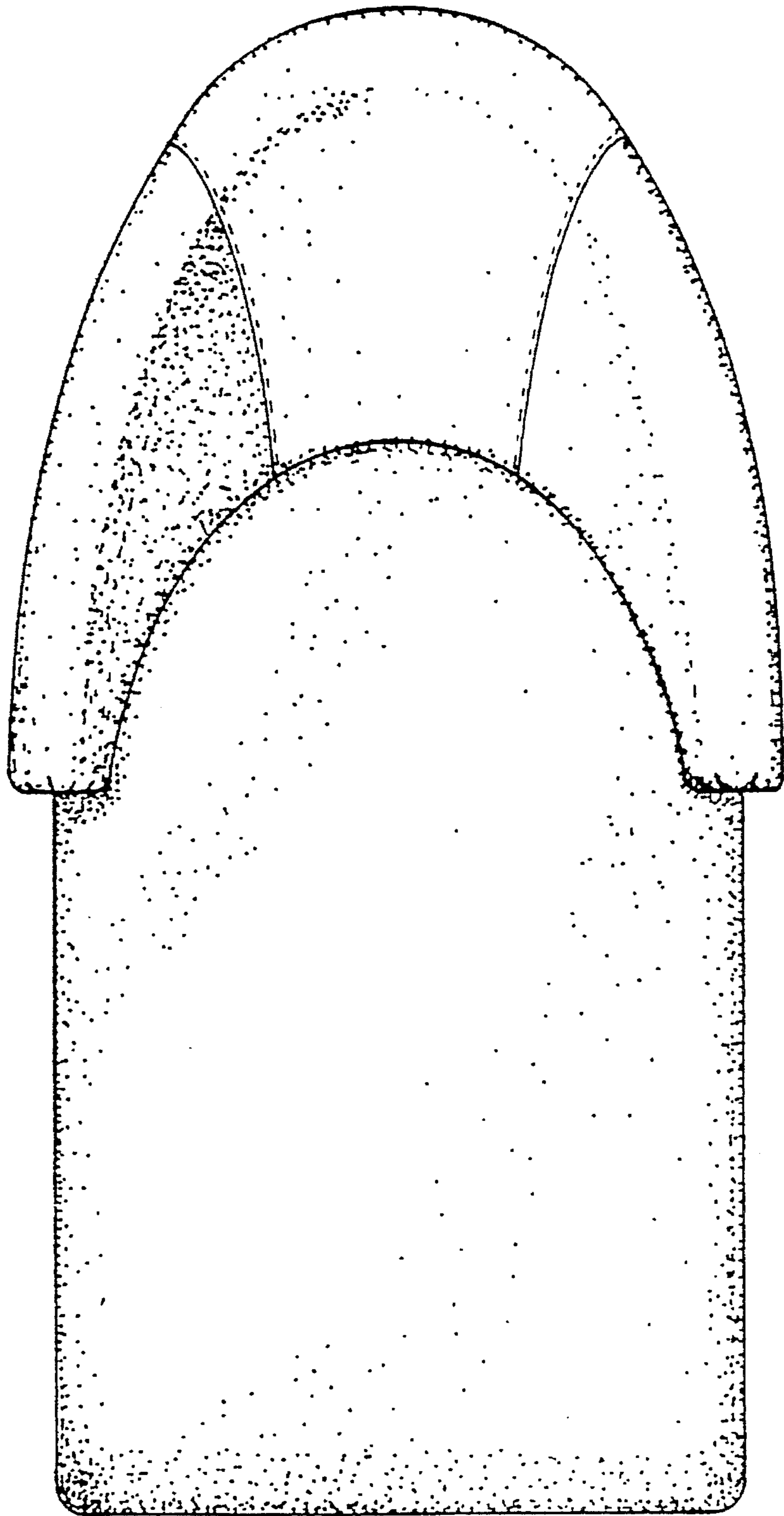

FIG. 6

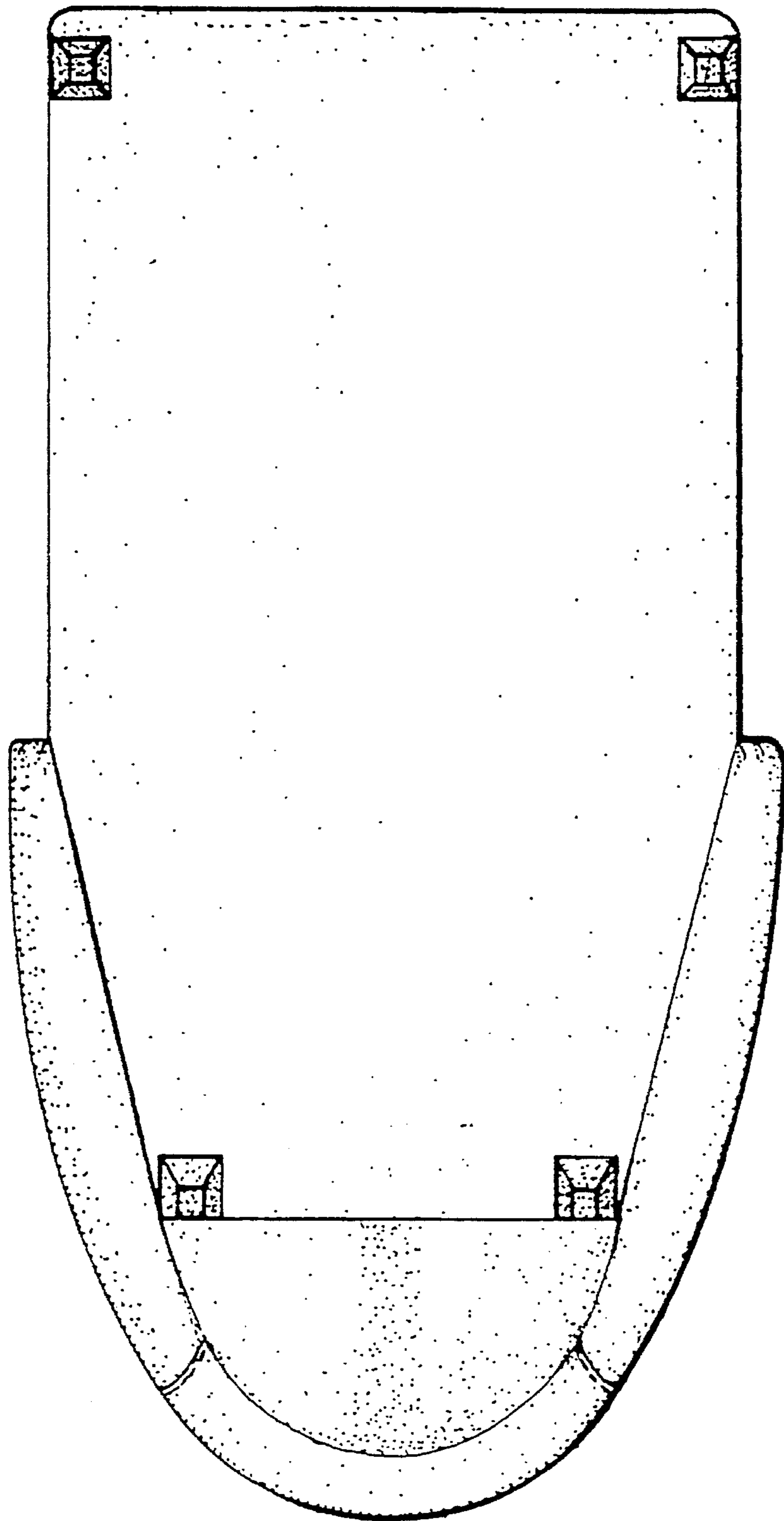

FIG. 7