



US00D366565S

# United States Patent [19] Harper

[11] Patent Number: **Des. 366,565**

[45] Date of Patent: **\*\*Jan. 30, 1996**

[54] **GOLF CLUB HEAD CLEANER**

[76] Inventor: **John Harper**, 28 Wingfield Road,  
Trowbridge Wilts, BA14 9ED, United  
Kingdom

[\*\*] Term: **14 Years**

[21] Appl. No.: **32,827**

[22] Filed: **Dec. 29, 1994**

[52] U.S. Cl. .... **D4/121; D21/234; D32/42**

[58] Field of Search ..... **D4/116, 121, 137,  
D4/199, 130; D32/35, 40, 42, 45; D21/234;  
15/88.1, 88.3, 104.92, 105, 114, 159.1,  
160; 273/32 B**

[56] **References Cited**

**U.S. PATENT DOCUMENTS**

2,744,276	5/1956	Chambless .....	15/104.92
4,734,952	4/1988	Parchment et al. ....	15/104.92
5,081,735	1/1992	Wyatt et al. ....	15/104.92

*Primary Examiner*—A. Hugo Word  
*Assistant Examiner*—Lavone D. Tabor

[57] **CLAIM**

The ornamental design for a golf club head cleaner, as shown and described.

**DESCRIPTION**

FIG. 1 is a top front perspective view of a golf club head cleaner designed in accordance with my invention. A hinge cover is shown in the opened condition in this view;

FIG. 2 is a side elevational view thereof, shown with the cover in closed condition;

FIG. 3 is a rear elevational view of FIG. 2;

FIG. 4 is a front elevational view of FIG. 2;

FIG. 5 is a top plan view of FIG. 2;

FIG. 6 is a bottom plan view of FIG. 2; and,

FIG. 7 is a sectional view taken along line 7—7 of FIG. 1.

**1 Claim, 3 Drawing Sheets**

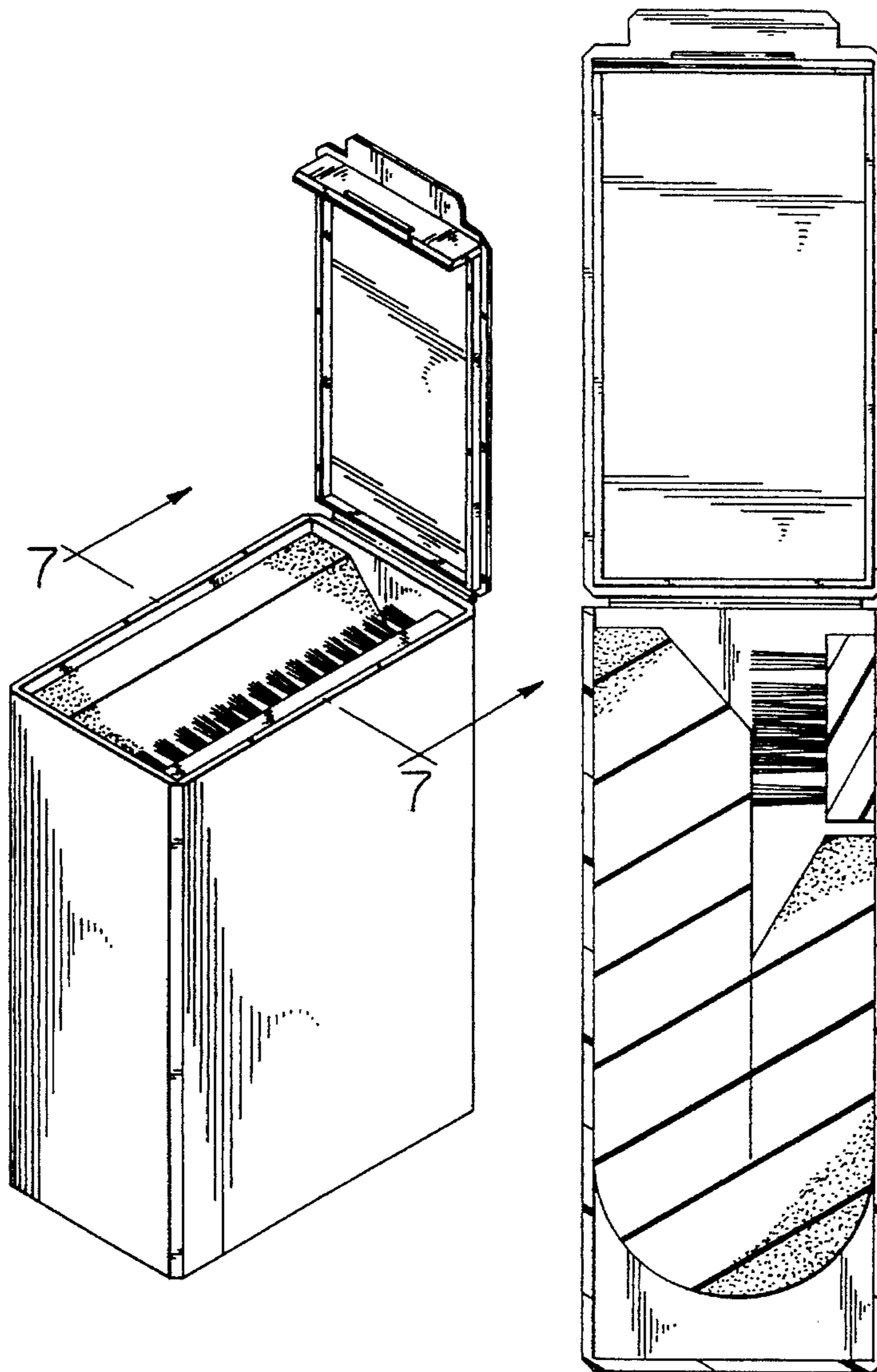

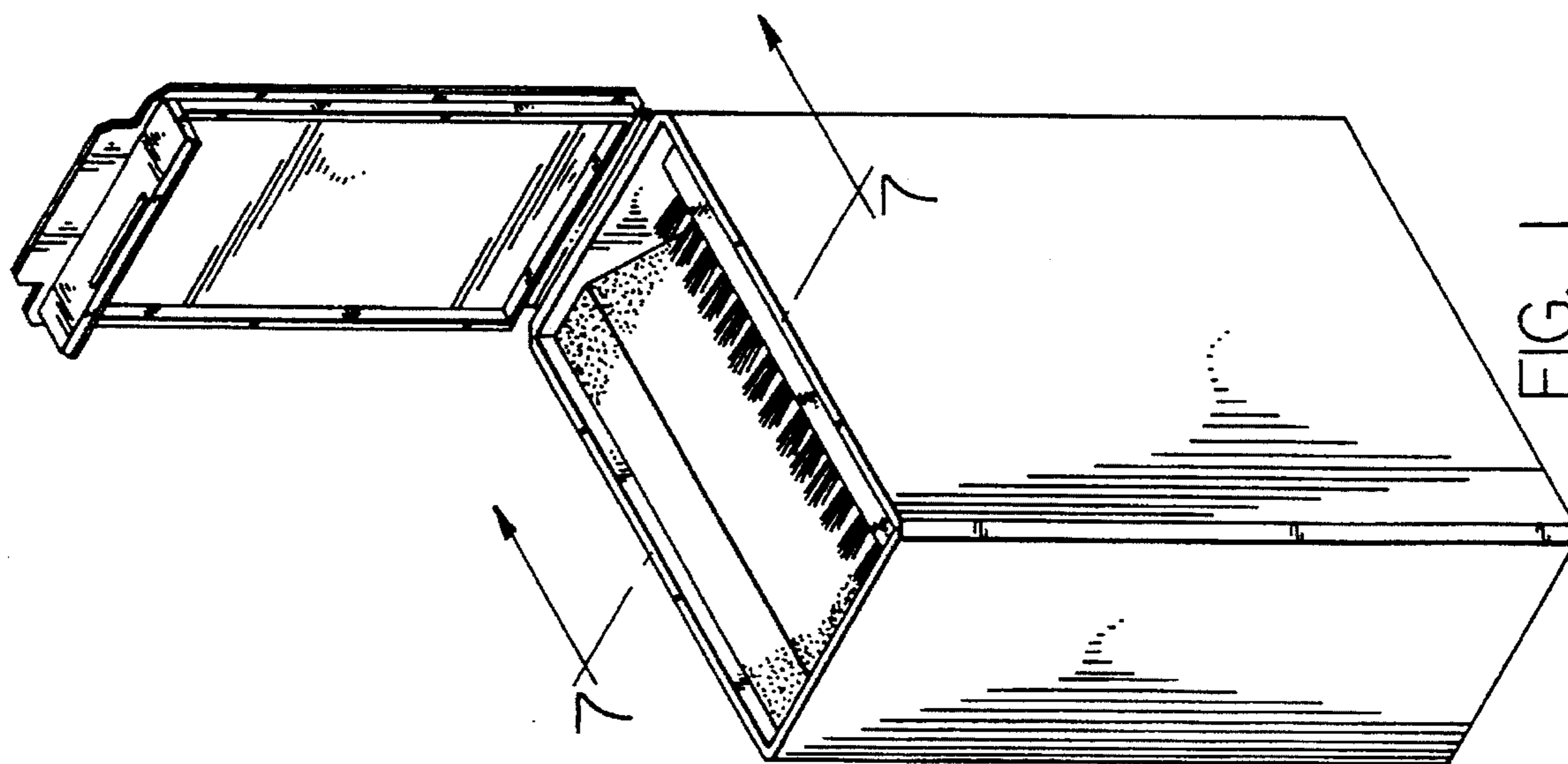

FIG. 1

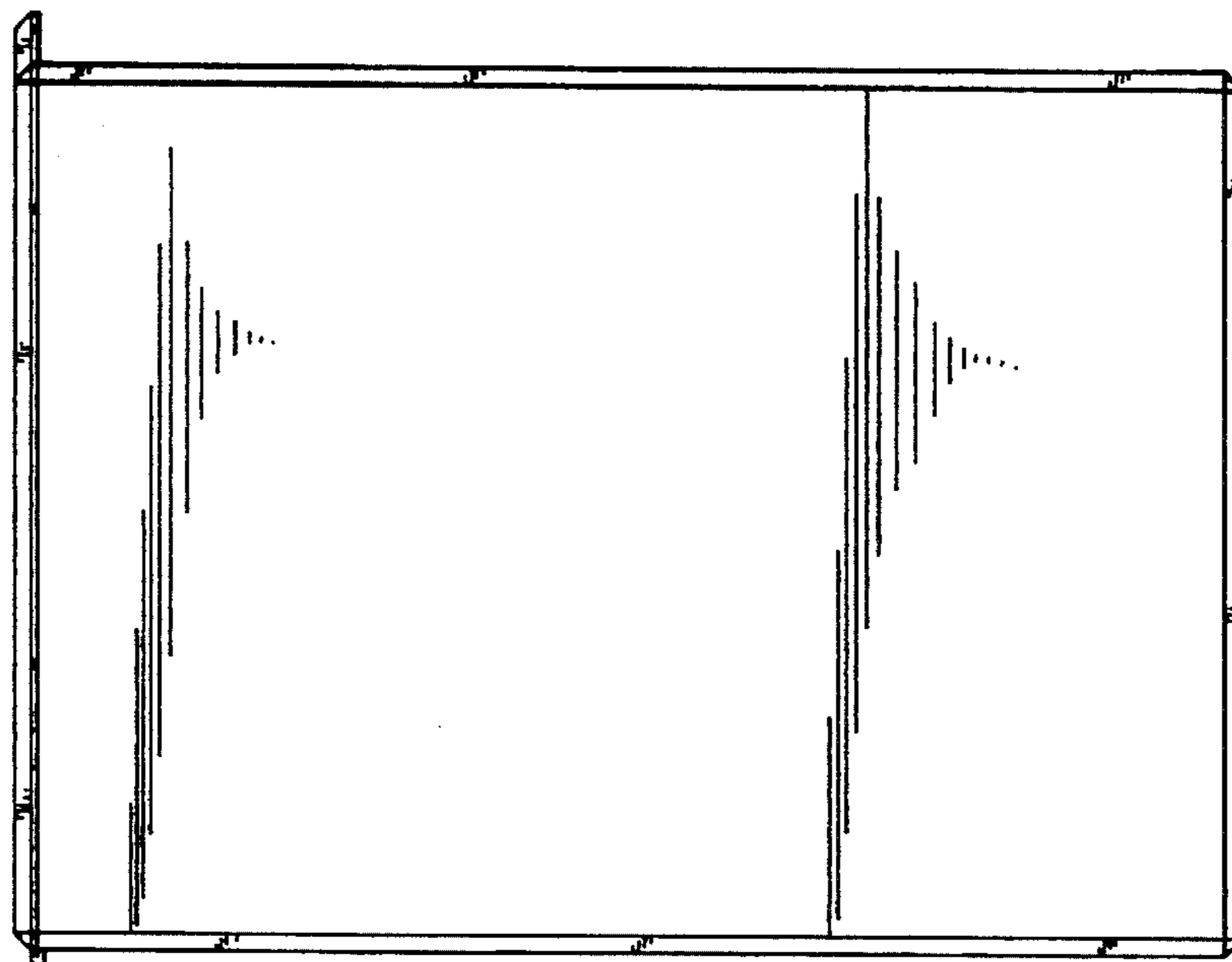

FIG. 2

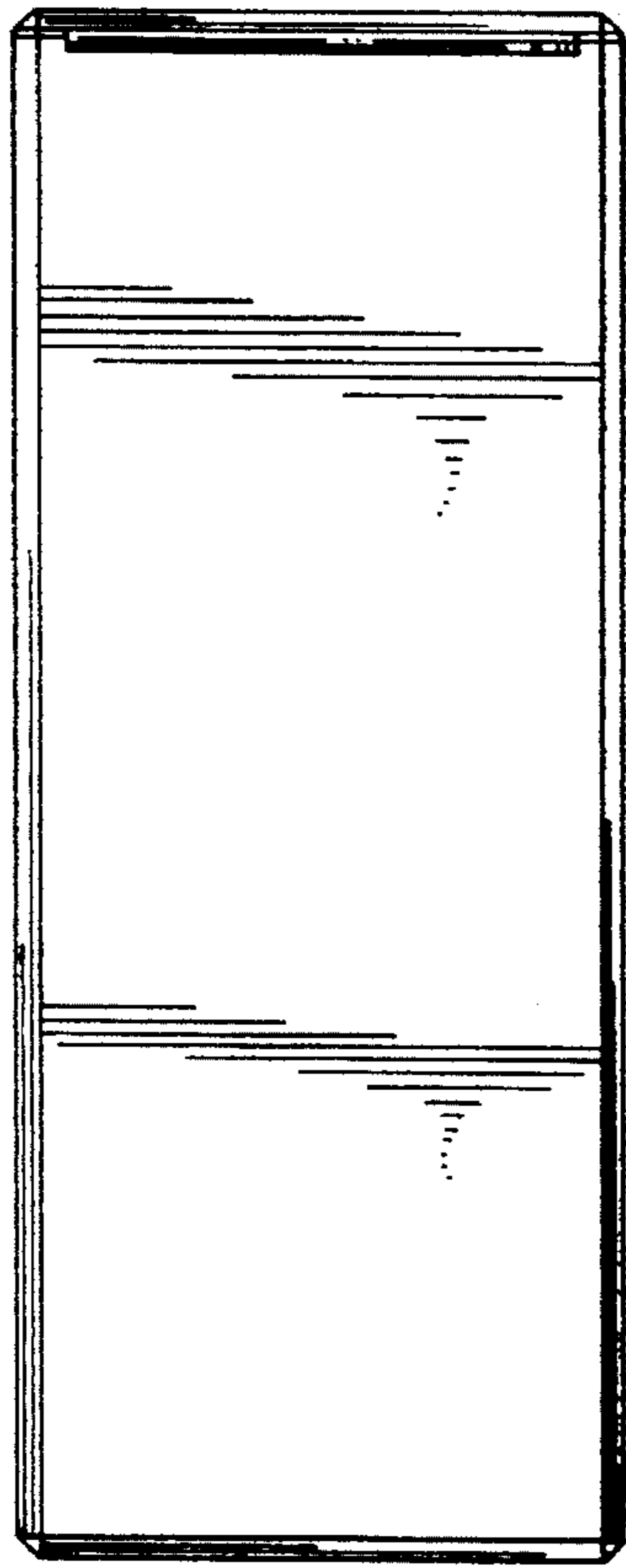

FIG. 3

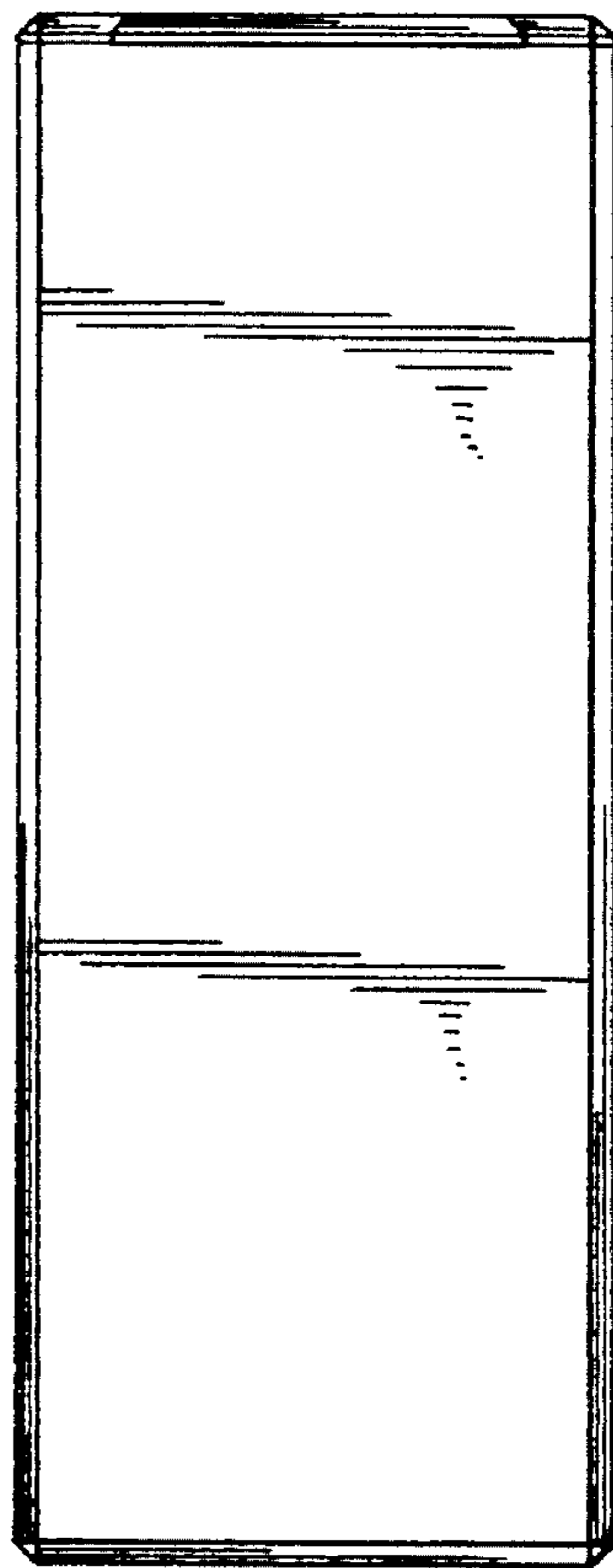

FIG. 4

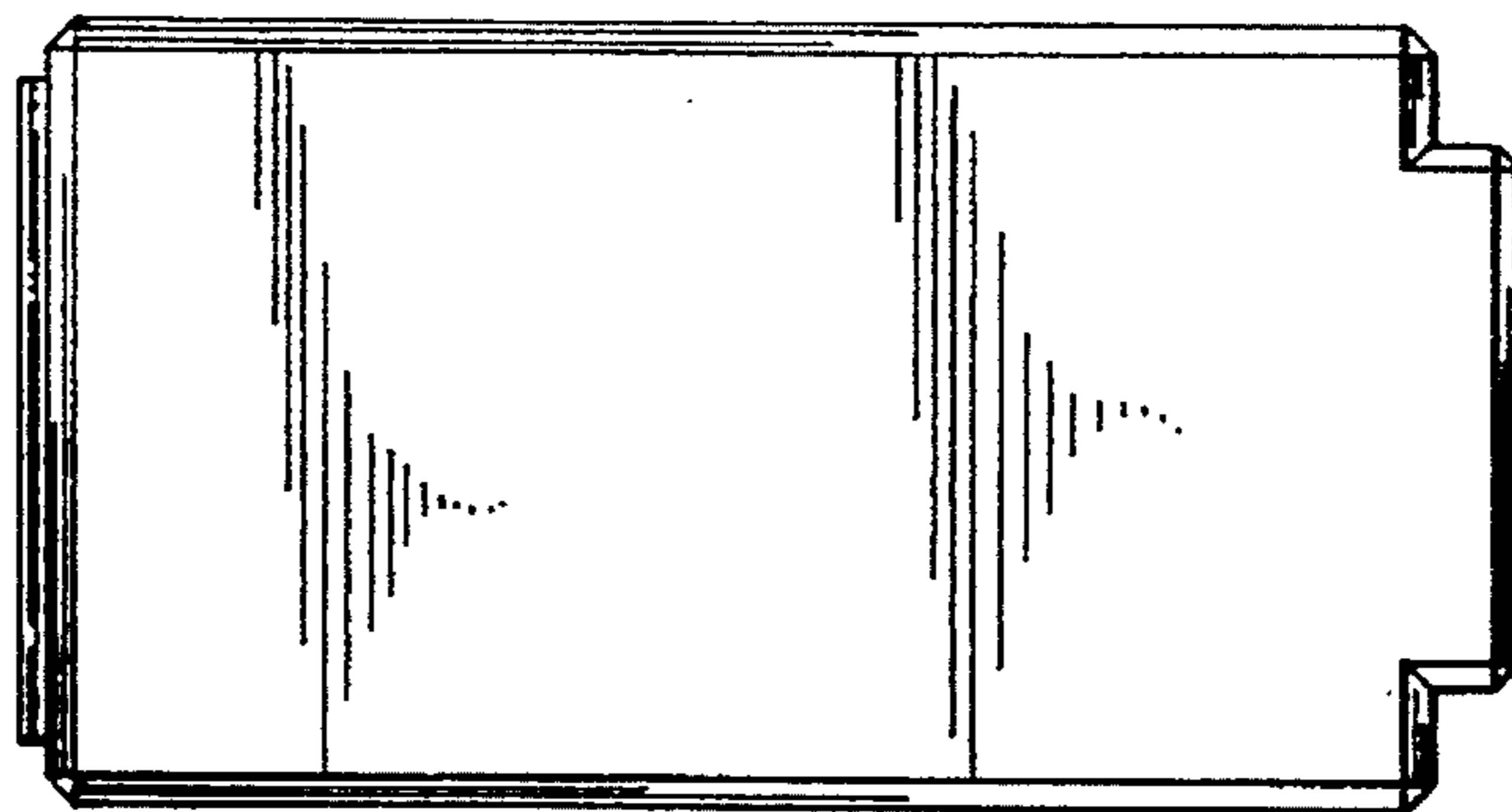

FIG. 5

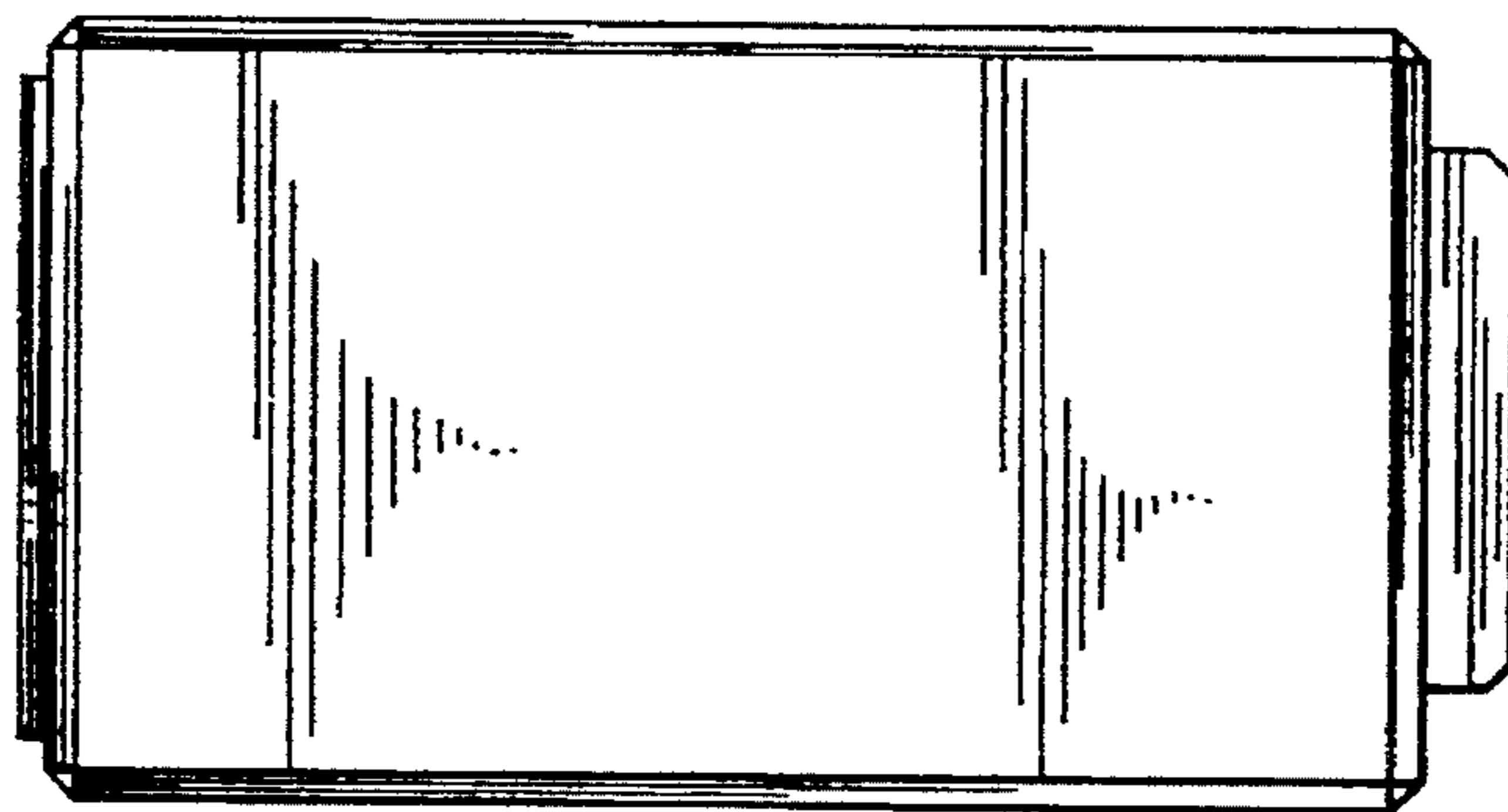

FIG. 6

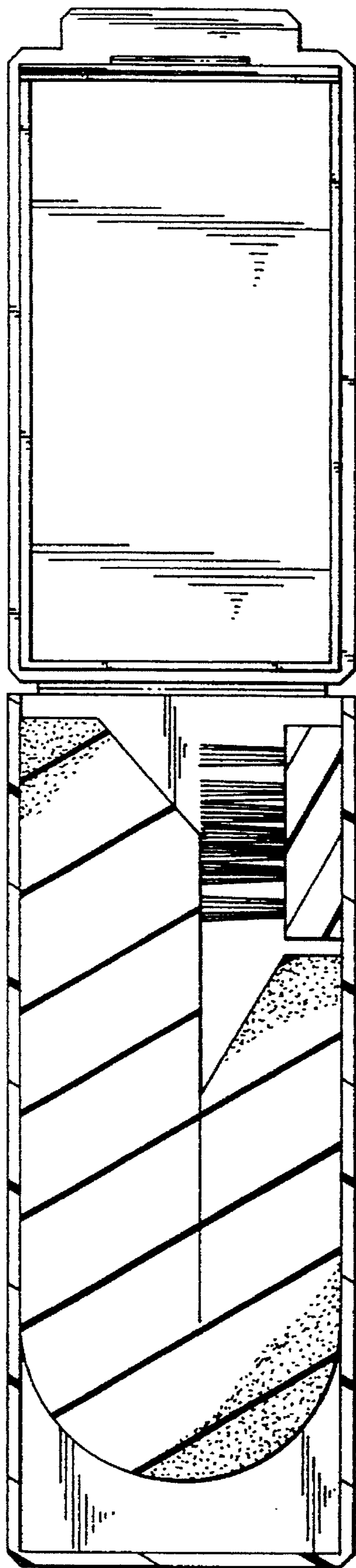

FIG. 7